

Push-to-Connect Couplings

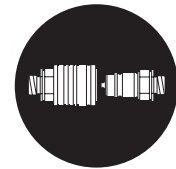

Multi Couplings



Screw-to-Connect Couplings



## Germany

### **Walter Stauffenberg GmbH & Co. KG**

Im Ehrenfeld 4

58791 Werdohl

Tel.: +49 2392 91 60

E-Mail: [sales@stauff.com](mailto:sales@stauff.com)

[www.stauff.com](http://www.stauff.com)

STAUFF products and services are globally available through wholly-owned subsidiaries and a tight network of authorised distributors and representatives in all major industrial regions of the world.

**You can find detailed contact information on the last two pages of this product catalogue or at [www.stauff.com](http://www.stauff.com).**

Please note: Unless otherwise stated, all data and figures in this product catalogue are approximate values and are only valid as references, which are not binding (also in respect to any third parties' rights of protection) and thus do not release the customer / user from checking and testing the suitability of the products for the foreseen purposes. Therefore, data and figures can only be used in a limited sense for construction purposes.

The application of the products is beyond the control possibilities of the manufacturer and, therefore, is exclusively subject to the responsibility of the customer / user.

In the event that a liability is nevertheless considered, any compensation will be limited to the value of the goods supplied by the manufacturer and used by the customer / user. As a matter of course, the manufacturer guarantees the perfect quality of all products in accordance with the General Terms and Conditions of Business and Sale.

Subject to modifications due to the ongoing development and improvement of the products.

With the publication of this product catalogue, previous editions are no longer valid.

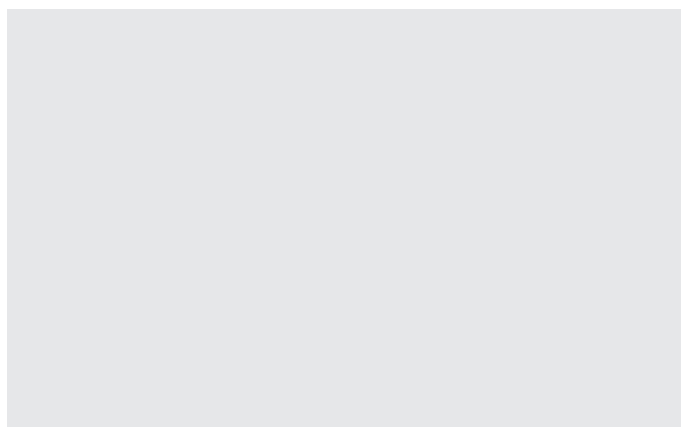
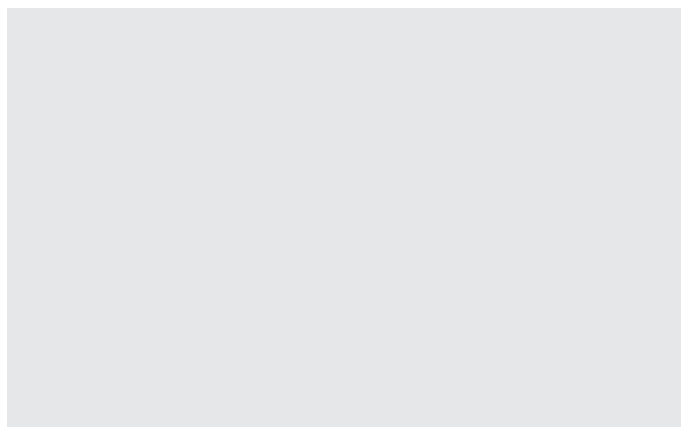

<b>Introduction</b>		4 - 11	
<b>Overview</b> (Product Overview / Structure of the Part Numbers)		12 - 19	
<b>Push-to-Connect Couplings</b>	<b>FF/FH Series</b> ▪ Flat Face Coupling acc. to ISO 16028	21 - 32	<b>FF/FU</b>
	<b>FU Series</b> ▪ Flat Face Coupling acc. to ISO 16028, Connect Under Pressure	29 - 31	
	<b>FH Series</b> ▪ Flat Face Coupling acc. to ISO 16028, Stainless Steel	33 - 36	<b>FH</b>
	<b>FO Series</b> ▪ Flat Face Coupling, Stainless Steel	37 - 40	<b>FO</b>
	<b>HP Series</b> ▪ ISO 7241-1, Series A, Push-Pull	41 - 52	<b>HP/HU</b>
	<b>HU Series</b> ▪ ISO 7241-1, Series A, Push-Pull, Connect Under Pressure	49	
	<b>UX Series</b> ▪ ISO 7241-1, Series A, Push-Pull, Connect Under Pressure	53 - 56	<b>UX</b>
	<b>IA Series</b> ▪ ISO 7241-1, Series A	57 - 62	<b>IA</b>
	<b>IA Series</b> ▪ ISO 7241-1, Series A, Stainless Steel	63 - 68	
	<b>IB Series</b> ▪ ISO 7241-1, Series B	69 - 74	<b>IB</b>
	<b>IB Series</b> ▪ ISO 7241-1, Series B, Brass	75 - 80	
	<b>IB Series</b> ▪ ISO 7241-1, Series B, Stainless Steel	81 - 86	
	<b>ID Series</b>	87 - 90	<b>ID</b>
	<b>BP Series</b> ▪ ISO 5676	91 - 94	<b>BP</b>
	<b>HC Series</b> ▪ Flat Face Coupling	95 - 98	<b>HC</b>
	<b>HD Series</b> ▪ Flat Face Coupling	99 - 102	<b>HD</b>
<b>HUS Series</b> ▪ Nordic Interchange Design	103 - 105	<b>HUS</b>	
<b>Multi Couplings</b>	<b>MK Series</b> ▪ Multicoupling System, Flat Face Coupling	107 - 111	<b>MK</b>
<b>Screw-to-Connect Couplings</b>	<b>HS Series</b> ▪ ISO 14541	113 - 124	<b>HS</b>
	<b>HS Series</b> ▪ ISO 14541, Stainless Steel	125 - 130	
	<b>PS Series</b> ▪ For Hammer Application	131 - 134	<b>PS</b>
	<b>RH Series</b> ▪ Flat Face Coupling, Pipeline Coupling	135 - 140	<b>RH</b>
	<b>FT Series</b> ▪ Flat Face Coupling, Connect Under Pressure	141 - 146	<b>FT</b>
	<b>HR Series</b>	147 - 152	<b>HR</b>
	<b>HH Series</b>	153 - 158	<b>HH</b>
	<b>HH Series</b> ▪ Stainless Steel	159 - 164	
	<b>HI (HIB) Series</b> ▪ ISO 14540	165 - 168	<b>HI</b>
	<b>HT Series</b> ▪ Wing Style	169 - 172	<b>HT</b>
<b>HM Series</b> ▪ Wing Style	173 - 176	<b>HM</b>	
<b>HV Series</b> ▪ Wing Style	177 - 181	<b>HV</b>	
<b>Special Applications</b>		183 - 185	
<b>Spare Parts / Accessories</b>		187 - 191	
<b>Technical Appendix</b>		193 - 195	
<b>Appendix</b> (Product-Specific Abbreviations / Global Contact Directory)		197 - 203	





### Catalogue 1 STAUFF Clamps

- Block Clamps
- Special Clamps
- Light Series Clamps
- Saddle Clamps
- U-Bolt Clamps
- Metal Clamps
- Construction Series



### Catalogue 2 STAUFF Connect

- Tube Connectors
- Assembly Tools and Devices

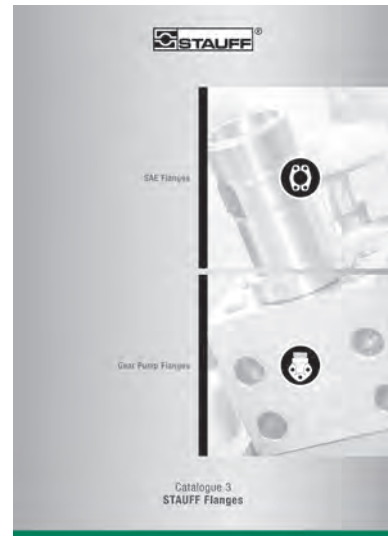

### Catalogue 3 STAUFF Flanges

- SAE Flanges
- Gear Pump Flanges



### Catalogue 4 STAUFF Hose Connectors

- Hose Connectors
- High-Pressure Hose Connectors

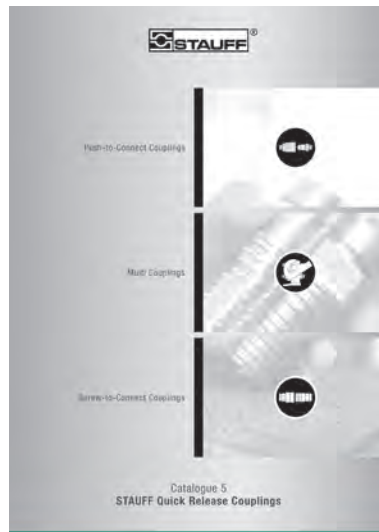

### Catalogue 5 STAUFF Quick Release Couplings

- Push-to-Connect Couplings
- Multi Couplings
- Screw-to-Connect Couplings



### Catalogue 6 STAUFF Valves

- Two-Way Ball Valves
- Multi-Way Ball Valves
- Flow Control and Check Valves
- Gauge Isolator Valves





### Catalogue 7 STAUFF Test

- Test Couplings
- Test Adaptors
- Test Hoses and Connectors



### Catalogue 8 STAUFF Diagtronics

- Pressure Gauges
- Hydraulic Testers
- Oil Analysis Equipment



### Catalogue 9 STAUFF Filtration Technology

- Replacement Filter Elements
- Pressure Filters
- Return-Line Filters
- In-Line Filters
- Spin-On Filters
- Offline and Bypass Filters
- Filtration Systems

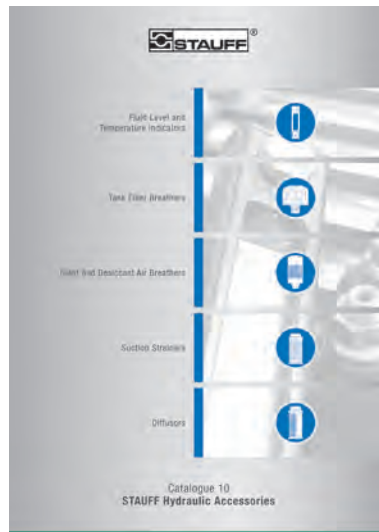

### Catalogue 10 STAUFF Hydraulic Accessories

- Fluid Level and Temperature Indicators
- Tank Filler Breathers
- Giant and Desiccant Air Breathers
- Suction Strainers
- Diffusers



For more than 50 years, the companies of STAUFF Group have been developing, manufacturing and distributing pipework equipment and hydraulic components for mechanical and plant engineering and for service and industrial maintenance.

In addition to mobile and industrial hydraulic machinery, typical applications also include commercial and special purpose vehicles, rail transportation and energy technology. Likewise, STAUFF products are used in marine, oil and gas applications and in the process, food and chemical industries.

The overall range currently includes about 50000 standard products as well as numerous special and system solutions according to customer's specifications or based on our in-house development.

All STAUFF products undergo relevant testing in accordance with international regulations and are governed by the high standards of the in-house quality management system. Furthermore, many items have received certifications and approvals from various international institutes, organisations and authorities who have independently confirmed the quality and performance of the products.

Wholly-owned manufacturing, sales and service facilities in 18 countries and a tight global network of authorised distribution partners ensure high presence and service paired with a maximum of availability.



Lloyd's Register  
LRQA

Quality Management – ISO 9001:2015  
Environmental Management – ISO 14001:2015  
Safety Management – ISO 45001:2018  
Energy Management – ISO 50001:2018

## STAUFF LINE Components

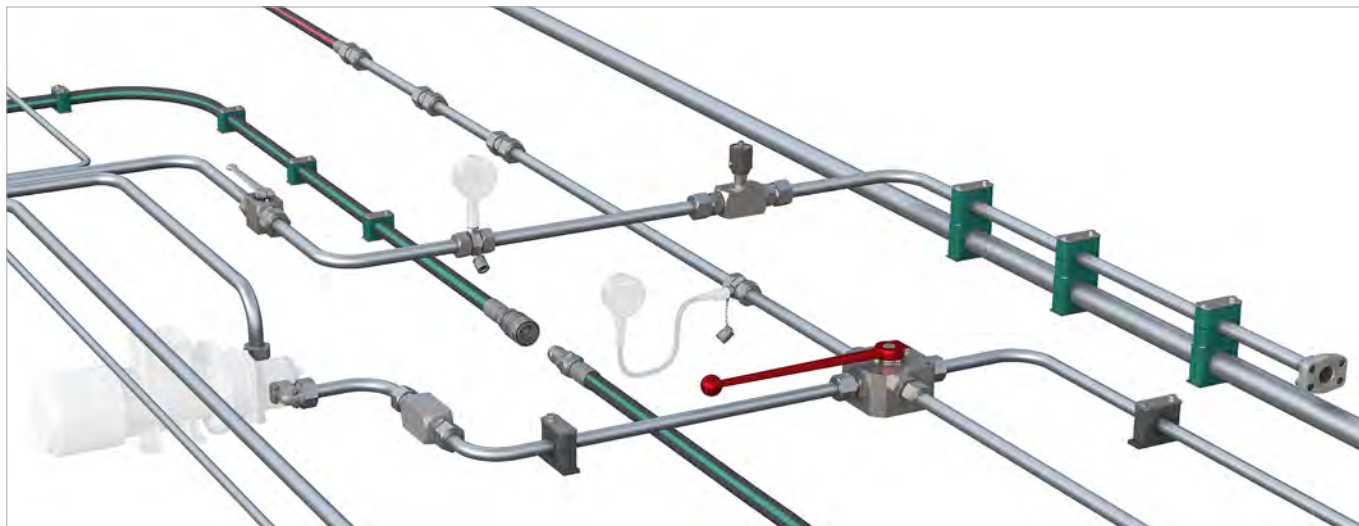

With the seven dedicated **STAUFF Line** product groups

- **STAUFF Clamps**
- **STAUFF Connect**
- **STAUFF Flanges**
- **STAUFF Hose Connectors**
- **STAUFF Quick Release Couplings**
- **STAUFF Valves**
- **STAUFF Test**

from own, in-house development and manufacturing, the companies of the STAUFF Group provide a comprehensive range of components for fastening and connecting pipes, tubes and hoses for mobile and industrial hydraulic applications and many other industries.

The portfolio is completed by components for shutting-off, regulating, throttling and measuring fluid media.

In order to perfectly match each other, STAUFF Line products are designed and offered on a high, uniform level of quality. A large proportion of the range made from steel comes as standard with the premium STAUFF Zinc/Nickel surface coating, which is also optionally available for many of the other components.

This coating offers the most reliable surface protection far beyond the previous market standards – even after transport, handling and assembly of the components – and meets all current legal requirements.

If desired, Original Equipment Manufacturers can be supported with value-added services, from **technical consultation to pre-assembly, assembly and kitting** as well as **logistics services**:

- Support with the **selection of suitable standard components** and ordering options; provision of **customised solutions** according to customer's specifications or based on our in-house development – from prototyping to large scale production
- **Analysis and optimization** of existing and design and developments of new systems aimed at increasing the efficiency and performance of machines and equipment and creating value for customers by reducing the total cost
- **Pre-assembly, assembly and kitting** of individual components to customer-specific system modules
- Individually coordinated **procurement solutions** (e.g. web shop and electronic data interchange) and **supply models** (e.g. from warehousing of customised components to Kanban logistics and just-in-time delivery of pre-fabricated system modules to the assembly lines of the customers) aimed at optimising material flows



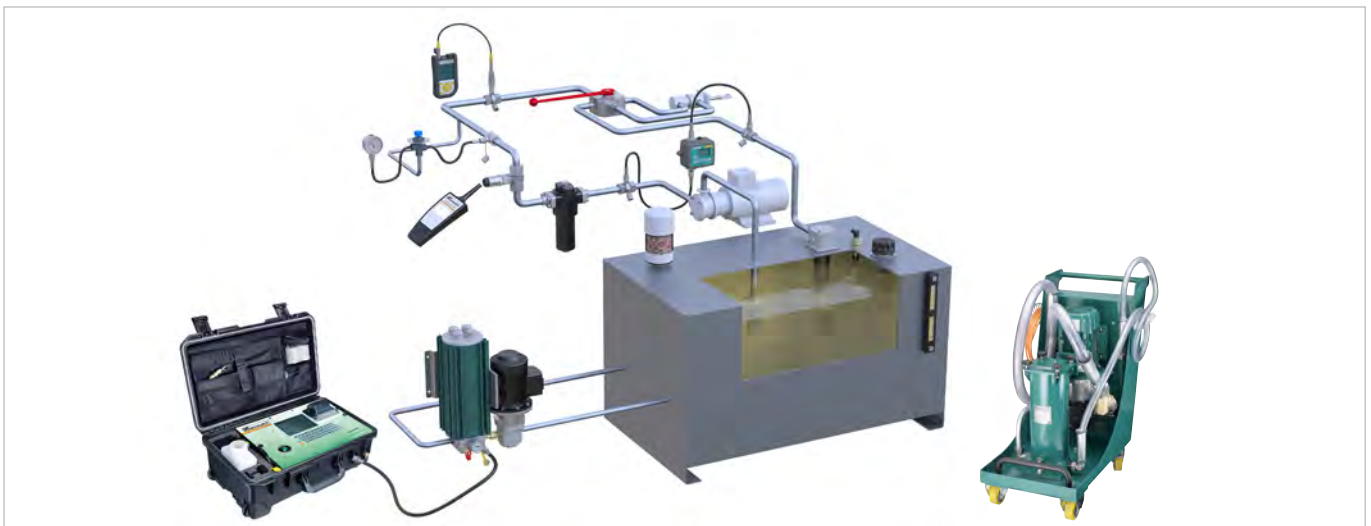

Aligned with the needs of the market, the product groups

- **STAUFF Test**
- **STAUFF Diagtronics**
- **STAUFF Filtration Technology**
- **STAUFF Hydraulic Accessories**

include a comprehensive range of analogue and digital measuring equipment and devices, filtration systems and replacement filter elements as well as accessories for the construction of tanks, reservoirs, power packs and gear boxes in mobile and industrial hydraulics.

The offer is completed by relevant value-added services:

- Support with the **selection of suitable components** and ordering options; provision of **customised solutions** according to customer's specifications or based on our in-house development – from prototyping to large scale production
- Analysis of existing hydraulic circuits aimed at filtration systems, tank components and monitoring devices that perfectly match to the specific requirements, and developing integrated concepts to increase the efficiency and performance of machines and equipment
- Individually coordinated **procurement solutions** and **supply models**



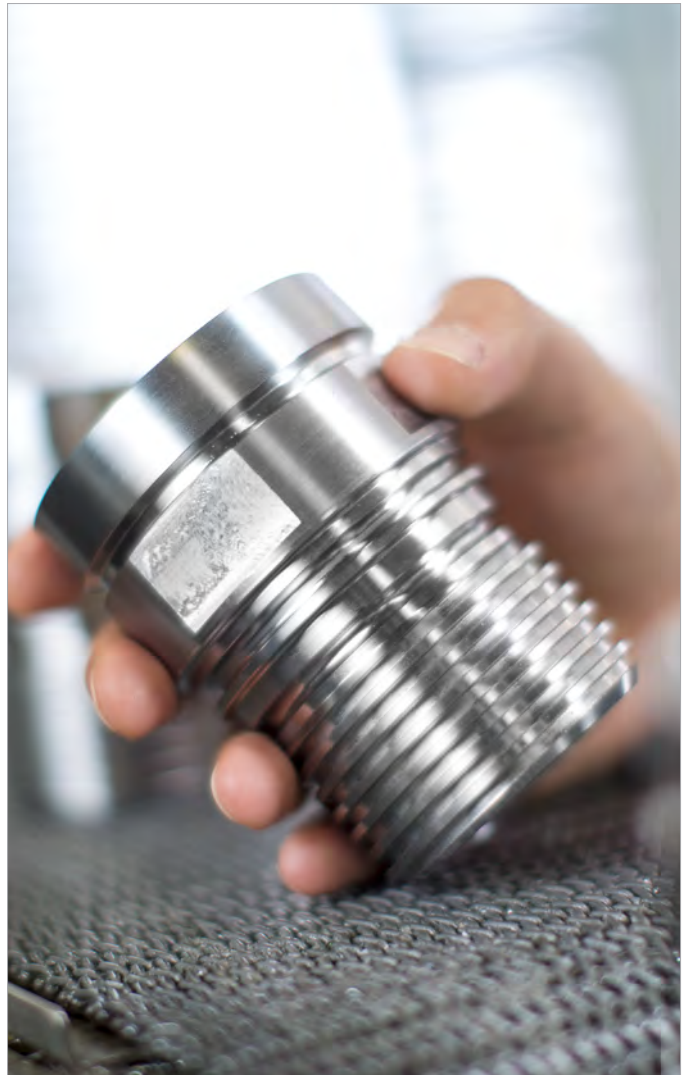

## STAUFF Quick Release Couplings

STAUFF couplings have proven their value for many years in practical use in hydraulic systems. The excellent quality of the couplings is the result of continual product improvement in which the experiences of users have been taken into consideration, as well. Our high production standards, combined with our quality management system certified in accordance with EN ISO 9001, assures the quality of our products.

For the technical specifications of the individual couplings please refer to the following pages of the catalog.

### Housing material

Steel according to EN 10277:  
Couplings Series FF, FU, HP-10, IA, IB, ID, BP, HUS, PS, RK/RH, FT, HH, HI, HT and MK with Zinc-Nickel coating,

Zinc-Plating and Thick-Film-Passivation  
(Chrome III)

### Seals

NBR (Buna-N®), PTFE  
ISO 3601

### Operating temperature

-25 °C ... +100 °C / -13° F ... +212° F  
with NBR (Buna-N®), PTFE  
-25 °C ... +200 °C / -13° F ... +392° F  
with FKM (Viton®)

Please contact STAUFF to require other combinations of materials.

The operating pressures specified in our catalog relate to the strength of the housing components. Standardized connector shapes may have other rated pressures, which cannot automatically be applied to the particular coupling type.

Any remodeling and modification of the couplings are prohibited. By any maintenance of our couplings it's necessary to use original STAUFF parts. In case of using of no original parts or disassembling of the couplings the warranty will be expire.

The STAUFF hydraulic couplings don't have the 94/7/EG guidance for the using in explosive field. The couplings don't have an own ignition source which could be a reason of inflame.







- Free of hexavalent chrome Cr(VI)
- ELV compliant according to 2000/53/EC (End of Life Vehicles Directive)
- REACH compliant according to 1907/2006/EC (Registration, Evaluation, Authorisation and Restriction of Chemicals)
- RoHS compliant according to 2002/95/EC (Restrictions of the Use of Hazardous Substances)



**Normative references**

- EN ISO 8330:2000, ISO 5675, ISO 5676, ISO 7241, ISO 16028, AMD 1





## [www.stauff.com/catalogues](http://www.stauff.com/catalogues)

The STAUFF online catalogue centre at [www.stauff.com/catalogues](http://www.stauff.com/catalogues) provides fast and direct access to digital versions of this as well as other STAUFF product catalogues in all available languages.

### Online Page-Flip Catalogues

- Easy navigation through index or the powerful full text search functionality
- Contents can be shared and forwarded by e-mail, printed or downloaded and saved in PDF file format
- Also suitable for mobile devices

### Download Catalogues

- Download entire product catalogues and save them in PDF file format

### Catalogue Request

- Contact form to request printed copies of the product catalogue as well as digital copies on USB stick

The fastest way to the online page-flip catalogue:

The links that can be found at the bottom edge of all pages of this product catalogue will lead you directly to the corresponding page in the online page-flip catalogue.

In doing so, contents can be searched, shared and forwarded by e-mail, printed or downloaded and saved in PDF file format.

Scan the QR code next to the direct link with the camera of your mobile device\* and also use the functions in this way.

\* may require a suitable app





**www.stauff.com**

With the STAUFF Digital Platform available at [www.stauff.com](http://www.stauff.com), commercial customers and users of STAUFF products can not only inform themselves in all detail about the 50000 components typically available from stock, but also directly purchase these online without complex registration.

General information about the companies of STAUFF Group, latest business and product news as well as complete global contact details also be available.



**www.stauff.com/cad**

Immediate access to and free download of 3D models and 2D drawings for a growing number of STAUFF products





**www.filterinterchange.com**

Online database for the quick and easy identification and interchange of almost all common brands and types of replacement filter elements

**Main Functionalities of the STAUFF Digital Platform:**

-  **Around the clock**  
Check stock availability and pricing for STAUFF products in real time
-  **Cross references**  
Search by article designations of other manufacturers / suppliers
-  **Live chat**  
Get directly in touch with the STAUFF customer service and sales team
-  **CAD database**  
Download 3D models and 2D drawings for STAUFF products

**Advantages as a Registered User of the STAUFF Digital Platform:**

-  **Purchase STAUFF products**  
Taking customer-specific pricing and delivery conditions into account
-  **Ordering w/o searching**  
Quick ordering by entering article number, quantity and requested delivery date
-  **File upload**  
Direct upload of orders with multiple positions in CSV or Excel file format
-  **Notepad function**  
Create project lists to save interesting products for later

Follow STAUFF and keep yourself updated:

-  **Facebook**  
[www.facebook.com/stauffgroup](http://www.facebook.com/stauffgroup)
-  **Twitter**  
[www.twitter.com/stauffgroup](http://www.twitter.com/stauffgroup)
-  **LinkedIn**  
[www.linkedin.com/company/stauff](http://www.linkedin.com/company/stauff)
-  **Youtube**  
[www.youtube.com/stauffgroup](http://www.youtube.com/stauffgroup)



Quick Release Couplings - Overview

Working Pressure bar / PSI	Working Pressure Range											
	1250 / 18130	1000 / 14504	900 / 13054	800 / 11603	700 / 10153	600 / 8702	500 / 7252	400 / 5802	300 / 4351	200 / 2901	100 / 1450	
Series	FF/FH	FU	FH	FO	HP	HU	UX	IA	IA	IB	IB	
Material	Carbon Steel	•	•			•	•	•	•	•	•	
	Stainless Steel			•	•					•		
	Brass											•
Surface Finishing	Zinc-Nickel	•	•			•	•	•	•	•	•	
	Zinc-Plating and Thick-Film-Passivation (Chrome III)	•				•		•				
Standard Seal Material(s) <sup>1</sup>	NBR (Buna-N®)	•	•			•	•	•	•	•	•	
	HNBR											
	FKM (Viton®)			•	•					•		•
	PTFE	•	•	•		•		•				
PU	•	•										
Working Temperature	°C	-25 ... +100	-25 ... +100	-25 ... +200	-25 ... +200	-25 ... +100	-25 ... +100	-30 ... +100	-25 ... +100	-25 ... +200	-25 ... +100	-25 ... +200
	°F	-13 ... +212	-13 ... +212	-13 ... +392	-13 ... +392	-13 ... +212	-13 ... +212	-22 ... +212	-13 ... +212	-13 ... +392	-13 ... +212	-13 ... +392
Valve Design	Flat Face	•	•	•	•							
	Poppet Valve					•	•	•	•	•	•	•
	Ball Valve											
Connection	Push	•	•	•	•	• <sup>2</sup>	• <sup>2</sup>	•				
	Push and actuate Push-Pull Sleeve					•	•					
	Push and actuate Push Sleeve							•	•	•	•	•
Disconnection	Screw											
	Pull					• <sup>2</sup>	• <sup>2</sup>	•				
	Actuate Push-Pull Sleeve					•	•					
Connect Under Pressure <sup>6</sup>	Actuate Push Sleeve	•	•	•	•			•	•	•	•	•
	Screw											
	Male Tip		• <sup>3</sup>					• <sup>3</sup>				
Application	Female Body							• <sup>7</sup>				
	Agricultural and Forestry Machinery					•	•	•	•	•	•	
	Construction Machinery	•	•									
	Industrial Hydraulic	•	•	•					•	•	•	•
	Offshore				•							
Rescue and Tensioning Hydraulics												
ISO Interchange		ISO 16028	ISO 16028	ISO 16028		ISO 7241-1, Series A					ISO 7241-1, Series B	
Page		21	29/30	33	37	41	49	53	57	63	69	75

<sup>1</sup> Alternative seal materials are available on request.  
 Working Pressure depends on the nominal size.  
 Minimum Working Pressure

<sup>2</sup> When mounting the Sleeve in Bulkhead  
<sup>3</sup> Up to max. 250 bar / 3626 PSI  
<sup>4</sup> Up to 33% of the Working Pressure with Tools  
<sup>5</sup> Max. 100 bar / 1450 PSI

<sup>6</sup> Only Residual Pressure  
<sup>7</sup> Female Body up to max. 2,5 bar / 36 PSI,  
 ISO-A Male Tip up to the max. Working Pressure allowed  
<sup>8</sup> Max. 20 bar / 290 PSI Residual Pressure with Tools  
<sup>9</sup> Up to max. 50 bar / 725 PSI with Tools





## Push-to-Connect Couplings - Overview

Description	Characteristics	Series	BG	DN Zoll Inch	DN metric ISO 4397		
Flat Face Coupling	Acc. to ISO 16028  Male Tip Connect Under Pressure	FF-06	1	1/4"	6,3		
		FF-10	2	3/8"	10		
		FF-12	3	1/2"	12,5		
		FF-16	4A	5/8"	16		
		FF-19	4	3/4"	19		
		FF-25	5	1"	25		
		FF-38	6	1 1/2"	31,5		
		FH-51	7	2"	51		
		FU-10	2	3/8"	10		
		FU-12	3	1/2"	12,5		
Flat Face Coupling	Acc. to ISO 16028 Stainless Steel	FH-10	2	3/8"	10		
		FH-12	3	1/2"	12,5		
		FH-19	4	3/4"	19		
Flat Face Coupling	Stainless Steel	FO-06	1	1/4"	6,3		
		FO-10	2	3/8"	10		
		FO-12	3	1/2"	12,5		
		FO-19	4	3/4"	19 (20)		
		FO-25	5	1"	25		
Push-to-Connect Coupling	From HP-10 acc. to ISO 7241-1, Series A Push Pull Type Breakaway Function  Connects with HP-10, Connect Under Pressure	HP-06	1	1/4"	6,3		
		HP-10	2	3/8"	10		
		HP-12	3	1/2"	12,5		
		HP-19	4	3/4"	19 (20)		
		HP-25	6	1"	25		
		HU-12	3	1/2"	12		
Push-to-Connect Coupling	Acc. to ISO 7241-1, Series A Push Pull Type, Breakaway Function	UX-12	3	1/2"	12,5		
Push-to-Connect Coupling	Acc. to ISO 7241-1, Series A	IA-06	1	1/4"	6,3		
		IA-10	2	3/8"	10		
		IA-12	3	1/2"	12,5		
		IA-19	4	3/4"	19 (20)		
		IA-25	6	1"	25		
		IA-31	7	1 1/4"	31,5		
		IA-38	8	1 1/2"	38		
		IA-51	9	2"	51		
Push-to-Connect Coupling	Acc. to ISO 7241-1, Series A Stainless Steel	IA-06	1	1/4"	6,3		
		IA-10	2	3/8"	10		
		IA-12	3	1/2"	12,5		
		IA-19	4	3/4"	19 (20)		
		IA-25	6	1"	25		
		IA-31	7	1 1/4"	31,5		
		IA-38	8	1 1/2"	38		
		IA-51	9	2"	51		
Push-to-Connect Coupling	* Up to DN 25 complys DN 5 acc. to ISO 7241-1, Series B Acc. to ISO 7241-1, Series B	IB-03*	0	1/8"	3,2		
		IB-06	1	1/4"	6,3		
		IB-10	2	3/8"	10		
		IB-12	3	1/2"	12,5		
		IB-19	4	3/4"	19 (20)		
		IB-25	6	1"	25		
		IB-38	8	1 1/2"	38		
		IB-51	9	2"	51		
		Push-to-Connect Coupling	Up to DN 25 Acc. to ISO 7241-1, Series B Brass	IB-06	1	1/4"	6,3
IB-10	2			3/8"	10		
IB-12	3			1/2"	12,5		
IB-19	4			3/4"	19 (20)		
IB-25	6			1"	25		
IB-38	8			1 1/2"	38		
IB-51	9			2"	51		
Push-to-Connect Coupling	Up to DN 25 Acc. to ISO 7241-1, Series B Stainless Steel			IB-06	1	1/4"	6,3
				IB-10	2	3/8"	10
		IB-12	3	1/2"	12,5		
		IB-19	4	3/4"	19 (20)		
		IB-25	6	1"	25		
		IB-38	8	1 1/2"	38		
Push-to-Connect Coupling		ID-06	1	1/4"	6,3		
		ID-10	2	3/8"	10		
		ID-19	4	3/4"	19 (20)		
		ID-25	6	1"	25		
		BP-12	3	1/2"	12,5		
Flat Face Coupling	Acc. to ISO 5676 For Tractor Braking System	HC-06	1	1/4"	6,3		
Flat Face Coupling	Working Pressure 1000 bar / 14504 PSI	HD-06	1	1/4"	6,3		
Flat Face Coupling	Working Pressure 1500 bar / 21756 PSI	HUS-10	2	3/8"	10		
Flat Face Coupling	Nordic Interchange Design	HUS-12	3	1/2"	12,5		
		HUS-19	4	3/4"	19 (20)		
		HUS-25	6	1"	25		



Q <sub>max</sub>	Working Pressure			Bursting Pressure Connected		Female Body		Male Tip		Spillage	
	l/min	US GPM	bar	PSI	bar	PSI	bar	PSI	bar	PSI	ml
40	10.57	400	5802	1500	21756	1220	17695	2000	29008	0,01	.0003
80	21.13	350	5076	1100	15954	1100	15954	1500	21756	0,015	.0005
120	31.70	350	5076	1400	20305	1050	15229	1500	21756	0,02	.0007
150	39.63	350	5076	1600	23206	1200	17405	1200	17405	0,02	.0007
200	52.83	350	5076	1200	17405	1100	15954	1300	18855	0,032	.0011
380	100.39	260	3771	1200	17405	820	11893	1040	15084	0,03	.0010
600	158.50	300	4351	1000	14504	1000	14504	1000	14504	0,155	.0052
1000	264.17	150	2176	650	9427	650	9427	700	10153	0,1	.0034
80	21.13	350	5076	1700	24656			1500	21756	0,015	.0005
120	31.70	350	5076	1500	21756			1400	20305	0,02	.0007
180	47.55	350	5076	1600	23206			1600	23206	0,032	.0011
80	21.13	250	3626	1300	18855	750	10878	1000	14504	0,015	.0005
120	31.70	250	3626	1300	18855	750	10878	1000	14504	0,02	.0007
180	47.55	250	3626	1300	18855	750	10878	1000	14504	0,032	.0011
20	5.28	350	5076	2150	31183	1700	24656	1970	28572	0,01	.0003
45	11.89	350	5076	2000	29008	1300	18855	1400	20305	0,02	.0007
60	15.85	350	5076	2000	29008	1300	18855	1100	15954	0,03	.0010
150	39.63	350	5076	1700	24656	1280	18565	1100	15954	0,06	.0020
240	63.40	350	5076	1450	21031	1150	16679	1000	14504	0,1	.0034
20	5.28	250	3626	1000	14504	1000	14504	1000	14504	0,8	.0271
40	10.57	250	3626	1000	14504	1000	14504	1000	14504	1,2	.0406
100	26.42	250	3626	1000	14504	1000	14504	1000	14504	1,7	.0575
120	31.70	250	3626	1000	14504	1000	14504	1000	14504	8	.2705
160	42.27	250	3626	800	11603	1000	14504	800	11603	12	.4058
90	23.78	250	3626	1100	15954	1500	21756	1000	14504	2,7	.0913
100	26.42	250	3626	1000	14604	1000	14504	1000	14504	1,7	.0575
17	4.49	350	5076	1400	20305	1700	24656	1500	21756	0,5	.0169
46	12.15	275	3989	1500	21756	1500	21756	1400	20305	1,9	.0642
90	23.78	275	3989	1200	17405	1400	20305	1000	14504	2,7	.0913
190	50.19	200	2901	1000	14504	1500	21756	900	13053	9,3	.3145
280	73.97	200	2901	1000	14504	1000	14504	1300	18855	16	.5410
480	126.80	200	2901							30	10.144
757	199.98	130	1885	820	11893	800	11603	800	11603	54	18.260
1000	264.17	130	1885							120	40.577
17	4.49	450	6527	2900	42061	2900	42061	3200	46412	0,5	.0169
46	12.15	300	4351	1300	18855	1250	18130	1250	18130	1,9	.0642
90	23.78	300	4351	1350	19580	1200	17405	1200	17405	2,7	.0913
190	50.19	250	3626	1100	15954	1000	14504	800	11603	9,3	.3145
280	73.97	200	2901	850	12328	650	9427	600	8702	19	.6425
480	126.80	100	1450	400	5802	400	5802	400	5802	30	10.144
700	184.92	80	1160	320	4641	320	4641	320	4641	54	18.260
1000	264.17	60	870	250	3626	250	3626	250	3626	120	40.577
9	2.38	500	7252	2700	39160			2400	34809	0,5	.0169
24	6.34	250	3626	1000	14504	1800	26107	1100	15954	1	.0338
46	12.15	250	3626	1300	18855	1400	20305	1400	20305	2,4	.0812
90	23.78	250	3626	1100	15954	1400	20305	1100	15954	3,9	.1319
220	58.12	220	3191	1000	14504	900	13053	1000	14504	11	.3720
260	68.68	200	2901							19	.6425
757	199.98									95	32.123
1000	264.17									170	57.484
24	6.34	200	2901							1	.0338
46	12.15	200	2901							2,4	.0812
90	23.78	180	2611	1000	14504			720	10443	3,9	.1319
220	58.12	130	1885							11	.3720
260	68.68	130	1885	600	8702			550	7977	19	.6425
757	199.98	60	870							95	32.123
1000	264.17	50	725							170	57.484
24	6.34	350	5076	1600	23206	1500	21756	1700	24656	1	.0338
46	12.15	300	4351	2100	30458	1100	15954	1100	15954	2,4	.0812
90	23.78	300	4351	1500	21756	1400	20305	1500	21756	3,9	.1319
220	58.12	220	3191	1000	14504	900	13053	1000	14504	11	.3720
260	68.68	200	2901	850	12328	650	9427	600	8702	19	.6425
757	199.98	80	1160	250	3626	250	3626	250	3626	95	32.123
1000	264.17	60	870	200	2901	200	2901	200	2901	170	57.484
24	6.34	350	5076							1	.0338
46	12.15	350	5076	1500	21756	1700	24656	1500	21756	2,4	.0812
190	50.19	250	3626	1100	15954	1200	17405	1000	14504	8,6	.2908
250	66.04	250	3626	1000	14504	1100	15954	1200	17405	13	.4396
70	18.49	150	2176	930	13489	620	8992	900	13053	0,05	.0017
6	1.59	1000	14504	2500	36260	2500	36260	2500	36260	0,008	.0003
6	1.59	1500	21756	3500	50763	3500	50763	3500	50763	0,008	.0003
		350	5076	1500	21756	1450	21031	1500	21756		
		315	4569	1520	22046	1200	17405	1300	18855		
		300	4351	1250	18130	1200	17405	1250	181230		
		260	3771	1100	15954	1000	14504	1100	15954		



## Screw-to-Connect Couplings • Overview

Description	Characteristics	Series	BG	DN Zoll Inch	DN metric ISO 4397
Screw-to-Connect Coupling	Acc. to ISO 14541 (BG 1-6)	HS-06 ("...-HX")	1	1/4"	6,3
		HS-10	2	3/8"	10
		HS-12	3	1/2"	12,5
		HS-19	4	3/4"	19
		HS-25	6	1"	25
		HS-25-...-HX	6	1"	25
Screw-to-Connect Coupling	Acc. to ISO 14541 (BG 1-6) Stainless Steel	HS-38	8	1 1/2"	38
		HS-06	1	1/4"	6,3
		HS-10	2	3/8"	10
		HS-12	3	1/2"	12,5
		HS-19	4	3/4"	19 (20)
		HS-25	6	1"	25
Screw-to-Connect Coupling	For Hammer Application	PS-25	08	1 1/4"	25
Flat Face Coupling	Pipeline Coupling	RH-10	2	3/8"	10
		RH-12	3	1/2"	12,5
		RH-16	4	5/8"	16
		RH-19	6	3/4"	19
		RH-25	8	1"	25
Flat Face Coupling	Male Tip Connect Under Pressure	FT-10	2	3/8"	10
		FT-12	3	1/2"	12,5
		FT-16	4A	5/8"	16
		FT-19	4	3/4"	19
		FT-25	5	1"	25
		FT-31	6	1 1/4"	31,5
Screw-to-Connect Coupling		HR-10	2	3/8"	10
		HR-12	3	1/2"	12,5
		HR-19	4	3/4"	19 (20)
		HR-25	6	1"	25
		HR-31	8	1 1/4"	31,5
		HR-38	10	1 1/2"	38
Screw-to-Connect Coupling		HH-10	2	3/8"	10
		HH-12	3	1/2"	12,5
		HH-19	4	3/4"	19 (20)
		HH-25	6	1"	25
		HH-31	8	1 1/4"	31,5
		HH-38	10	1 1/2"	38
		HH-51	12	2"	51
Screw-to-Connect Coupling	Stainless Steel	HH-10	2	3/8"	10
		HH-12	3	1/2"	12,5
		HH-19	4	3/4"	19 (20)
		HH-25	6	1"	25
		HH-31	8	1 1/4"	31,5
		HH-38	10	1 1/2"	38
		HH-51	12	2"	51
Screw-to-Connect Coupling	Acc. to ISO 14540	HI-06	1	1/4"	6,3
		HI-10	2	3/8"	10
		HIB-06	1	1/4"	6,3
		HIB-10	2	3/8"	10
		HT-19	4	3/4"	19 (20)
Screw-to-Connect Coupling	Wing Style	HT-25	6	1"	25
		HM-19	4	3/4"	19 (20)
Screw-to-Connect Coupling	Wing Style Brass and Carbon Steel	HM-25	6	1"	25
		HM-31	8	1 1/4"	31,5
		HM-38	10	1 1/2"	38
Screw-to-Connect Coupling	Wing Style	HV-19	4	3/4"	19 (20)
		HV-25	6	1"	25
		HV-31	8	1 1/4"	31,5
		HV-38	10	1 1/2"	38
		HV-51	12	2"	51

\* short term possible





Q <sub>max</sub>	Working Pressure			Bursting Pressure		Female Body		Male Tip		Spillage	
	l/min	US GPM	bar	PSI	bar	PSI	bar	PSI	bar	PSI	ml
20	5.28	450	6527	1800	26107	1400	20305	1400	20305	0,8	.0271
40	10.57	450	6527	1600	23206	1750	25382	1550	22481	1,3	.0440
80	21.13	400	5802	1400	20305	1200	17405	1200	17405	3,1	.1048
120	31.70	400	5802	1500	21756	1600	23206	1200	17405	5,6	.1894
160	42.27	300	4351	1180	17114	1500	21756	1100	15954	12,3	.4159
160	42.27	350	5076	1180	17114	1500	21756	1100	15954	12,3	.4159
220	58.12	350	5076	1800	26107	1600	23206	1200	17405	52,3	17.685
17	4.49	300	4351	1200	17405	1200	17405	1200	17405	0,8	.0271
30	7.93	250	3626	1500	21756	1400	20305	1000	14504	1,9	.0642
80	21.13	250	3626	1800	26107	1800	26107	1100	15954	2,7	.0913
106	28.00	150	2176	1700	24656	700	10153	600	8702	9,3	.3145
189	49.93	150	2176	1200	17405	600	8702	600	8702	16	.5410
350	92.46	100	1450	400	5802	400	5802	400	5802	30	10.144
600 (1000)*	158.50	380	5511	1520	22046	1520	22046	1520	22046	27	.9130
40	10.57	420	6092	1300	18855	1350	19580	1450	210301	0,1	.0034
70	18.49	420	6092	1260	18275	1260	18275	1260	18275	0,16	.0054
105	27.74	420	6092	1260	18275	1260	18275	1260	18275	1,02	.0344
200	52.83	420	6092	1300	18855	1400	20305	1200	17405	0,86	.0291
500	132.09	420	6092	1150	16679	1100	15954	900	13053	2,84	.0960
80	21.13	550	7977	1400	20305	1100	15954	1400	20305	0,04	.0014
120	31.70	550	7977	1400	20305	1000	14504	1400	20305	0,025	.0008
140	36.98	550	7977	1400	20305	1000	14504	1600	23206		
180	47.55	500	7252	1400	20305	1050	15229	1400	20305	0,018	.0006
260	68.68	470	6817	1300	18855	1000	14504	1300	18855	0,06	.0020
600	158.50	400	5802	1100	15954	1100	15954	1100	15954		
50	13.21	610	8847	2450	35534	2450	35534	2600	37710	2	.0676
85	22.45	470	6817	1900	27557	2100	30458	1650	23931	3	.1014
120	31.70	310	4496	1250	18130	1500	21756	1250	18130	10	.3381
280	73.97	300	4351	1300	18855	1600	23206	1100	15954	16	.5410
460	121.52	300	4351	1300	18855	1300	18855	1200	17405	30	10.144
700	184.92	270	3916	1100	15954	1500	21756	950	13779	54	18.260
18	4.76	650	9427	3000	43511	3000	43511	3000	43511	1,9	.0642
23	6.08	600	8702	2200	31908	2700	39160	2500	36260	2,7	.0913
45	11.89	500	7252	2100	30458	2600	37710	2400	34809	9,3	.3145
106	28.00	460	6672	2000	29008	2600	37710	2300	33359	16	.5410
189	49.93	360	5221	1500	21756	1500	21756	1500	21756	30	10.144
300	79.25	360	5221							54	18.260
757	199.98	210	3046							120	40.577
18	4.76	650	9427	2600	37730	2000	29008	2300	33359	1,9	.0642
23	6.08	600	8702	2500	36260	2700	39160	2100	30458	2,7	.0913
45	11.89	500	7252	2400	34809	1700	24656	2100	30458	9,3	.3145
106	28.00	460	6672	1500	21756	1900	27557	1600	23206	16	.5410
189	49.93	360	5221	1000	14504	1000	14504	1000	14504	30	10.144
300	79.25	360	5221	900	13053	900	13053	900	13053	54	18.260
757	199.98	210	3046	500	7252	500	7252	500	7252	120	40.577
10	2.64	720	10443	2160	31328	2160	31328	2160	31328	0,5	.0176
20	5.28	720	10443	2160	31328	2160	31328	2160	31328	1	.0352
10	2.64	720	10443	2160	31328	1440	20885	1440	20885	0,5	.0176
20	5.28	720	10443	2160	31328	1440	20885	1440	20885	1	.0352
240	63.40	350	5076	1300	18855	1000	14504	1000	14504	10	.3381
320	84.54	300	4351	1000	14504	1000	14504	1000	14504	15	.5072
220	58.12	210	3046	1160	16824	580	8412	460	6672	0,15	.0051
260	68.68	210	3046	880	12763	720	10443	370	5366	0,4	.0135
400	105.67	190	2756	520	7542	570	8267	430	6237	0,65	.0220
600	158.50	170	2466	500	7252	350	5076	430	6237	0,85	.0287
190	50.19	350	5076	1500	21756	750	10878	1400	20305	8	.2705
280	73.97	350	5076	1600	23206	900	13053	1500	21756	16	.5410
480	126.80	350	5076	1300	18855	850	12328	1600	23206	31	10.482
700	184.92	350	5076	1200	17405	600	8702	900	13053	64	21.641
1000	264.17	350	5076	1100	15954	500	7252	600	8702	141	47.678



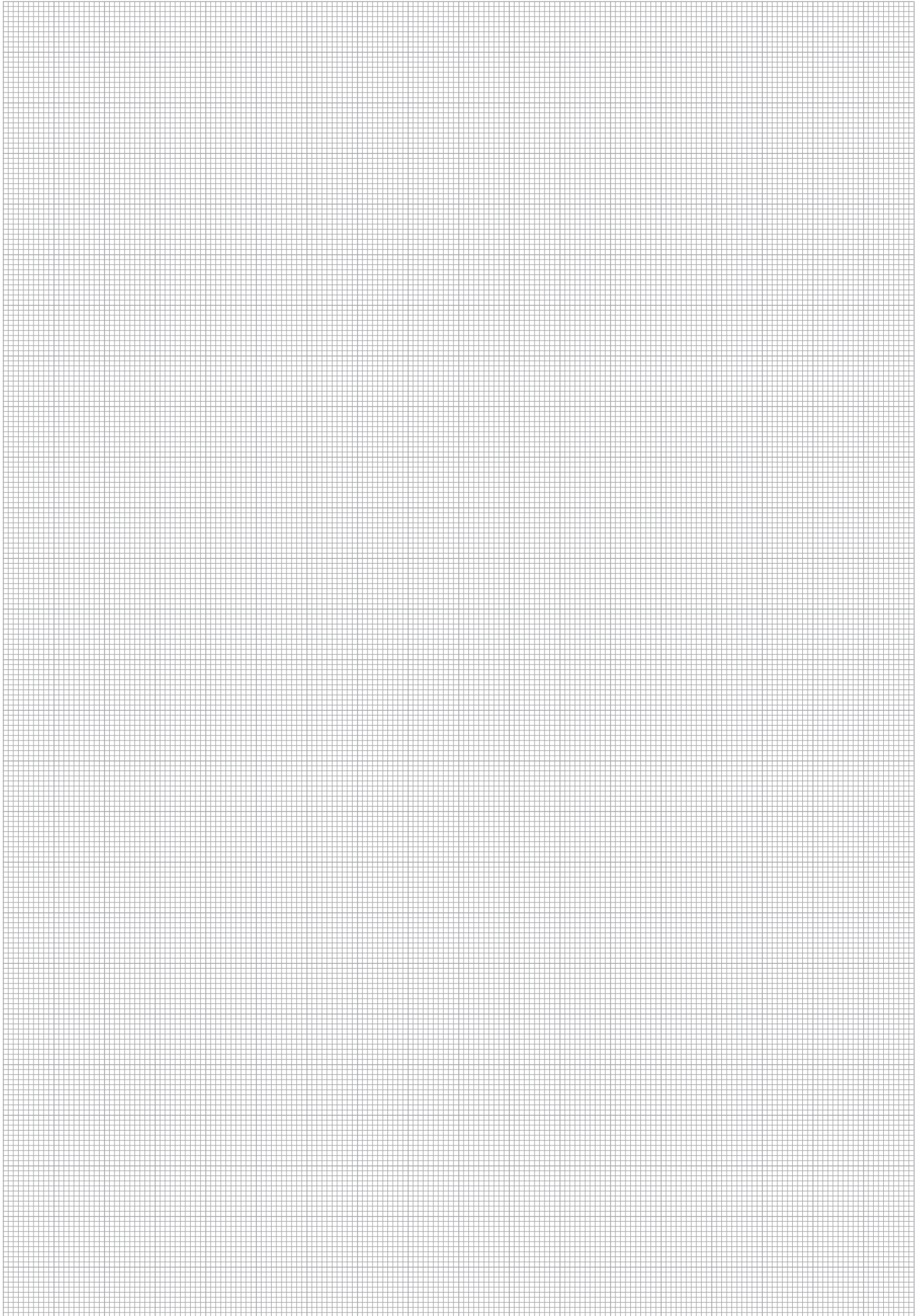

Structure of the Ordering Codes

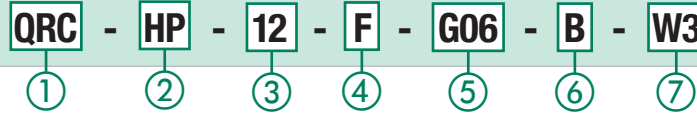

① Quick Release Coupling (QRC)

② Coupling Series				
Push-to-Connect Couplings	FF/FH	Flat Face Coupling acc. to ISO 16028	Push-to-Connect Couplings	HUS
	FU	Flat Face Coupling acc. to ISO 16028, Connect Under Pressure	Multi Couplings	MK
	FH	Flat Face Coupling acc. to ISO 16028, Stainless Steel		HS
	FO	Flat Face Coupling, Stainless Steel		HS
	HP	ISO 7241-1, Series A, Push-Pull		PS
	UX	ISO 7241-1, Series A, Push-Pull, Connect Under Pressure		RH
	IA	ISO 7241-1, Series A		FT
	IA	ISO 7241-1, Series A, Stainless Steel	Screw-to-Connect Couplings	HR
	IB	ISO 7241-1, Series B		HH
	IB	ISO 7241-1, Series B, Brass		HH
	IB	ISO 7241-1, Series B, Stainless Steel		HI
	ID	Push-to-Connect Coupling		HT
	BP	ISO 5676		HM
	HC	Flat Face Coupling		HV
	HD	Flat Face Coupling		

③ Coupling Size																		
STAUFF	ISO 4397	Size	Flange		Metric Ports						Imperial Ports							
			ISO 6162-1	ISO 6261-2	DIN EN ISO 8434-1		EN ISO 6149		EN ISO 9974		ISO 1179 BSP		SAE J514	SAE J1453	SAE J1926-1	ANSI B 1.20.1		
Nominal Size	DN	Inch	350 bar (3000 PSI)	420 bar (6000 PSI)	Light series	Heavy series	Light series	Heavy series	Light series	Heavy series	Light series	Heavy series	Light series	Heavy series	UN / UNF	UN / UNF	UN / UNF	NPT / NPTF
03	3,2	1/8					M8x1	M10x1										
04	4				M12x1,5-6	M14x1,5-6	M10x1	M12x1,5					G 1/8					1/8-27
05	5	3/16				M16x1,5-8												
06	6,3	1/4			M14x1,5-8	M18x1,5-10	M12x5	M14x1,5	M14x1,5	M16x1,5			G 1/4		1/2-20	1 1/16-16		1/4-18
08	8	5/16			M16x1,5-10	M20x1,5-12	M16x1,5		M16x1,5	M18x1,5			G 3/8		9/16-18		9/16-18	
10	10	3/8			M18x1,5-12	M22x1,5-14	M18x1,8	M18x1,5	M18x1,5	M20x1,5			G 3/8		3/4-16	1 3/16-16	3/4-16	3/8-18
12	12,5	1/2	13 (1/2")	13 (1/2")	M22x1,5-15	M24x1,5-16	M22x1,5	M22x1,5	M22x1,5	M22x1,5			G 1/2	G 1/2	7/8-14	1-14	7/8-14	1/2-14
16	16	5/8			M26x1,5-18	M30x2-20	M27x2	M30x2		M27x2			G 3/4	G 3/4	1 1/16-12	1 3/16-12	1 1/16-12	
19	19	3/4	19 (3/4")	19 (3/4")	M30x2-20	M36x2-25	M30x2	M33x2	M26x1,5	M33x2			G 3/4	G 1	1 5/16-12	1 7/16-12	1 5/16-12	3/4-14
25	25	1	25 (1")	25 (1")	M36x2-25	M42x2-30	M33x2	M42x2	M33x2	M42x2			G 1	G 1 1/4	1 5/8-12	1 11/16-12	1 5/8-12	1-11,5
31	31,5	1 1/4	32 (1 1/4")	32 (1 1/4")	M45x2-35	M52x2-38	M42x2	M48x2	M42x2	M48x2			G 1 1/4	G 1 1/2	1 7/8-12	2-12	1 7/8-12	1 1/4-11,5
38	38	1 1/2	38 (1 1/2")	38 (1 1/2")	M52x2-42		M48x2	M60x2					G 1 1/2	G 2	2 1/2-12			1 1/2-11,5
51	51	2	51 (2")	51 (2")											3-12			2-11,5
63	63	2 1/2	64 (2 1/2")	64 (2 1/2")											3 1/2-12			

④ Component of Coupling				⑤ Type of Connection			
CC	Complete Coupling	BF	Dust Cover Body with flip-lid	Gxx	BSP Female thread ISO 1179	F6xx	Flange head 420 bar (6000 PSI), ISO 6262-2
F	Female Body with Valve	HM	Male Tip holder (parking station for Male Tip)	Bxx	BSP Male thread ISO 1179	F3xx	Flange head 350 bar (3000 PSI), ISO 6162-1
FD	Female Body with Dust Plug / Cap	BH	Breakaway holder	NFxx	NPTF Female thread ANSI B 1.20.3	UxxM	UNF Male ORB thread SAE J1926-1, ISO 11926
FF	Female Body with fixed Dust Cover flap lid	FSK	Female Body Sealing Kit	Uxx	UNF Female thread SAE J1926-1, ISO 11926	Cxx	Counter Flange Plate 420 bar (6000 PSI), ISO 6162-2
M	Male Tip with Valve	MSK	Male Tip Sealing Kit	MxxM	Metric Male thread ISO 6149	F6xxM/U/H	
MW	Male Tip without Valve	FP	Fixed part	Mxx	Metric Female thread ISO 6149		Flange 420 bar (6000 PSI), with metric thread / UNC tread / Through hole
MD	Male Tip with Dust Cap / Plug	MP	Mobile part	xxL	Metric Male thread with 24° cone Light series, ISO 8434-1		
DF	Dust Cap/ Plug for Female Body	LV	Lock Valve	xxN	Metric Male thread with 24° cone Light series, ISO 8434-1, Bulkhead	C6xxM/U/H	
DM	Dust Cap/ Plug for Male Tip	SP	Spare parts	xxS	Metric Male thread with 24° cone Heavy series, ISO 8434-1		Counter Flange 420 bar (6000 PSI), with metric thread / UNC tread / Through hole
SF	Slip-on flap lid	FW	Female Body without Valve	xxT	Metric Male thread with 24° cone Heavy series, ISO 8434-1, Bulkhead		

⑥ Sealing Material	
B	NBR (Buna-N®)
PT	PTFE (Teflon)
V	FKM (Viton®)
E	EPDM (Ethylen-Propylen Dien-Kautschuk)
PU	Polyurethan
BT	NBR (Buna-N®) + PTFE (Teflon)
VT	FKM (Viton®) + PTFE (Teflon)
BP	NBR (Buna-N®) + PU (Polyurethan)
BV	NBR (Buna-N®) + FKM (Viton®)
VP	FKM (Viton®) + PU (Polyurethan)
S1	NBR (Buna-N®) + PU (Polyurethan) + PTFE (Teflon)
S2	NBR (Buna-N®) + PU (Polyurethan) + PTFE (Teflon) + FKM (Viton®)
HB	High emperature NBR
HV	High temperature NBR + FKM (Viton®)
S3	High temperature NBR + FKM (Viton®) + PTFE (Teflon)
S4	NBR (Buna-N®) + FKM (Viton®) + PTFE (Teflon)

⑦ Surface / Material	
W3	Steel, zinc-nickel plated
W4	Stainless Steel V2A
W5	Stainless Steel V4A
W48	Steel, zinc plated (with Chrome VI, A3C)
W66	Steel chromium VI-free zinc plated plus thick-layer-passivation (contents CrIII)
W69	Brass
W89	Aluminium exloxtated
W126	Aluminium exloxtated and Stainless Steel V2A
W138	Steel, zinc-nickel plated and zinc (with Chrome VI) plated
W139	Brass and Plastic
W162	Brass and Steel chromium VI-free zinc plated plus thick-layer-passivation (contents CrIII)
K	Plastic





**Series FF/ FH/ FU ▪ Carbon Steel**

Series FF/FH/FU ▪ Overview	22	Series FF-38 ▪ BG 6 ▪ Nominal Size 31,5	29
Series FF-06 ▪ BG 1 ▪ Nominal Size 6,3	23	Series FH/FU 51 ▪ BG 7 ▪ Nominal Size 50	29
Series FF-10 ▪ BG 2 ▪ Nominal Size 10	24	Series FU-10 ▪ BG 2 ▪ Nominal Size 10 Connect Under Pressure	30
Series FF-12 ▪ BG 3 ▪ Nominal Size 12,5	25	Series FU-12 ▪ BG 3 ▪ Nominal Size 12,5 Connect Under Pressure	30
Series FF-16 ▪ BG 4A ▪ Nominal Size 16	26	Series FU-19 ▪ BG 4 ▪ Nominal Size 19 Connect Under Pressure	30
Series FF-19 ▪ BG 4 ▪ Nominal Size 19	27	Series FF/FH/FU ▪ Dust Protection	31
Series FF-25 ▪ BG 5 ▪ Nominal Size 25	28		

**FF/FU**  
**FH**



Series FF/ FH/ FU • Carbon Steel

Material	Carbon Steel
Surface Finishing	Zinc-Nickel, Zinc-Plating and Thick-Film-Passivation (Chrome III) only FF/FU 51
Standard Seal Material(s)	NBR (Buna-N®), PTFE, PU <sup>2</sup>
Working Temperature	-25° C ... +100° C / -13° F ... +212° F
Valve Design	Flat Face
Connection	Push
Disconnection	Actuate Push Sleeve
Connect Under Pressure	not allowed, (Male Tip Series FU up to the max. Working Pressure allowed)
Application	Construction Machinery, Industrial Hydraulic
ISO Interchange	ISO 16028



<sup>2</sup>Alternative seal materials are available on request.

Technical Data

Series	BG	DN Zoll	DN metric ISO 4397	Q <sub>max</sub>		Working Pressure*		Bursting Pressure Connected		Female Body		Male Tip		Spillage	
				l/min	US GPM	bar	PSI	bar	PSI	bar	PSI	bar	PSI	ml	fl oz
FF-06	1	1/4"	6,3	40	10.57	400	5802	1500	21756	1220	17695	2000	29008	0,01	.0003
FF-10	2	3/8"	10	80	21.13	350	5076	1100	15954	1100	15954	1500	21756	0,015	.0005
FF-12	3	1/2"	12,5	120	31.70	350	5076	1400	20305	1050	15229	1500	21756	0,02	.0007
FF-16	4A	5/8"	16	150	39.63	350	5076	1600	23206	1200	17405	1200	17405	0,02	.0007
FF-19	4	3/4"	19	200	52.83	350	5076	1200	17405	1100	15954	1300	18855	0,032	.0011
FF-25	5	1"	25	380	100.39	260	3771	1200	17405	820	11893	1040	15084	0,03	.0010
FF-38	6	1 1/2"	38	600	158.50	300	4351	1000	14504	1000	14504	1000	14504	0,155	.0052
FH-51	7	2"	51	1000	264.17	150	2176	650	9427	650	9427	700	10153	0,1	.0034
FU-10	2	3/8"	10	80	21.13	350	5076	1700	24656			1500	21756	0,015	.0005
FU-12	3	1/2"	12,5	120	31.70	350	5076	1500	21756			1400	20305	0,02	.0007
FU-19	4	3/4"	19	180	47.55	350	5076	1600	23206			1600	23206	0,032	.0011

The indicated pressure ratings only apply to the coupling itself and depend on the connection type.

Flow Characteristics

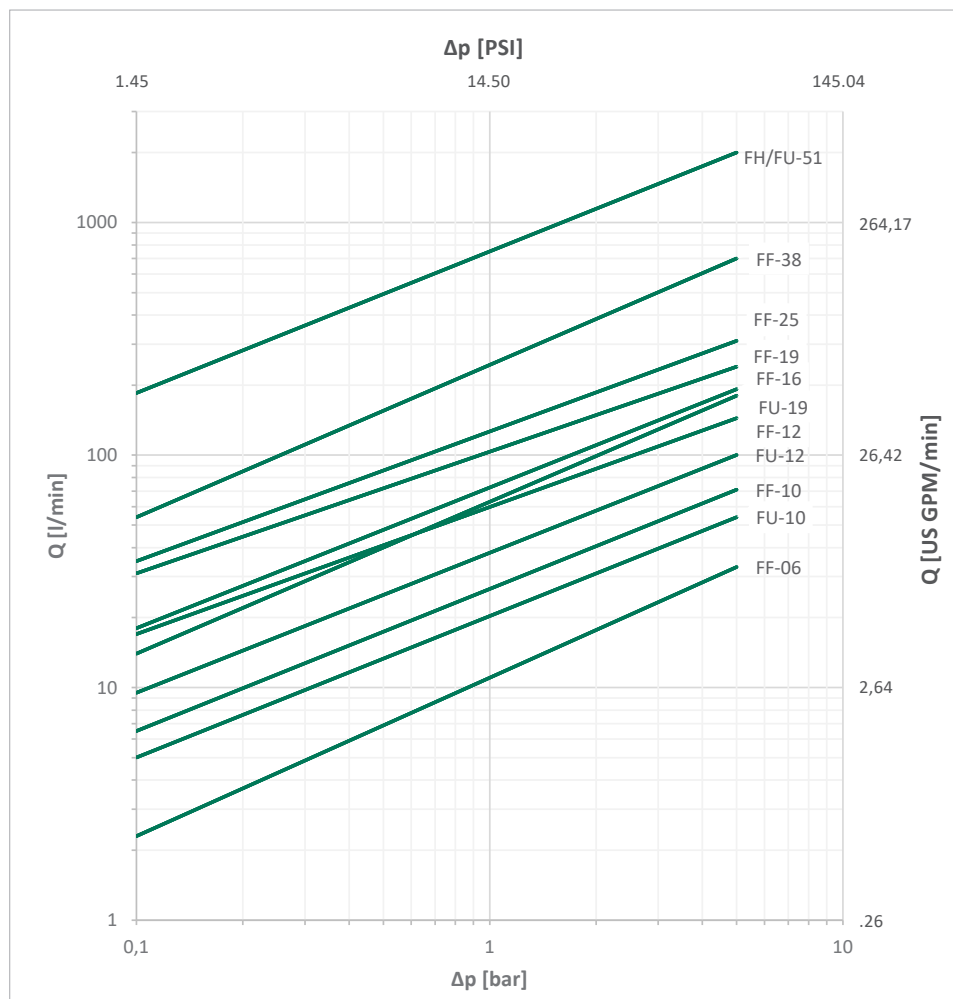

Please note: Unless otherwise stated, all flow characteristics have been determined with hydraulic oil with a kinematic viscosity of 28,8 - 35,2 mm<sup>2</sup>/s (28,8 - 35,2 cSt) and are only valid for components with non-reducing connections.



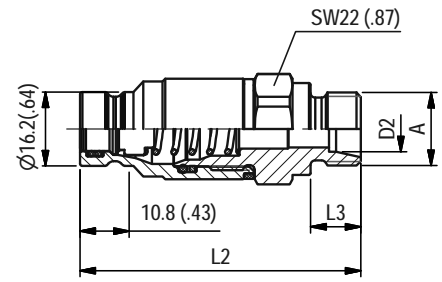
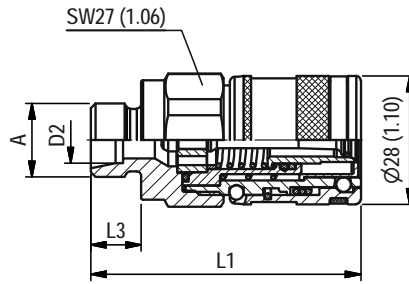

SW: Width across flats. All dimensions in mm (inch).

**FF/FU**  
**FH**
**Series FF-06 ▪ BG 1 ▪ Nominal Size 6,3**

Port A	Dimensions ( <sup>mm</sup> / <sub>in</sub> )					Female Body Ordering Codes	Weight ( <sup>kg</sup> / <sub>lbs</sub> ) ca. per 100	Male Tip Ordering Codes	Weight ( <sup>kg</sup> / <sub>lbs</sub> ) ca. per 100
	ØD2	L1	L2	L3	L4				
<b>Female Thread according to DIN 3852 - ISO 1179-1 - ANSI B 1.20.3 - SAE J1926-1 - ISO 11926-1</b>									
	G 1/4"		55 2.17	54 2.13		12 .47	QRC-FF-06-F-G04-BT-W3 21,20 46.74	QRC-FF-06-M-G04-S1-W3 10,20 22.49	
	NPTF 1/4"-18		55 2.17	54 2.13			QRC-FF-06-F-NF04-BT-W3 22,10 48.72	QRC-FF-06-M-NF04-S1-W3 10,60 23.37	
	UNF 9/16"-18		55 2.17	52 2.05		12,8 .50	QRC-FF-06-F-U06-BT-W3 21,30 46.96	QRC-FF-06-M-U06-S1-W3 10,30 22.71	
<b>Male Thread with 24° Conical Bore - Shape W according to DIN 3861</b>									
	M14x1,5	8L	57 2.24	60 2.36	10 .39		QRC-FF-06-F-08L-BT-W3 18 39.68	QRC-FF-06-M-08L-S1-W3 10,20 22.49	
	M16x1,5	10L	59 2.32	61 2.40	11 .43		QRC-FF-06-F-10L-BT-W3 18,20 40.12	QRC-FF-06-M-10L-S1-W3 10,60 23.40	
<b>Male Thread with 24° Conical Bore - Bulkhead - Shape W according to DIN 3861</b>									
	M14x1,5	8L	73 2.87	75 2.95	25 .98		QRC-FF-06-F-08LB-BT-W3 19,40 42.77	QRC-FF-06-M-08LB-S1-W3 10,30 22.71	
	M16x1,5	10L	74 2.91	76 2.99	26 1.02		QRC-FF-06-F-10LB-BT-W3 20 44.09	QRC-FF-06-M-10LB-S1-W3 10,90 24.03	

Note: The connection of the two halves of a coupling is achieved depending on the type. It is important to observe the positive engagement of plug-type couplings and the secure tightening of screw-type couplings to the limit stop of the thread. Forced or improper separation will result in malfunction of the coupling.



FF/FU  
FH

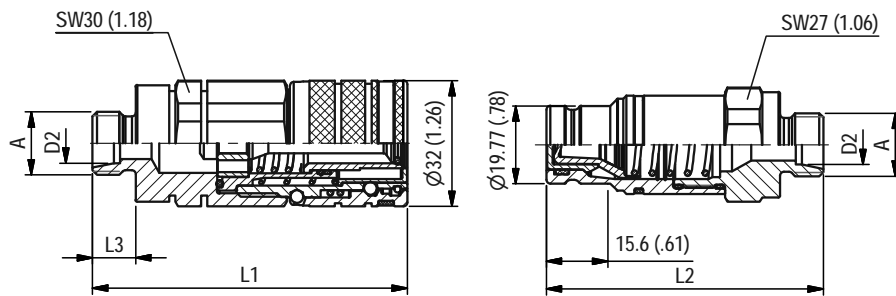

SW: Width across flats. All dimensions in mm (inch).

Series FF-10 ▪ BG 2 ▪ Nominal Size 10

Port A	Dimensions ( <sup>mm</sup> / <sub>in</sub> )					Female Body Ordering Codes	Weight ( <sup>kg</sup> / <sub>lbs</sub> ) ca. per 100	Male Tip Ordering Codes	Weight ( <sup>kg</sup> / <sub>lbs</sub> ) ca. per 100
	ØD2	L1	L2	L3	L4				
<b>Female Thread according to DIN 3852-2 - ISO 6149-1 - ANSI B 1.20.3-SAE J1926-1 - ISO 11926-1</b>									
	G 3/8"	69 2.72	59,9 2.36		14,2 .56	QRC-FF-10-F-G06-BT-W3	28,50 62.83	QRC-FF-10-M-G06-BP-W3	12,70 28
	G 1/2"	69 2.72	64,9 2.56		14,2 .56	QRC-FF-10-F-G08-BT-W3	27 59.52	QRC-FF-10-M-G08-BP-W3	12,10 26.68
	NPTF 3/8"-18	69 2.72	62,9 2.48			QRC-FF-10-F-NF06-BT-W3	28,70 63.27	QRC-FF-10-M-NF06-BP-W3	12,90 28.44
	NPTF 1/2"-14	70 2.76	62,9 2.48			QRC-FF-10-F-NF08-BT-W3	28 61.73	QRC-FF-10-M-NF08-BP-W3	13,70 30.20
	UNF 3/4"-16	69 2.72	63,9 2.52		14,3 .56	QRC-FF-10-F-U08-BT-W3	27,50 60.63	QRC-FF-10-M-U08-BP-W3	13,80 30.42
	<b>Male Thread with 24° Conical Bore - Shape W according to DIN 3861</b>								
	M16x1,5	10L	80 3.15	70,4 2.77	11 .43	QRC-FF-10-F-10L-BT-W3	30 66.14	QRC-FF-10-M-10L-BP-W3	14,70 32.41
	M18x1,5	12L	80 3.15	70,4 2.77	11 .43	QRC-FF-10-F-12L-BT-W3	30 66.14	QRC-FF-10-M-12L-BP-W3	14,70 32.41
	M22x1,5	15L	81 3.19	71,4 2.81	12 .47	QRC-FF-10-F-15L-BT-W3	30,70 67.68	QRC-FF-10-M-15L-BP-W3	15,20 33.51
	M20x1,5	12S	81 3.19	71,4 2.81	12 .47	QRC-FF-10-F-12S-BT-W3	30,90 68.12	QRC-FF-10-M-12S-BP-W3	15,40 33.95
	M24x1,5	16S	83 3.27	73,4 2.89	14 .55	QRC-FF-10-F-16S-BT-W3	31,60 69.67	QRC-FF-10-M-16S-BP-W3	15,90 35.05
<b>Male Thread with 24° Conical Bore - Bulkhead - Shape W according to DIN 3861</b>									
	M16x1,5	10L	87 3.43	85,4 3.36	26 1.02	QRC-FF-10-F-10LB-BT-W3	28,6 62.92	QRC-FF-10-M-10LB-BP-W3	17 36.30
	M18x1,5	12L	87 3.43	85,4 3.36	26 1.02	QRC-FF-10-F-12LB-BT-W3	29 63.58	QRC-FF-10-M-12LB-BP-W3	17 36.96
	M22x1,5	15L	88 3.46	86,4 3.40	27 1.06	QRC-FF-10-F-15LB-BT-W3	31 67.32	QRC-FF-10-M-15LB-BP-W3	18 40.48
	M20x1,5	12S	88 3.46	86,4 3.40	27 1.06	QRC-FF-10-F-12SB-BT-W3	31 67.85	QRC-FF-10-M-12SB-BP-W3	19 40.81
	M24x1,5	16S	89,6 3.53	88,4 3.48	29 1.14	QRC-FF-10-F-16SB-BT-W3	32 71.28	QRC-FF-10-M-16SB-BP-W3	20 43.85

Note: The connection of the two halves of a coupling is achieved depending on the type. It is important to observe the positive engagement of plug-type couplings and the secure tightening of screw-type couplings to the limit stop of the thread. Forced or improper separation will result in malfunction of the coupling.





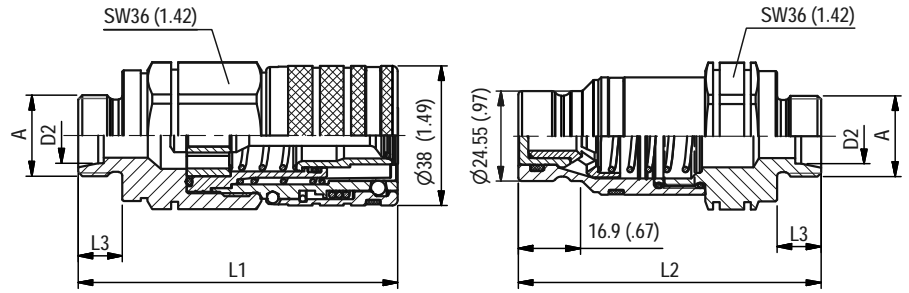

SW: Width across flats. All dimensions in mm (inch).

**Series FF-12 ▪ BG 3 ▪ Nominal Size 12,5**

Port A	Dimensions ( <sup>mm</sup> / <sub>in</sub> )					Female Body Ordering Codes	Weight ( <sup>kg</sup> / <sub>lbs</sub> ) ca. per 100	Male Tip Ordering Codes	Weight ( <sup>kg</sup> / <sub>lbs</sub> ) ca. per 100
	ØD2	L1	L2	L3	L4				
<b>Female Thread according to DIN 3852-2 - ISO 6149-1 - ANSI B 1.20.3- SAE J1926-1 - ISO 11926-1</b>									
	G 1/2"	84 3.31	71 2.80	14 .55		QRC-FF-12-F-G08-BT-W3	50 110.23	QRC-FF-12-M-G08-BP-W3	25,50 56.22
	G 3/4"	84 3.31	72 2.84	18 .71		QRC-FF-12-F-G12-BT-W3	46,60 102.74	QRC-FF-12-M-G12-BP-W3	23,50 51.81
	NPTF 1/2"-14	84 3.31	71 2.80			QRC-FF-12-F-NF08-BT-W3	50,70 111.77	QRC-FF-12-M-NF08-BP-W3	26 57.32
	NPTF 3/4"-14	84 3.31	72 2.84			QRC-FF-12-F-NF12-BT-W3	47,70 105.16	QRC-FF-12-M-NF12-BP-W3	24,10 53.13
	UNF 3/4"-16	84 3.31	72 2.83	14,3 .56		QRC-FF-12-F-U08-BT-W3	50,90 112.22	QRC-FF-12-M-U08-BP-W3	26,30 57.98
	UNF 7/8"-14	84 3.31	72 2.84	16,7 .66		QRC-FF-12-F-U10-BT-W3	49 108.03	QRC-FF-12-M-U10-BP-W3	25,30 55.78
	UN 1" 1/16-12	84 3.31	76 2.99	19 .75		QRC-FF-12-F-U12-BT-W3	45,60 100.53	QRC-FF-12-M-U12-BP-W3	24,50 54.01
	<b>Male Thread with 24° Conical Bore - Shape W according to DIN 3861</b>								
	M18x1,5	12L 3.39	86 3.21	11 .43		QRC-FF-12-F-12L-BT-W3	48,10 106.04	QRC-FF-12-M-12L-BP-W3	27,70 61.07
	M22x1,5	15L 3.43	87 3.25	12 .47		QRC-FF-12-F-15L-BT-W3	48,60 107.14	QRC-FF-12-M-15L-BP-W3	28,40 62.61
	M26x1,5	18L 3.43	87 3.25	12 .47		QRC-FF-12-F-18L-BT-W3	47,60 104.94	QRC-FF-12-M-18L-BP-W3	28,70 63.27
	M30x2	22L 3.50	89 3.33	14 .55		QRC-FF-12-F-22L-BT-W3	48,20 106.26	QRC-FF-12-M-22L-BP-W3	29,10 64.15
	M24x1,5	16S 3.50	89 3.33	14 .55		QRC-FF-12-F-16S-BT-W3	49,50 109.13	QRC-FF-12-M-16S-BP-W3	29,30 64.60
	M30x2	20S 3.58	91 3.41	16 .63		QRC-FF-12-F-20S-BT-W3	50,50 111.33	QRC-FF-12-M-20S-BP-W3	30,70 67.68
	<b>Male Thread with 24° Conical Bore - Bulkhead - Shape W according to DIN 3861</b>								
	M18x1,5	12L 3.58	91 3.70	26 1.02		QRC-FF-12-F-12LB-BT-W3	42,40 93.48	QRC-FF-12-M-12LB-BP-W3	28 61.73
	M22x1,5	15L 3.62	92 3.74	27 1.06		QRC-FF-12-F-15LB-BT-W3	44,20 97.44	QRC-FF-12-M-15LB-BP-W3	29,80 65.70
	M26x1,5	18L 3.62	92 3.74	27 1.06		QRC-FF-12-F-18LB-BT-W3	45,70 100.75	QRC-FF-12-M-18LB-BP-W3	31,30 69.00
	M30x2	22L 3.90	99 4.02	34 1.34		QRC-FF-12-F-22LB-BT-W3	48,70 107.37	QRC-FF-12-M-22LB-BP-W3	34,40 75.84
	M24x1,5	16S 3.70	94 3.82	29 1.14		QRC-FF-12-F-16SB-BT-W3	45,50 100.31	QRC-FF-12-M-16SB-BP-W3	31,60 69.67
	M30x2	20S 3.98	101 4.09	36 1.42		QRC-FF-12-F-20SB-BT-W3	51,50 113.54	QRC-FF-12-M-20SB-BP-W3	37,20 82.01

Note: The connection of the two halves of a coupling is achieved depending on the type. It is important to observe the positive engagement of plug-type couplings and the secure tightening of screw-type couplings to the limit stop of the thread. Forced or improper separation will result in malfunction of the coupling.



FF/FU  
FH

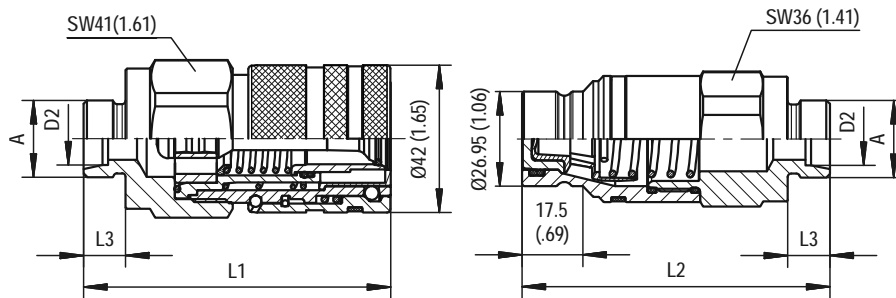

Series FF-16 ▪ BG 4A ▪ Nominal Size 16

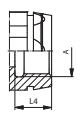
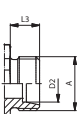
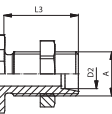
Port A	Dimensions (mm/in)						Female Body	Weight (kg/lbs) ca. per 100	Male Tip	Weight (kg/lbs) ca. per 100
	ØD2	L1	L2	L3	L4	SW1	Ordering Codes		Ordering Codes	
Female Thread according to DIN 3852-2 - ANSI B 1.20.3 - SAE J1926-1 - ISO 11926-1										
	G 3/4"	87 3.43	73 2.87		16 .63	36 1.42	QRC-FF-16-F-G12-BT-W3	64,10 141.32	QRC-FF-16-M-G12-BP-W3	29,20 64.38
	G 1"	89 3.50	80 3.15		18 .71	41 1.61	QRC-FF-16-F-G16-BT-W3	66,90 147.49	QRC-FF-16-M-G16-BP-W3	28,50 62.83
	NPTF 3/4"-14	87 3.43	76 2.99			36 1.42	QRC-FF-16-F-NF12-BT-W3	66,90 147.49	QRC-FF-16-M-NF12-BP-W3	34,00 74.96
	UN 1" 1/16-12	87 3.43	78 3.07		19 .75	36 1.42	QRC-FF-16-F-U12-BT-W3	65,10 143.52	QRC-FF-16-M-U12-BP-W3	33,50 73.86
Male Thread with 24° Conical Bore - Shape W according to DIN 3861										
	M22x1,5	15L	87 3.43	88 3.46	12 .47	36 1.42	QRC-FF-16-F-15L-BT-W3	60,80 134.04	QRC-FF-16-M-15L-BP-W3	36,60 80.69
	M26x1,5	18L	87 3.43	88 3.46	12 .47	36 1.42	QRC-FF-16-F-18L-BT-W3	61,30 135.14	QRC-FF-16-M-18L-BP-W3	36,90 81.35
	M30x2	22L	89 3.50	90 3.54	14 .55	36 1.42	QRC-FF-16-F-22L-BT-W3	61,80 136.25	QRC-FF-16-M-22L-BP-W3	37,30 82.23
	M24x1,5	16S	89 3.50	90 3.54	14 .55	36 1.42	QRC-FF-16-F-16S-BT-W3	61,80 136.25	QRC-FF-16-M-16S-BP-W3	37,40 82.45
	M30x2	20S	91 3.58	92 3.62	16 .63	36 1.42	QRC-FF-16-F-20S-BT-W3	63,30 139.55	QRC-FF-16-M-20S-BP-W3	43,90 96.78
	M36x2	25S	93 3.66	94 3.70	18 .71	41 1.61	QRC-FF-16-F-25S-BT-W3	65,60 144.62	QRC-FF-16-M-25S-BP-W3	47,20 104.06
Male Thread with 24° Conical Bore - Bulkhead - Shape W according to DIN 3861										
	M22x1,5	15L	102 4.02	103 4.06	27 1.06	36 1.42	QRC-FF-16-F-15LB-BT-W3	63,60 140.21	QRC-FF-16-M-15LB-BP-W3	39,50 87.08
	M26x1,5	18L	102 4.02	103 4.06	27 1.06	36 1.42	QRC-FF-16-F-18LB-BT-W3	65,10 143.52	QRC-FF-16-M-18LB-BP-W3	41,10 90.61
	M30x2	22L	109 4.29	110 4.33	34 1.34	36 1.42	QRC-FF-16-F-22LB-BT-W3	68,10 150.14	QRC-FF-16-M-22LB-BP-W3	43,90 96.78
	M24x1,5	16S	104 4.09	105 4.13	29 1.14	36 1.42	QRC-FF-16-F-16SB-BT-W3	65,40 144.18	QRC-FF-16-M-16SB-BP-W3	41,40 91.27
	M30x2	20S	111 4.37	112 4.41	36 1.42	36 1.42	QRC-FF-16-F-20SB-BT-W3	71,00 156.53	QRC-FF-16-M-20SB-BP-W3	46,90 103.40
	M36x2	25S	113 4.45	114 4.49	38 1.50	41 1.61	QRC-FF-16-F-25SB-BT-W3	76,20 167.99	QRC-FF-16-M-25SB-BP-W3	58,20 128.31

Note: The connection of the two halves of a coupling is achieved depending on the type. It is important to observe the positive engagement of plug-type couplings and the secure tightening of screw-type couplings to the limit stop of the thread. Forced or improper separation will result in malfunction of the coupling.



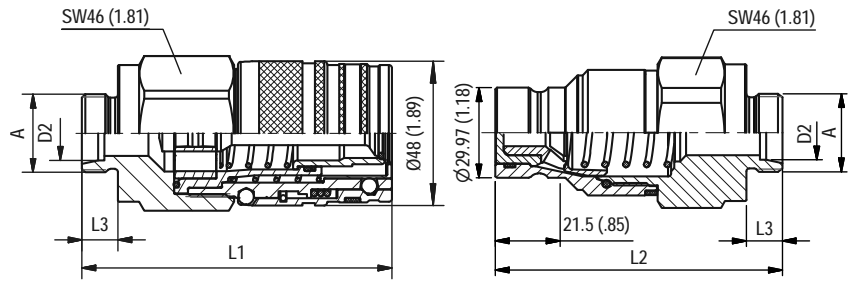

SW: Width across flats. All dimensions in mm (inch).

**Series FF-19 • BG 4 • Nominal Size 19**

Port A	Dimensions ( <sup>mm</sup> / <sub>in</sub> )					Female Body Ordering Codes	Weight ( <sup>kg</sup> / <sub>lbs</sub> ) ca. per 100	Male Tip Ordering Codes	Weight ( <sup>kg</sup> / <sub>lbs</sub> ) ca. per 100
	ØD2	L1	L2	L3	L4				
<b>Female Thread according to DIN 3852-2 - ISO 6149-1 - ANSI B 1.20.3-3-1926-1 - ISO 11926-1</b>									
	G 3/4"	99 3.89	84 3.31		16 .63	<b>QRC-FF-19-F-G12-BT-W3</b>	92,90 204.81	<b>QRC-FF-19-M-G12-BP-W3</b>	53,10 117.07
	G 1"	99 3.89	84 3.31		18 .71	<b>QRC-FF-19-F-G16-BT-W3</b>	87,50 192.90	<b>QRC-FF-19-M-G16-BP-W3</b>	47,40 104.50
	NPTF 3/4"-14	99 3.90	84 3.31			<b>QRC-FF-19-F-NF12-BT-W3</b>	94,40 208.12	<b>QRC-FF-19-M-NF12-BP-W3</b>	54,40 119.93
	NPTF 1"-11 1/2	99 3.90	84 3.31			<b>QRC-FF-19-F-NF16-BT-W3</b>	90,50 199.52	<b>QRC-FF-19-M-NF16-BP-W3</b>	50,50 111.33
	UN 1" 1/16-12	99 3.90	84 3.31		19 .75	<b>QRC-FF-19-F-U12-BT-W3</b>	93,10 205.25	<b>QRC-FF-19-M-U12-BP-W3</b>	53 116.85
	UN 1" 5/16-12	99 3.90	84 3.31		19 .75	<b>QRC-FF-19-F-U16-BT-W3</b>	89,30 196.87	<b>QRC-FF-19-M-U16-BP-W3</b>	47,90 105.60
	<b>Male Thread with 24° Conical Bore - Shape W according to DIN 3861</b>								
	M26x1,5	18L 4.06	103 3.76	96 4.7	12	<b>QRC-FF-19-F-18L-BT-W3</b>	91,10 200.84	<b>QRC-FF-19-M-18L-BP-W3</b>	60,70 133.82
	M30x2	22L 4.14	105 3.84	98 4.55	14	<b>QRC-FF-19-F-22L-BT-W3</b>	91,10 200.84	<b>QRC-FF-19-M-22L-BP-W3</b>	59,80 131.84
	M36x2	28L 4.14	105 3.84	98 4.55	14	<b>QRC-FF-19-F-28L-BT-W3</b>	90,30 199.08	<b>QRC-FF-19-M-28L-BP-W3</b>	58,10 128.09
	M30x2	20S 4.22	107 3.92	100 4.63	16 .63	<b>QRC-FF-19-F-20S-BT-W3</b>	93,10 205.25	<b>QRC-FF-19-M-20S-BP-W3</b>	62,50 137.79
	M36x2	25S 4.30	109 4.00	102 4.71	18	<b>QRC-FF-19-F-25S-BT-W3</b>	94,70 208.78	<b>QRC-FF-19-M-25S-BP-W3</b>	63,20 139.33
	M42x2	30S 4.38	111 4.07	104 4.79	20	<b>QRC-FF-19-F-30S-BT-W3</b>	96,10 211.86	<b>QRC-FF-19-M-30S-BP-W3</b>	63,70 140.43
<b>Male Thread with 24° Conical Bore - Bulkhead - Shape W according to DIN 3861</b>									
	M26x1,5	18L 4.93	125 4.63	118 1.34	34	<b>QRC-FF-19-F-18LB-BT-W3</b>	97,20 214.29	<b>QRC-FF-19-M-18LB-BP-W3</b>	66,80 147.27
	M30x2	22L 4.93	125 4.63	118 1.34	34	<b>QRC-FF-19-F-22LB-BT-W3</b>	97,70 215.39	<b>QRC-FF-19-M-22LB-BP-W3</b>	66,50 146.61
	M36x2	28L 4.93	125 4.63	118 1.34	34	<b>QRC-FF-19-F-28LB-BT-W3</b>	99,20 218.70	<b>QRC-FF-19-M-28LB-BP-W3</b>	67 147.71
	M30x2	20S 5.09	129 4.70	120 1.42	36	<b>QRC-FF-19-F-20SB-BT-W3</b>	101,80 224.43	<b>QRC-FF-19-M-20SB-BP-W3</b>	70,40 155.21
	M36x2	25S 5.09	129 4.86	124 1.50	38	<b>QRC-FF-19-F-25SB-BT-W3</b>	105,76 233.16	<b>QRC-FF-19-M-25SB-BP-W3</b>	74,30 163.80
	M42x2	30S 5.17	131 4.86	124 1.50	38	<b>QRC-FF-19-F-30SB-BT-W3</b>	110,10 242.73	<b>QRC-FF-19-M-30SB-BP-W3</b>	77,80 171.52

Note: The connection of the two halves of a coupling is achieved depending on the type. It is important to observe the positive engagement of plug-type couplings and the secure tightening of screw-type couplings to the limit stop of the thread. Forced or improper separation will result in malfunction of the coupling.



FF/FU  
FH

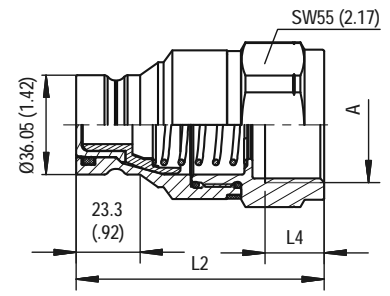
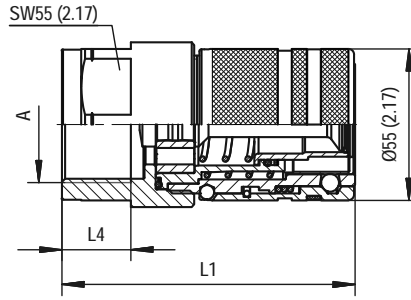

SW: Width across flats. All dimensions in mm (inch).

Series FF-25 ▪ BG 5 ▪ Nominal Size 25

Port A	Dimensions ( <sup>mm</sup> / <sub>in</sub> )					Female Body	Weight ( <sup>kg</sup> / <sub>lbs</sub> ) ca. per 100	Male Tip	Weight ( <sup>kg</sup> / <sub>lbs</sub> ) ca. per 100
	ØD2	L1	L2	L3	L4	Ordering Codes		Ordering Codes	
Female Thread according to DIN 3852-2 - ANSI B 1.20.3 - SAE J1926-1 - ISO 11926-1									
	G 1"	106	90		18	QRC-FF-25-F-G16-BT-W3	141,50	QRC-FF-25-M-G16-BP-W3	81,50
		4.17	3.54		.71		311.95		179.68
	G 1" 1/4	106	90		20	QRC-FF-25-F-G20-BT-W3	130,10	QRC-FF-25-M-G20-BP-W3	71,40
		4.17	3.54		.79		286.82		157.41
	G 1" 1/2	106	95,6		22	QRC-FF-25-F-G24-BT-W3	120,50	QRC-FF-25-M-G24-BP-W3	83,00
		4.17	3.76		.87		265.66		182.98
	NPTF 1" 11 1/2	106	90			QRC-FF-25-F-NF16-BT-W3	143,00	QRC-FF-25-M-NF16-BP-W3	83,00
		4.17	3.54				315.26		182.98
NPTF 1" 1/4-11 1/2	106	90			QRC-FF-25-F-NF20-BT-W3	133,70	QRC-FF-25-M-NF20-BP-W3	73,60	
	4.17	3.54				294.76		162.26	
UN 1" 5/16 - 12	106	90		19	QRC-FF-25-F-U16-BT-W3	140,50	QRC-FF-25-M-U16-BP-W3	80,80	
	4.17	3.54		.75		309.75		178.13	
UN 1" 5/8 - 12	106	90		19	QRC-FF-25-F-U20-BT-W3	132,10	QRC-FF-25-M-U20-BP-W3	72,00	
	4.17	3.54		.75		291.23		158.73	

Note: The connection of the two halves of a coupling is achieved depending on the type. It is important to observe the positive engagement of plug-type couplings and the secure tightening of screw-type couplings to the limit stop of the thread. Forced or improper separation will result in malfunction of the coupling.



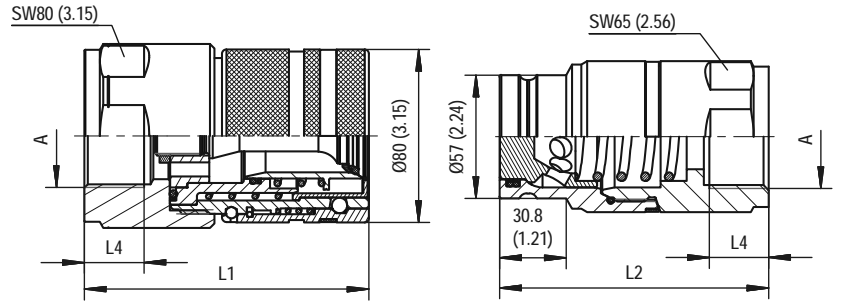

SW: Width across flats. All dimensions in mm (inch).

**Series FF-38 • BG 6 • Nominal Size 38**

Port A	Dimensions (mm/in)					Female Body Ordering Codes	Weight ( <sup>kg</sup> /lbs) ca. per 100	Male Tip Ordering Codes	Weight ( <sup>kg</sup> /lbs) ca. per 100
	ØD2	L1	L2	L3	L4				
Female Thread according to ISO 3852-2 - ANSI B 1.20.3 - SAE J1926-1 - ISO 11926-1									
	G 1 1/4"	131,6 5.18	124,6 4.91		21,5 .85	QRC-FF-38-F-G20-S1-W3	388,40 856.28	QRC-FF-38-M-G20-BT-W3	218,60 481.93
	G 1 1/2"	131,6 5.18	124,6 4.91		23 .89	QRC-FF-38-F-G24-S1-W3	379,10 835.77	QRC-FF-38-M-G24-BT-W3	209,90 462.75
	NPTF 1" 1/4- 11 1/2	131,6 5.18	124,6 4.91			QRC-FF-38-F-NF20-S1-W3	390,50 860.91	QRC-FF-38-M-NF20-BT-W3	221,10 487.44
		131,6 5.18	124,6 4.91			QRC-FF-38-F-NF24-S1-W3	381,20 840.40	QRC-FF-38-M-NF24-BT-W3	216,80 477.96
	UN 1" 5/8-12	131,6 5.18	124,6 4.91		19 .75	QRC-FF-38-F-U20-S1-W3	387,70 854.73	QRC-FF-38-M-U20-BT-W3	218,50 481.71
		131,6 5.18	124,6 4.91		19 .75	QRC-FF-38-F-U24-S1-W3	376,10 829.16	QRC-FF-38-M-U24-BT-W3	210,30 463.63

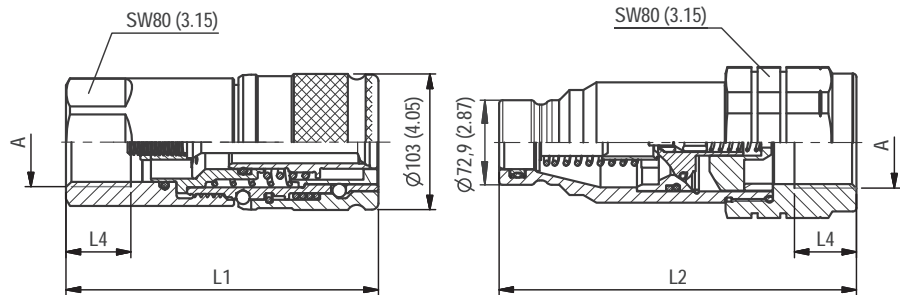

SW: Width across flats. All dimensions in mm (inch).

**Series FH/FU 51 • BG 7 • Nominal Size 51**

Port A	Dimensions (mm/in)					Female Body Ordering Codes	Weight ( <sup>kg</sup> /lbs) ca. per 100	Male Tip Ordering Codes	Weight ( <sup>kg</sup> /lbs) ca. per 100
	ØD2	L1	L2	L3	L4				
Female Thread according to DIN 3852-2-A - ANSI B 1.20.3									
	G 2"	147,4 5.80	173 6.81		24 .94	QRC-FH-51-F-G32-BT-W66	550 1212.54	QRC-FU-51-M-G32-BT-W66	489 1078.06
		NPTF 2" -11 1/2	147,4 5.80	173 6.81			QRC-FH-51-F-NF32-BT-W66	540 1190.50	QRC-FU-51-M-NF32-BT-W66

Note: The connection of the two halves of a coupling is achieved depending on the type. It is important to observe the positive engagement of plug-type couplings and the secure tightening of screw-type couplings to the limit stop of the thread. Forced or improper separation will result in malfunction of the coupling.



FF/FU  
FH

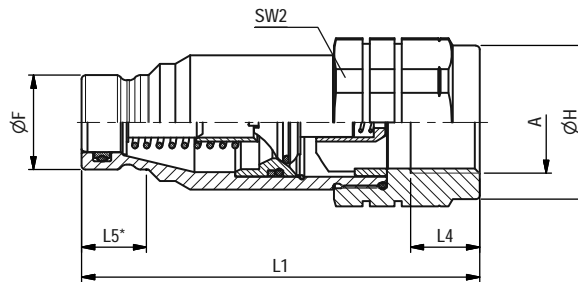

SW: Width across flats. All dimensions in mm (inch). Drawing similar Series FU-12.  
\* Insertion Male Tip

**Series FU-10 • BG 2 • Nominal Size 10 • Connect Under Pressure**

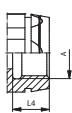
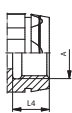
Port A	Dimensions (mm/in)						Male Tip Ordering Codes	Weight (kg/lbs) ca. per 100
	ØF	ØH	L1	L4	L5	SW2		
Female Thread according to DIN 3852-2								
 G 3/8"	19,79	29,3	87	12	15,6	30	QRC-FU-10-M-G06-BT-W3	24,10
	.78	1.17	3.43	.47	.61	1.18		53.13
 G 1/2"	19,79	29,3	90	14	15,6	30	QRC-FU-10-M-G08-BT-W3	24,60
	.78	1.17	3.54	.55	.61	1.18		54.23

**Series FU-12 • BG 3 • Nominal Size 12,5 • Connect Under Pressure**

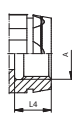
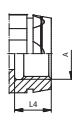
Port A	Dimensions (mm/in)						Male Tip Ordering Codes	Weight (kg/lbs) ca. per 100
	ØF	ØH	L1	L4	L5	SW2		
Female Thread according to DIN 3852-2								
 G 1/2"	24,58	40	98	14	16,9	41	QRC-FU-12-M-G08-BT-W3	49,20
	.97	1.57	3.86	.55	.67	1.61		108.47
 G 3/4"	24,58	40	104	16	16,9	41	QRC-FU-12-M-G12-BT-W3	51,10
	.97	1.57	4.09	.63	.67	1.61		112.66

**Series FU-19 • BG 4 • Nominal Size 19 • Connect Under Pressure**

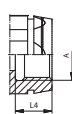
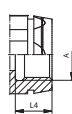
Port A	Dimensions (mm/in)						Male Tip Ordering Codes	Weight (kg/lbs) ca. per 100
	ØF	ØH	L1	L4	L5	SW2		
Female Thread according to DIN 3852-2								
 G 3/4"	30	45,5	114	16	21,5	46	QRC-FU-19-M-G12-BT-W3	82,60
	1.18	1.79	4.49	.63	.85	1.81		182.10
 G 1"	30	45,5	114	18	21,5	46	QRC-FU-19-M-G16-BT-W3	77,90
	1.18	1.79	4.49	.71	.85	1.81		171.74

Note: The connection of the two halves of a coupling is achieved depending on the type. It is important to observe the positive engagement of plug-type couplings and the secure tightening of screw-type couplings to the limit stop of the thread. Forced or improper separation will result in malfunction of the coupling.

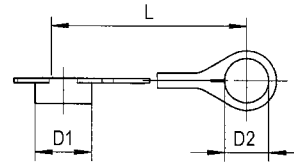
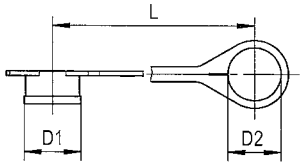

**Series FH/FU/FF • Dust Protection**

**FF/FU**
**FH**

Dimensions (mm/in)			Material	Dust Cap for Male Tip
D1	D2	L		Ordering Codes
28	24	170	Plastic (Colour: Red)	QRC-FF-06-DM-22-K-RD
1.10	.94	6.69		
32	27	115	Plastic (Colour: Red)	QRC-FF-10-DM-27-K-RD
1.26	1.06	4.53		
38	35,5	135	Plastic (Colour: Red)	QRC-FF-12-DM-36-K-RD
1.50	1.40	5.31		
42	30	220	Plastic (Colour: Red)	QRC-FF-16-DM-30-K-RD
1.65	1.18	8.66		
48	45,5	150	Plastic (Colour: Red)	QRC-FF-19-DM-46-K-RD
1.89	1.79	5.91		
46	51	290	Plastic (Colour: Red)	QRC-FF-25-DM-51-K-RD
1.81	2.01	11.42		

Dimensions (mm/in)			Material	Dust Plug for Female Body
D1	D2	L		Ordering Codes
34	24	170	Plastic (Colour: Red)	QRC-FF-06-DF-24-K-RD
1.34	.94	6.69		
38	30	130	Plastic (Colour: Red)	QRC-FF-10-DF-30-K-RD
1.50	1.18	5.12		
45	35,5	140	Plastic (Colour: Red)	QRC-FF-12-DF-36-K-RD
1.77	1.40	5.51		
46	30	225	Plastic (Colour: Red)	QRC-FF-16-DF-30-K-RD
1.81	1.18	8.86		
52	45,5	170	Plastic (Colour: Red)	QRC-FF-19-DF-46-K-RD
2.05	1.79	6.69		
62	51	290	Plastic (Colour: Red)	QRC-FF-25-DF-51-K-RD
2.44	2.01	11.42		

In addition to the standard colours as stated above,  
 plastic dust caps are also available in blue, green, yellow and black.  
 Please use the color codes BU, GN, YE and BK respectively instead of RD.



FF/FU  
FH

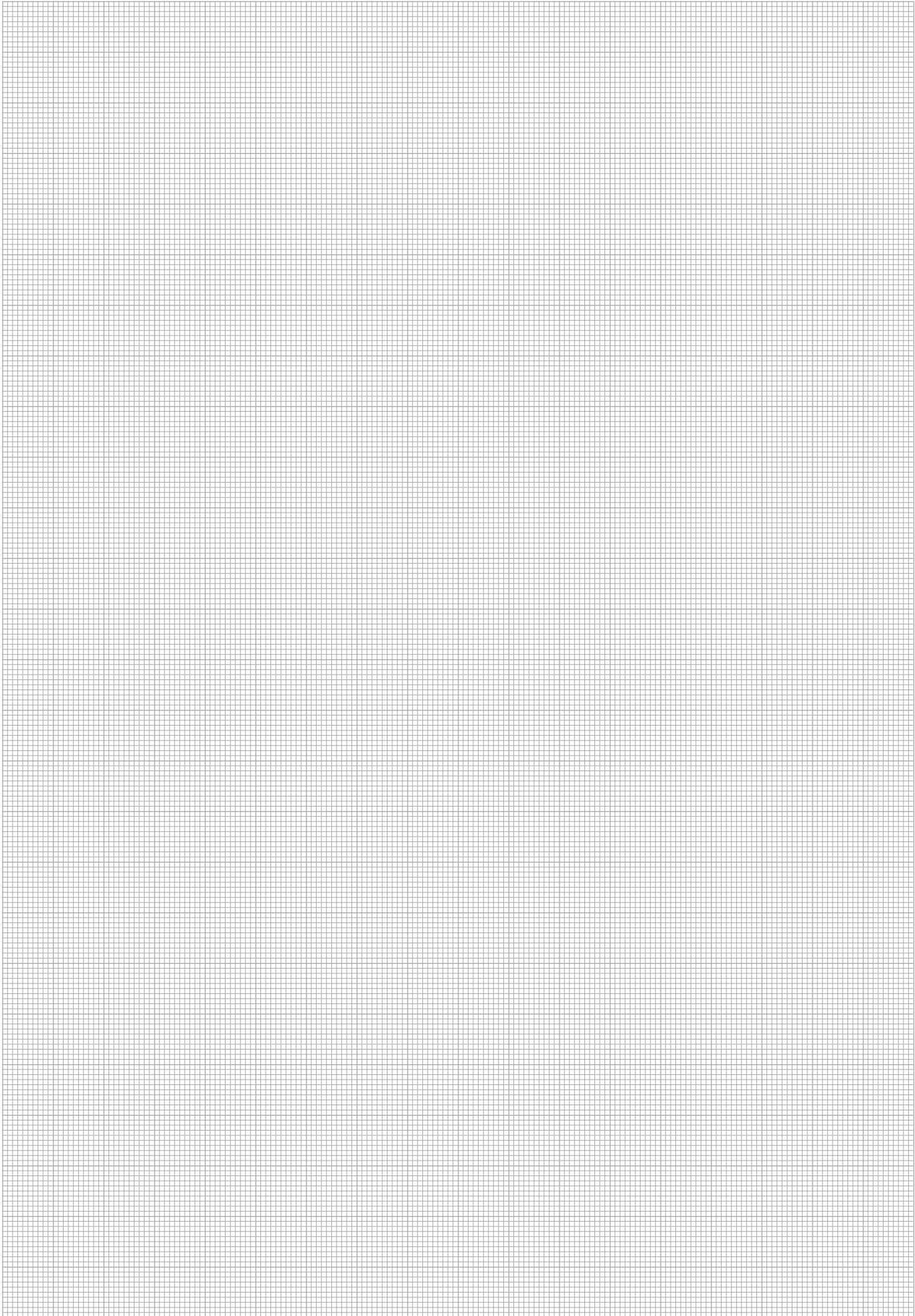



Series FH ▪ Stainless Steel

Series FH ▪ Overview	34
Series FH-10 ▪ BG 2 ▪ Nominal Size 10	35
Series FH-12 ▪ BG 3 ▪ Nominal Size 12,5	35
Series FH-19 ▪ BG 4 ▪ Nominal Size 19	36

FF/FU  
FH



Series FH • Stainless Steel

Material	Stainless Steel V4A (AISI 316L)
Surface Finishing	-
Standard Seal Material(s)	FKM (Viton®), PTFE <sup>2</sup>
Working Temperature	-25° C ... +200° C / -13° F ... +392° F
Valve Design	Flat Face
Connection	Push
Disconnection	Actuate Push Sleeve
Connect Under Pressure	not allowed
Application	Industrial Hydraulic
ISO Interchange	ISO 16028



<sup>2</sup>Alternative seal materials are available on request.

Technical Data

Series	BG	DN Zoll Inch	DN metric ISO 4397	Q <sub>max</sub>		Working Pressure		Bursting Pressure Connected		Female Body		Male Tip		Spillage	
				l/min	US GPM	bar	PSI	bar	PSI	bar	PSI	bar	PSI	ml	fl oz
FH-10	2	3/8"	10	80	21.13	250	3626	1300	18855	750	10878	1000	14504	0,015	.0005
FH-12	3	1/2"	12,5	120	31.70	250	3626	1300	18855	750	10878	1000	14504	0,02	.0007
FH-19	4	3/4"	19	180	47.55	250	3626	1300	18855	750	10878	1000	14504	0,032	.0011

The indicated pressure ratings only apply to the coupling itself and depend on the connection type.

Flow Characteristics

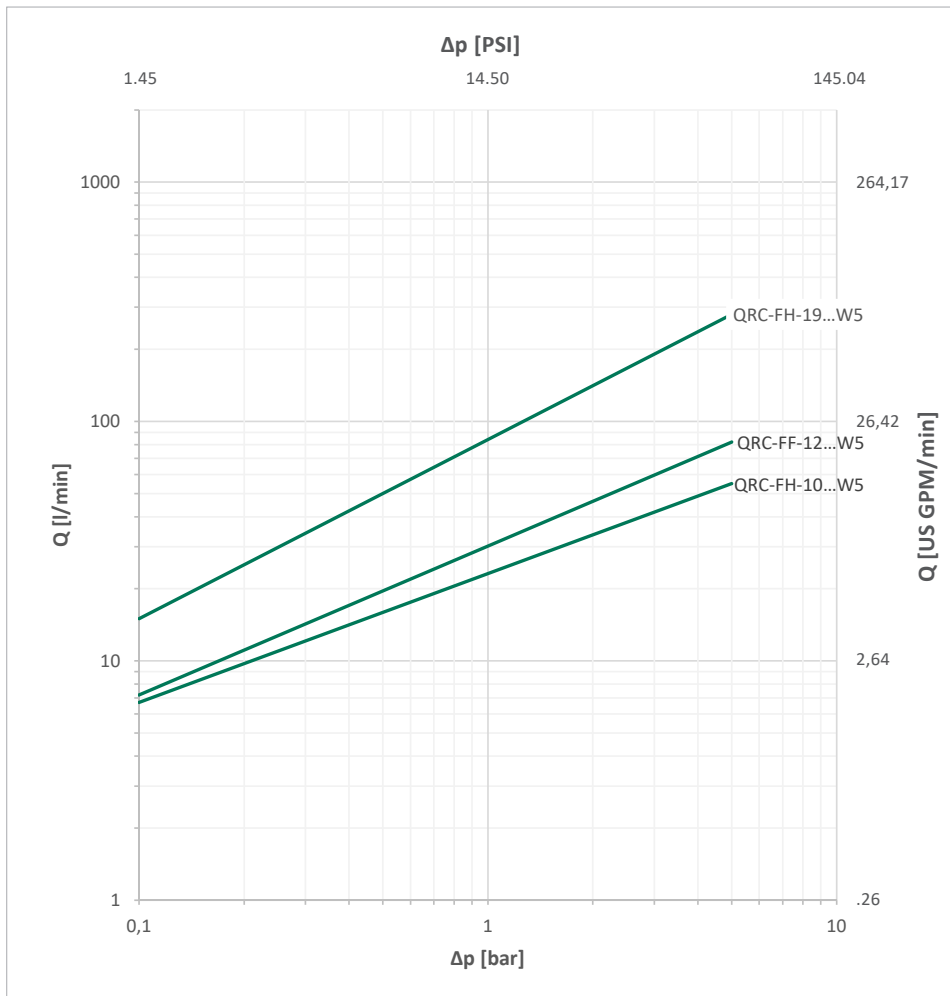

Please note: Unless otherwise stated, all flow characteristics have been determined with hydraulic oil with a kinematic viscosity of 28,8 - 35,2 mm<sup>2</sup>/s (28,8 - 35,2 cSt) and are only valid for components with non-reducing connections.



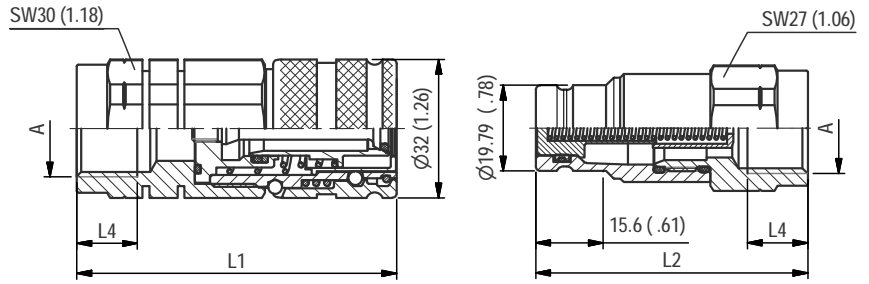

SW: Width across flats. All dimensions in mm (inch).

**Series FH-10 • BG 2 • Nominal Size 10**

Port A	Dimensions (mm/in)					Female Body Ordering Codes	Weight (kg/lbs) ca. per 100	Male Tip Ordering Codes	Weight (kg/lbs) ca. per 100
	ØD2	L1	L2	L3	L4				
<b>Female Thread according to DIN 3852-2 - ISO 9974-1 - ANSI B 1.20.3</b>									
	G 3/8"	68,9	57,8		12,5	QRC-FH-10-F-G06-VT-W5	30	QRC-FH-10-M-G06-VT-W5	15,80
		2.71	2.28		.49		66.14		34.83
	G 1/2"	74	62,9		14	QRC-FH-10-F-G08-VT-W5	30,40	QRC-FH-10-M-G08-VT-W5	15,50
		2.91	2.48		.55		67.02		34.17
	NPTF 1/2"	74	62,9			QRC-FH-10-F-NF08-VT-W5	30,80	QRC-FH-10-M-NF08-VT-W5	15,20
		2.91	2.48				67.90		33.51
<b>Male Thread with 24° Conical Bore - Shape W according to DIN 3861</b>									
	M18x1,5	12L	88,3	79,4	11	QRC-FH-10-F-12L-VT-W5	34,50	QRC-FH-10-M-12L-VT-W5	20,40
			3.48	3.13	.43		76.06		44.97
	M22x1,5	15L		110,9	27	QRC-FH-10-F-15LB-VT-W5		QRC-FH-10-M-15LB-VT-W5	29,80
				4.37	1.06				65.70

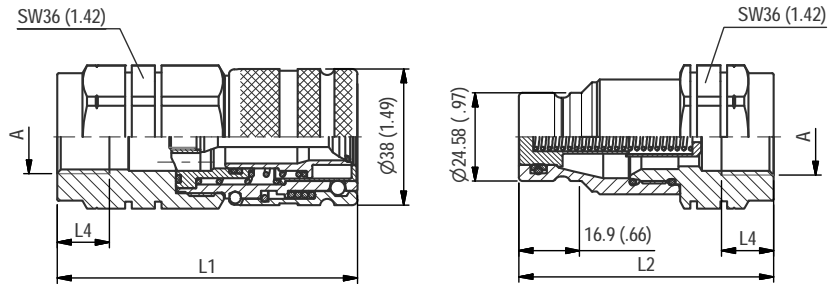

SW: Width across flats. All dimensions in mm (inch).

**Series FH-12 • BG 3 • Nominal Size 12,5**

Port A	Dimensions (mm/in)					Female Body Ordering Codes	Weight (kg/lbs) ca. per 100	Male Tip Ordering Codes	Weight (kg/lbs) ca. per 100
	ØD2	L1	L2	L3	L4				
<b>Female Thread according to DIN 3852-2 - ISO 9974-1 - ANSI B 1.20.3</b>									
	G 1/2"	84	71		14	QRC-FH-12-F-G08-VT-W5	52,50	QRC-FH-12-M-G08-VT-W5	32,60
		3.31	2.80		.55		115.74		71.87
	G 3/4"	84	71		16	QRC-FH-12-F-G12-VT-W5	49,10	QRC-FH-12-M-G12-VT-W5	29,50
		3.31	2.80		.63		108.25		65.04
	NPTF 1/2"	84	71			QRC-FH-12-F-NF08-VT-W5	52,80	QRC-FH-12-M-NF08-VT-W5	33
		3.31	2.80				116.40		72.75
<b>Male Thread with 24° Conical Bore - Shape W according to DIN 3861</b>									
	M18x1,5	12L	103,8	91,1	11	QRC-FH-12-F-12L-VT-W5	60,10	QRC-FH-12-M-12L-VT-W5	40,40
			4.09	3.59	.43		132.50		89.07
	M22x1,5	15L	104,8	92,1	12	QRC-FH-12-F-15L-VT-W5	60,60	QRC-FH-12-M-15L-VT-W5	40,90
			4.13	3.63	1.06		133.60		90.17

Note: The connection of the two halves of a coupling is achieved depending on the type. It is important to observe the positive engagement of plug-type couplings and the secure tightening of screw-type couplings to the limit stop of the thread. Forced or improper separation will result in malfunction of the coupling.



FF/FU  
FH

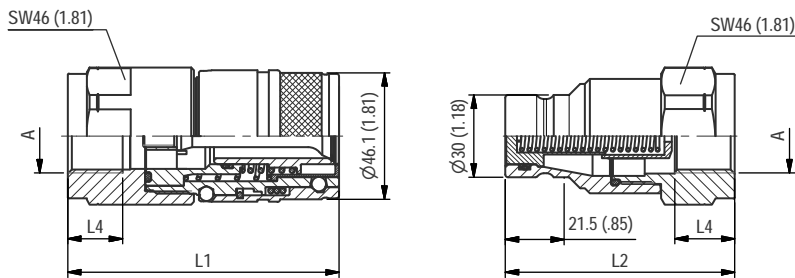

SW: Width across flats. All dimensions in mm (inch).

**Series FH-19 • BG 4 • Nominal Size 19**

Port A	Dimensions (mm/in)					Female Body Ordering Codes	Weight (kg/lbs) ca. per 100	Male Tip Ordering Codes	Weight (kg/lbs) ca. per 100
	ØD2	L1	L2	L3	L4				
<b>Female Thread according to DIN 3852-2 - ISO 9974-1 - ANSI B 1.20.3</b>									
	G 3/4"		99 3.90	84 3.31	16 .63	QRC-FH-19-F-G12-VT-W5	102,90 226.86	QRC-FH-19-M-G12-VT-W5	57 125.66
	G 1"		99 3.90	84 3.31	18 .71	QRC-FH-19-F-G16-VT-W5	97,20 214.29	QRC-FH-19-M-G16-VT-W5	51,10 112.66
	NPTF 1"-11 1/2		99 3.90	84 3.31		QRC-FH-19-F-NF16-VT-W5	100,40 221.34	QRC-FH-19-M-NF16-VT-W5	54,30 119.71
<b>Male Thread with 24° Conical Bore - Shape W according to DIN 3861</b>									
	M30x2	20S	130	114,8	16	QRC-FH-19-F-20S-VT-W5	120	QRC-FH-19-M-20S-VT-W5	74,10
			5.12	4.52	.63		264.55		163.36

Note: The connection of the two halves of a coupling is achieved depending on the type. It is important to observe the positive engagement of plug-type couplings and the secure tightening of screw-type couplings to the limit stop of the thread. Forced or improper separation will result in malfunction of the coupling.



Series F0 ▪ Stainless Steel

Series F0 ▪ Overview	38
Series F0-06 ▪ BG 1 ▪ Nominal Size 6,3	39
Series F0-10 ▪ BG 2 ▪ Nominal Size 10	39
Series F0-12 ▪ BG 3 ▪ Nominal Size 12,5	39
Series F0-19 ▪ BG 4 ▪ Nominal Size 19	39
Series F0-25 ▪ BG 5 ▪ Nominal Size 25	40

F0



### Series FO • Stainless Steel

Material	Stainless Steel V4A (AISI 316)
Surface Finishing	-
Standard Seal Material(s)	FKM (Viton®) <sup>2</sup>
Working Temperature	-25° C ... +200° C / -13° F ... +392° F
Valve Design	Flat Face
Connection	Push
Disconnection	Actuate Push Sleeve
Connect Under Pressure	not allowed
Application	Offshore
ISO Interchange	-



FO

<sup>2</sup> Alternative seal materials are available on request.

### Technical Data

Series	BG	DN Zoll Inch	DN metric ISO 4397	Q <sub>max</sub>		Working Pressure		Bursting Pressure Connected		Female Body		Male Tip		Spillage	
				l/min	US GPM	bar	PSI	bar	PSI	bar	PSI	bar	PSI	ml	fl oz
FO-06	1	1/4"	6,3	20	5.28	350	5076	2150	31183	1700	24656	1970	28572	0,01	.0003
FO-10	2	3/8"	10	45	11.89	350	5076	2000	29008	1300	18855	1400	20305	0,02	.0007
FO-12	3	1/2"	12,5	60	15.85	350	5076	2000	29008	1300	18855	1100	15954	0,03	.0010
FO-19	4	3/4"	19 (20)	150	39.63	350	5076	1700	24656	1280	18565	1100	15954	0,06	.0020
FO-25	5	1"	25	240	63.40	350	5076	1450	21031	1150	16679	1000	14504	0,1	.0034

The indicated pressure ratings only apply to the coupling itself and depend on the connection type.

### Flow Characteristics

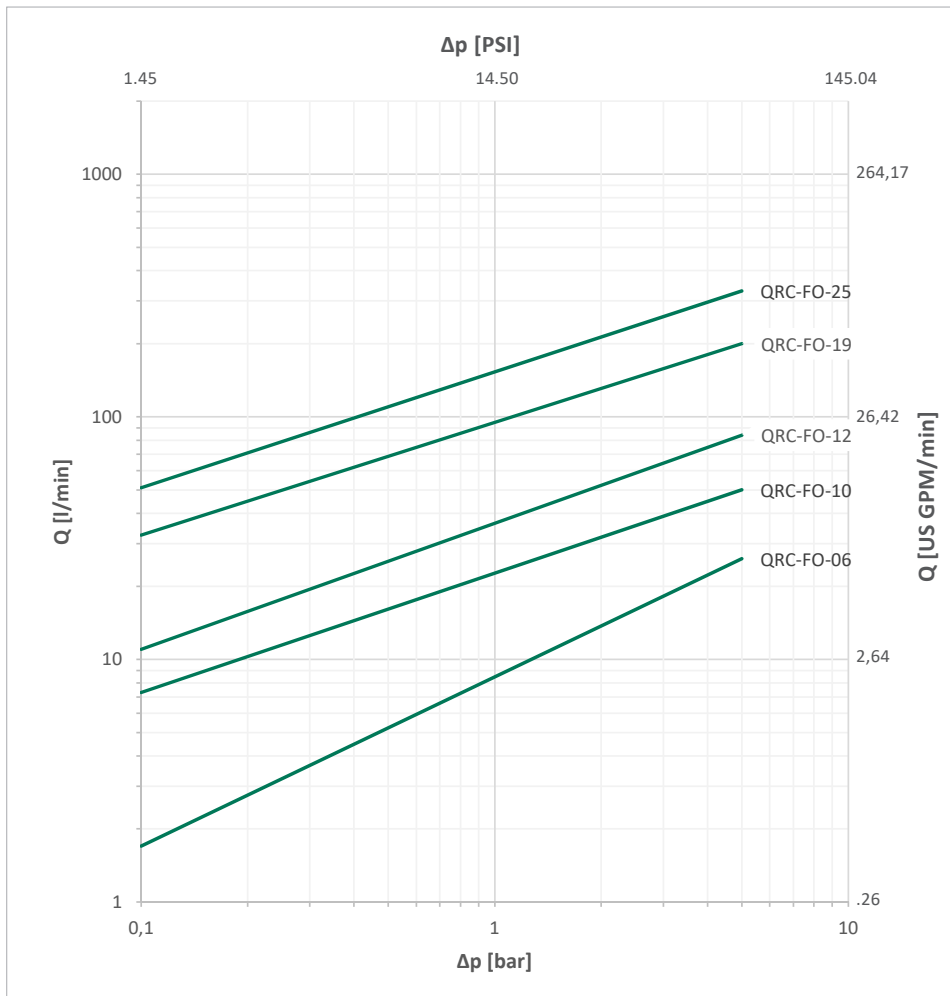

Please note: Unless otherwise stated, all flow characteristics have been determined with hydraulic oil with a kinematic viscosity of 28,8 - 35,2 mm<sup>2</sup>/s (28,8 - 35,2 cSt) and are only valid for components with non-reducing connections.



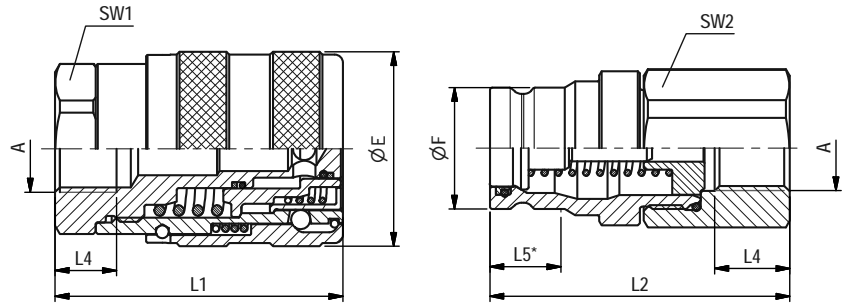

SW: Width across flats. All dimensions in mm (inch). Drawing similar Series FO-12.  
\* Insertion Male Tip

### Series FO-06 ▪ BG 1 ▪ Nominal Size 6,3

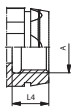
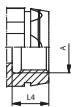
Port A	Dimensions ( <sup>mm</sup> / <sub>in</sub> )								Female Body Ordering Codes	Weight ( <sup>kg</sup> / <sub>lbs</sub> ) ca. per 100	Male Tip Ordering Codes	Weight ( <sup>kg</sup> / <sub>lbs</sub> ) ca. per 100
	ØE	ØF	L1	L2	L4 min	L5	SW1	SW2				
Female Thread according to DIN 3852 - ISO 1179-1 - ANSI B 1.20.3												
 G 1/4"	30	18	52	61,5	12	13,5	24	22	QRC-FO-06-F-G04-VT-W5	17,72	QRC-FO-06-M-G04-VT-W5	12,06
	1.18	.71	2.04	2.42	.47	.53	.94	.87		39.07		26.59
 NPTF 1/4" -18	30	18	52	61,5	12	13,5	24	22	QRC-FO-06-F-NF04-VT-W5	18,00	QRC-FO-06-M-NF04-VT-W5	12,30
	1.18	.71	2.04	2.42	.47	.53	.94	.87		39.68		27.12

### Series FO-10 ▪ BG 2 ▪ Nominal Size 10

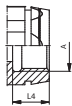
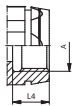
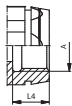
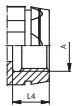
Port A	Dimensions ( <sup>mm</sup> / <sub>in</sub> )								Female Body Ordering Codes	Weight ( <sup>kg</sup> / <sub>lbs</sub> ) ca. per 100	Male Tip Ordering Codes	Weight ( <sup>kg</sup> / <sub>lbs</sub> ) ca. per 100
	ØE	ØF	L1	L2	L4 min	L5	SW1	SW2				
Female Thread according to DIN 3852 - ISO 1179-1 - ANSI B 1.20.3												
 G 3/8"	40	23,7	62	70	14	16,5	30	30	QRC-FO-10-F-G06-VT-W5	39	QRC-FO-10-M-G06-VT-W5	21,70
	1.57	.93	2.44	2.76	.47	.65	1.18	1.18		85.98		47.84
 NPTF 3/8" -18	40	23,7	62	70		16,5	30	30	QRC-FO-10-F-NF06-VT-W5	39	QRC-FO-10-M-NF06-VT-W5	22
	1.57	.93	2.44	2.76		.65	1.18	1.18		85.98		48.50
 G 1/2"	40	23,7	62	69,5	14	16,5	30	30	QRC-FO-10-F-G08-VT-W5	36,90	QRC-FO-10-M-G08-VT-W5	20,10
	1.57	.93	2.44	2.74	.55	.65	1.18	1.18		81.35		44.31
 NPTF 1/2" -14	40	23,7	62	73,5		16,5	30	30	QRC-FO-10-F-NF08-VT-W5	37,10	QRC-FO-10-M-NF08-VT-W5	21,60
	1.57	.93	2.44	2.89		.65	1.18	1.18		81.79		47.62

### Series FO-12 ▪ BG 3 ▪ Nominal Size 12,5

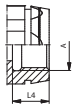
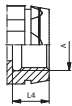
Port A	Dimensions ( <sup>mm</sup> / <sub>in</sub> )								Female Body Ordering Codes	Weight ( <sup>kg</sup> / <sub>lbs</sub> ) ca. per 100	Male Tip Ordering Codes	Weight ( <sup>kg</sup> / <sub>lbs</sub> ) ca. per 100
	ØE	ØF	L1	L2	L4 min	L5	SW1	SW2				
Female Thread according to DIN 3852 - ISO 1179-1 - ANSI B 1.20.3												
 G 1/2"	48	30	71	74	14	17,5	38	36	QRC-FO-12-F-G08-VT-W5	64,20	QRC-FO-12-M-G08-VT-W5	38,18
	1.89	1.18	2.80	2.91	.55	.69	1.49	1.42		141.54		84.17
 NPTF 1/2" -14	48	30	71	74		17,5	38	36	QRC-FO-12-F-NF08-VT-W5	63,90	QRC-FO-12-M-NF08-VT-W5	38,42
	1.89	1.18	2.80	2.91		.69	1.49	1.42		140.88		84.70

### Series FO-19 ▪ BG 4 ▪ Nominal Size 19

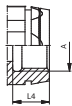
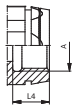
Port A	Dimensions ( <sup>mm</sup> / <sub>in</sub> )								Female Body Ordering Codes	Weight ( <sup>kg</sup> / <sub>lbs</sub> ) ca. per 100	Male Tip Ordering Codes	Weight ( <sup>kg</sup> / <sub>lbs</sub> ) ca. per 100
	ØE	ØF	L1	L2	L4 min	L5	SW1	SW2				
Female Thread according to DIN 3852 - ISO 1179-1 - ANSI B 1.20.3												
 G 3/4"	58	38,6	79	90	16	22	46	41	QRC-FO-19-F-G12-VT-W5	96,16	QRC-FO-19-M-G12-VT-W5	62
	2.28	1.52	3.11	3.54	.63	.87	1.81	1.61		212.00		123.46
 NPTF 3/4" -14	58	38,6	79	90		22	46	41	QRC-FO-19-F-NF12-VT-W5	96,00	QRC-FO-19-M-NF12-VT-W5	56,70
	2.28	1.52	3.11	3.54		.87	1.81	1.61		211.64		125.00

Note: The connection of the two halves of a coupling is achieved depending on the type. It is important to observe the positive engagement of plug-type couplings and the secure tightening of screw-type couplings to the limit stop of the thread. Forced or improper separation will result in malfunction of the coupling.



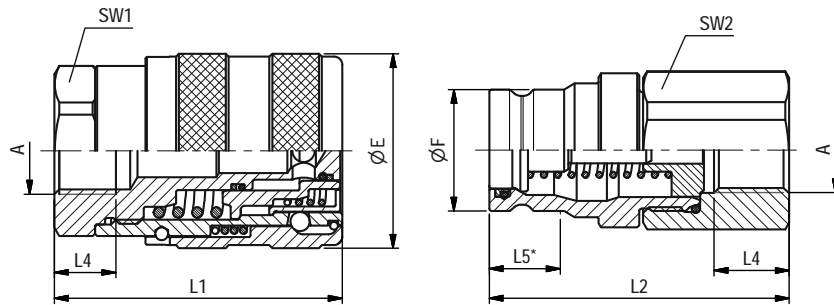

SW: Width across flats. All dimensions in mm (inch). Drawing similar Series FO-12.  
\* Insertion Male Tip

Series FO-25 • BG 5 • Nominal Size 25

Port A	Dimensions (mm/in)									Female Body	Weight ( <sup>kg</sup> /lbs) ca. per 100	Male Tip	Weight ( <sup>kg</sup> /lbs) ca. per 100
	ØE	ØF	L1	L2	L4 min	L5	SW1	SW2	Ordering Codes	Ordering Codes			
Female Thread according to DIN 3852 - ISO 1179-1 - ANSI B 1.20.3													
	G 1"	68	45	88	107	18	23	50	50	QRC-FO-25-F-G16-VT-W5	137	QRC-FO-25-M-G16-VT-W5	82,80
		2.68	1.77	3.46	4.21	.71	.90	1.97	1.97		302.03		182.54
	NPTF 1" -11 1/2	68	45	88	107	18	23	50	50	QRC-FO-25-F-NF16-VT-W5	138,50	QRC-FO-25-M-NF16-VT-W5	84
		2.68	1.77	3.46	4.21	.71	.90	1.97	1.97		305.34		185.19
	G 1 1/4"	68	45	88	107	18	23	50	50	QRC-FO-25-F-G20-VT-W5	127,50	QRC-FO-25-M-G20-VT-W5	86,80
		2.68	1.77	3.46	4.21	.71	.90	1.97	1.97		281.09		191.36
	NPTF 1 1/4" -11 1/2	68	45	88	107	18	23	50	50	QRC-FO-25-F-NF20-VT-W5	128,90	QRC-FO-25-M-NF20-VT-W5	880
		2.68	1.77	3.46	4.21	.71	.90	1.97	1.97		284.18		1936.00

Note: The connection of the two halves of a coupling is achieved depending on the type. It is important to observe the positive engagement of plug-type couplings and the secure tightening of screw-type couplings to the limit stop of the thread. Forced or improper separation will result in malfunction of the coupling.





Series HP ▪ Carbon Steel

Series HP ▪ Overview	42	Series HU-12 ▪ BG 3 ▪ Nominal Size 12,5 Connect Under Pressure	49
Series HP-06 ▪ BG 1 ▪ Nominal Size 6,3	43	Series HP-19 ▪ BG 4 ▪ Nominal Size 19	50
Series HP-10 ▪ BG 2 ▪ Nominal Size 10	44	Series HP-25 ▪ BG 6 ▪ Nominal Size 25	51
Series HP-10A ▪ BG 2 ▪ Nominal Size 10	45	Series HP and Series HU ▪ Dust Protection	52
Series HP-12 ▪ BG 3 ▪ Nominal Size 12,5	46 - 47		
Series ZP-12 ▪ BG 3 ▪ Nominal Size 12,5	48		
Series AP-12 ▪ BG 3 ▪ Nominal Size 12,5	49		

HP/HU



### Series HP ▪ Carbon Steel

Material	Carbon Steel
Surface Finishing	Zinc-Nickel <sup>1</sup> , Zinc-Plating and Thick-Film-Passivation (Chrome III)
Standard Seal Material(s)	NBR (Buna-N®), PTFE <sup>2</sup>
Working Temperature	-25° C ... +100° C / -13° F ... +212° F
Valve Design	Poppet Valve
Connection	Push (When mounting the Sleeve in Bulkhead), Push and actuate Push-Pull Sleeve
Disconnection	Pull (When mounting the Sleeve in Bulkhead), Actuate Push-Pull Sleeve
Connect Under Pressure	not allowed, (Male Tip Series HU up to the max. Working Pressure allowed)
Application	Agricultural and Forestry Machinery
ISO Interchange	ISO 7241-1 A and ISO 5675 (for selected sizes).



HP/HU

<sup>1</sup> Only Nominal Size 12,5  
<sup>2</sup> Alternative seal materials are available on request.

### Technical Data

Series	BG	DN Zoll	DN metric ISO 4397	Q <sub>max</sub>		Working Pressure		Bursting Pressure Connected		Female Body		Male Tip		Spillage	
				l/min	US GPM	bar	PSI	bar	PSI	bar	PSI	bar	PSI	ml	fl oz
HP-06	1	1/4"	6,3	20	5.28	250	3626	1000	14504	1000	14504	1000	14504	0,8	.0271
HP-10	2	3/8"	10	40	10.57	250	3626	1000	14504	1000	14504	1000	14504	1,2	.0406
HP-12	3	1/2"	12,5	100	26.42	250	3626	1000	14504	1000	14504	1000	14504	1,7	.0575
HP-19	4	3/4"	19 (20)	120	31.70	250	3626	1000	14504	1000	14504	1000	14504	8	.2705
HP-25	6	1"	25	160	42.27	250	3626	800	11603	1000	14504	800	11603	12	.4058
HU-12	3	1/2"	12	90	23.78	250	3626	1100	15954	1500	21756	1000	14504	2,7	.0913

The indicated pressure ratings only apply to the coupling itself and depend on the connection type.

### Flow Characteristics

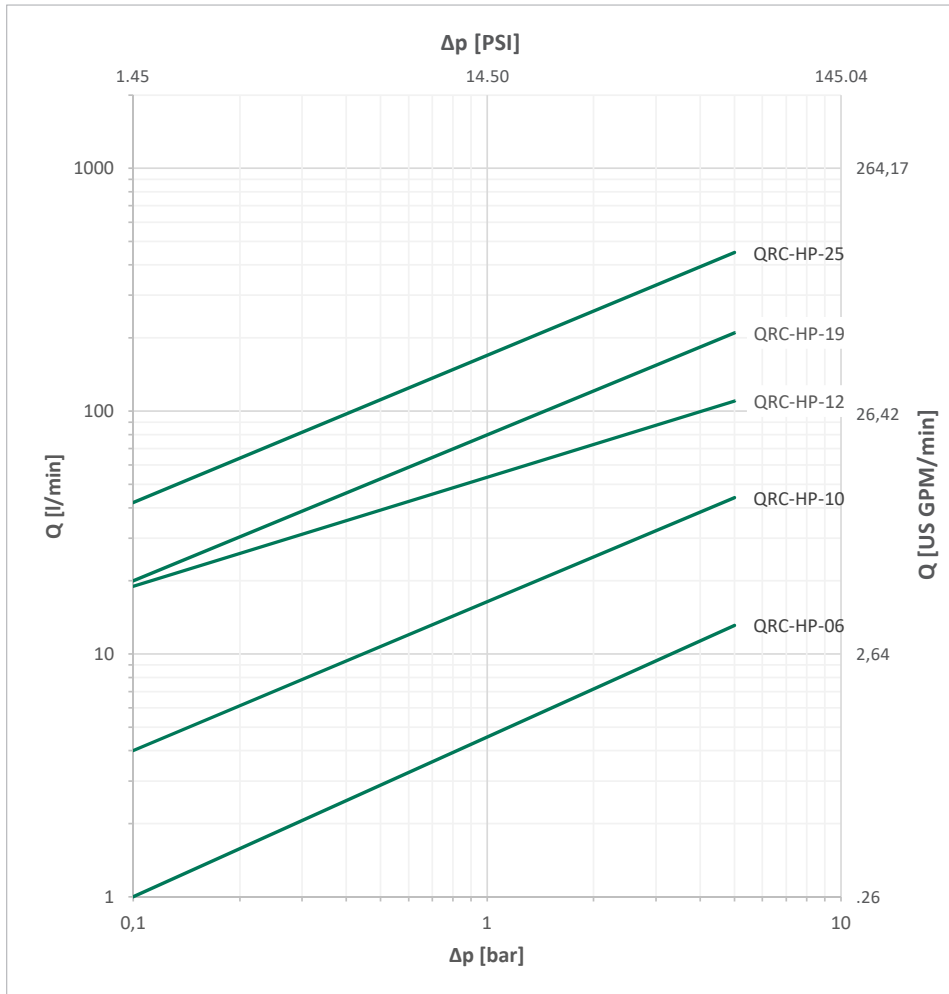

Please note: Unless otherwise stated, all flow characteristics have been determined with hydraulic oil with a kinematic viscosity of 28,8 - 35,2 mm<sup>2</sup>/s (28,8 - 35,2 cSt) and are only valid for components with non-reducing connections.



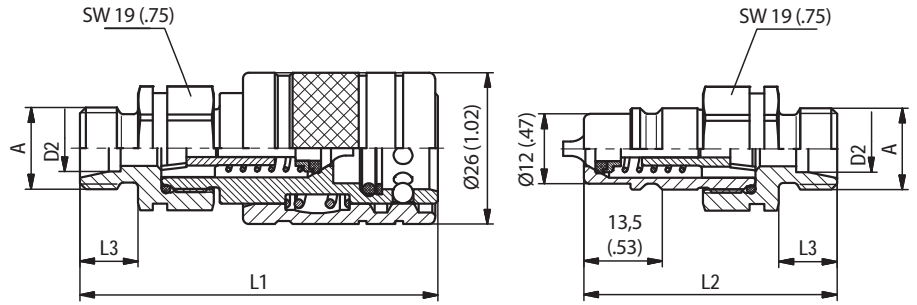

SW: Width across flats. All dimensions in mm (inch).

**Series HP-06 • BG 1 • Nominal Size 6,3**
**HP/HU**

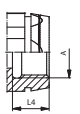
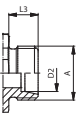
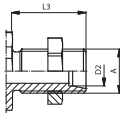
Port A	Dimensions ( <sup>mm</sup> / <sub>in</sub> )					Female Body Ordering Codes	Weight ( <sup>kg</sup> / <sub>lbs</sub> ) ca. per 100	Male Tip Ordering Codes	Weight ( <sup>kg</sup> / <sub>lbs</sub> ) ca. per 100
	ØD2	L1	L2	L3	L4				
<b>Female Thread according to DIN 3852-2-A - ANSI B 1.20.3</b>									
	G1/4"	64	44		13	QRC-HPA-06-F-G04-BT-W66	14,60 32.19	QRC-HPA-06-M-G04-B-W66	5,20 11.46
	NPTF 1/4" -18	64	44			QRC-HPA-06-F-NF04-BT-W66	15 33.07	QRC-HPA-06-M-NF04-B-W66	5,20 11.46
<b>Male Thread with 24° Conical Bore - Shape W according to DIN 3861</b>									
	M14x1,5	8L	62	42	10	QRC-HPA-06-F-08L-BT-W66	13,40 29.54	QRC-HPA-06-M-08L-B-W66	4 8.82
			2.44	1.65	.39				
<b>Male Thread with 24° Conical Bore - Bulkhead - Shape W according to DIN 3861</b>									
	M14x1,5	8L	77	59	25	QRC-HPA-06-F-08LB-BT-W66	15,40 33.95	QRC-HPA-06-M-08LB-B-W66	6,20 13.67
			3.01	2.30	.98				

Note: The connection of the two halves of a coupling is achieved depending on the type. It is important to observe the positive engagement of plug-type couplings and the secure tightening of screw-type couplings to the limit stop of the thread. Forced or improper separation will result in malfunction of the coupling.



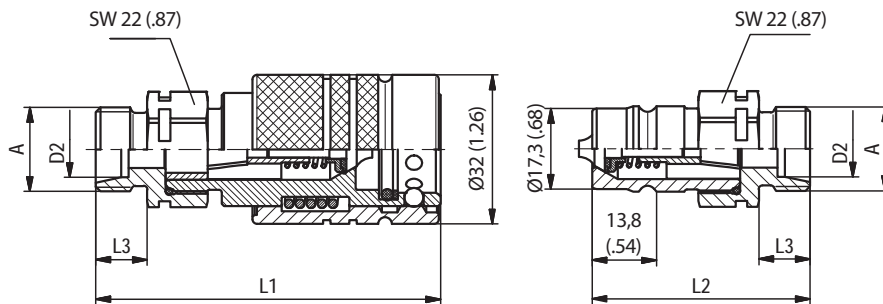

SW: Width across flats. All dimensions in mm (inch).

Dimensions acc. to ISO 7241-1, Series A, Size 10.

HP/HU

Series HP-10 • BG 2 • Nominal Size 10

Port A	Dimensions ( <sup>mm</sup> / <sub>in</sub> )					Female Body Ordering Codes	Weight ( <sup>kg</sup> / <sub>lbs</sub> ) ca. per 100	Male Tip Ordering Codes	Weight ( <sup>kg</sup> / <sub>lbs</sub> ) ca. per 100
	ØD2	L1	L2	L3	L4				
<b>Male Thread according to ISO 1179-4-B</b>									
	G3/8"		77	51	12	QRC-HP-10-F-B06-BT-W66	2,20	QRC-HP-10-M-B06-B-W66	7,80
			3.03	2.01	.47		4.85		17.2
<b>Female Thread according to DIN 3852-2-A - ISO 9974-1 - ANSI B 1.20.3</b>									
	G1/4"		76	49		13	19,50	QRC-HP-10-M-G04-B-W66	88
			2.99	1.93		.51	42.99	193.60	
	G3/8"		76	49		13	18,80	QRC-HP-10-M-G06-B-W66	80
			2.99	1.93		.51	41.45	176.00	
	M16x1,5		76	49		13	18,80	QRC-HP-10-M-M16-B-W66	81
		2.99	1.93		.51	41.45	178.20		
	NPTF 3/8"-18		76	49			18,80	QRC-HP-10-M-NF06-B-W66	81
		2.99	1.93			41.45	178.20		
<b>Male Thread with 24° Conical Bore - Shape W according to DIN 3861</b>									
	M14x1,5	8L	73	46	10		21	QRC-HP-10-M-08L-B-W66	4,20
			2.87	1.81	.39		46.30	9.26	
	M16x1,5	10L	74	47	11		21	QRC-HP-10-M-10L-B-W66	6,50
			2.91	1.85	.43		46.30	14.33	
	M18x1,5	12L	74	47	11		21,50	QRC-HP-10-M-12L-B-W66	7,30
			2.91	1.84	.43		47.40	16,09	
	M16x1,5	8S	75	48	12		21,20	QRC-HP-10-M-08S-B-W66	7,10
			2.95	1.89	.47		46.74	15.65	
	M18x1,5	10S	75	48	12		21,60	QRC-HP-10-M-10S-B-W66	7,20
			2.95	1.89	.47		47.62	15.87	
	M20x1,5	12S	75	48	12		21,60	QRC-HP-10-M-12S-B-W66	7,40
			2.95	1.89	.47		47.62	16.31	
<b>Male Thread with 24° Conical Bore - Bulkhead - Shape W according to DIN 3861</b>									
	M14x1,5	8L	88	61	25		22,80	QRC-HP-10-M-08LB-B-W66	8,40
			3.46	2.39	.98		50.27	18.51	
	M16x1,5	10L	89	62	26		23,40	QRC-HP-10-M-10LB-B-W66	9
			3.50	2.43	1.02		51.59	19.84	
	M18x1,5	12L	89	62	26		23,50	QRC-HP-10-M-12LB-B-W66	9,40
			3.50	2.43	1.02		51.81	20.72	
	M16x1,5	08S	90	63	27		23	QRC-HP-10-M-08SB-B-W66 *	10
			3.54	2.47	1.06		50.71	22.05	
	M20x1,5	12S	90	63	27		22	QRC-HP-10-M-12SB-B-W66 *	7,40
			3.54	2.47	1.06		48.50	16.31	

\* Available on request.

Note: The connection of the two halves of a coupling is achieved depending on the type. It is important to observe the positive engagement of plug-type couplings and the secure tightening of screw-type couplings to the limit stop of the thread. Forced or improper separation will result in malfunction of the coupling.



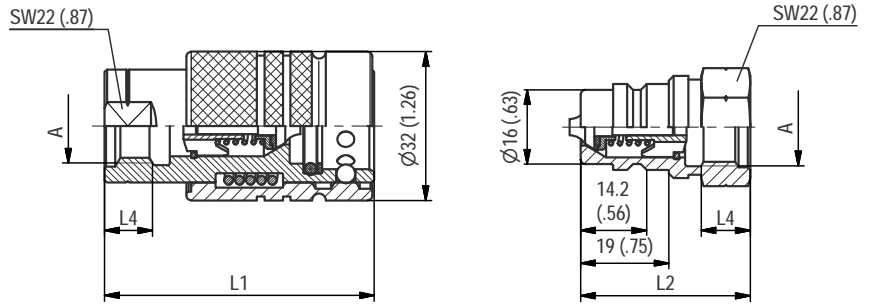

SW: Width across flats. All dimensions in mm (inch).

**Series HP-10A ▪ BG 2 ▪ Nominal Size 10**
**HP/HU**

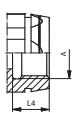
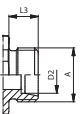
Port A	Dimensions ( <sup>mm</sup> / <sub>in</sub> )					Female Body Ordering Codes	Weight ( <sup>kg</sup> / <sub>lbs</sub> ) ca. per 100	Male Tip Ordering Codes	Weight ( <sup>kg</sup> / <sub>lbs</sub> ) ca. per 100
	ØD2	L1	L2	L3	L4				
<b>Female Thread according to DIN 3852-2-A - ANSI B 1.20.3</b>									
	G3/8"		58	37	14	QRC-HPA-10-F-G06-BT-W66	18,80	QRC-HPA-10-M-G06-B-W66	5,10
			2.28	1.46	.55		41.45		11.24
<b>Male Thread with 24° Conical Bore - Bulkhead - Shape W according to DIN 3861</b>									
	M16x1,5	10L	58	37	14	QRC-HPA-10-F-10L-BT-W66	22,60	QRC-HPA-10-M-10L-B-W66	8,80
			2.28	1.44	.55		49.82		19.40

Note: The connection of the two halves of a coupling is achieved depending on the type. It is important to observe the positive engagement of plug-type couplings and the secure tightening of screw-type couplings to the limit stop of the thread. Forced or improper separation will result in malfunction of the coupling.



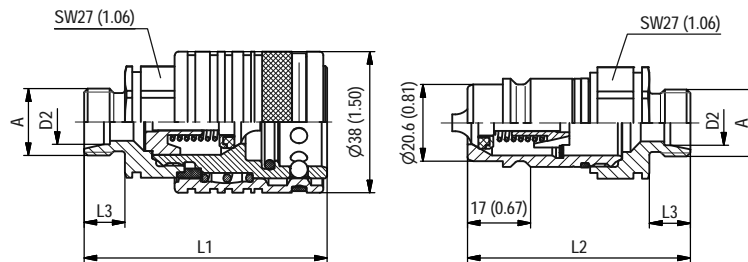

SW: Width across flats. All dimensions in mm (inch).

Dimensions acc. to ISO 7241-1, Series A, Size 12,5 and ISO 5675.

HP/HU

Series HP-12 ▪ BG 3 ▪ Nominal Size 12,5

Port A	Dimensions ( <sup>mm</sup> / <sub>in</sub> )					Female Body Ordering Codes	Weight ( <sup>kg</sup> / <sub>lbs</sub> ) ca. per 100	Male Tip Ordering Codes	Weight ( <sup>kg</sup> / <sub>lbs</sub> ) ca. per 100
	ØD2	L1	L2	L3	L4				
<b>Male Thread according to ISO 1179-4-B - ISO 9974-3</b>									
	G 3/8"	71 2.80	61 2.40	12 .47		QRC-HP-12-F-B06-B-W3	29 63.93	QRC-HP-12-M-B06-B-W3	11,90 26.24
	G 1/2"	71 2.80	61 2.40	12 .47		QRC-HP-12-F-B08-B-W3	29,60 65.26	QRC-HP-12-M-B08-B-W3	12,30 27.12
	M22x1,5	71 2.80	61 2.40	12 .47		QRC-HP-12-F-M22M-B-W3	30 66.14	QRC-HP-12-M-M22M-B-W3	12,90 28.44
<b>Female Thread according to DIN 3852-2-A - ISO 6149-1 - ISO 9974-1 - ANSI B 1.20.3 - SAE J1926-1 - ISO 11926-1</b>									
	G3/8"	68 2.68	60 2.36		15 .59	QRC-HP-12-F-G06-B-W3	33,10 72.97	QRC-HP-12-M-G06-B-W3	15,30 33.73
		G 1/2"	70 2.76	48 1.89		17 .67	QRC-HP-12-F-G08-B-W3	28 61.73	QRC-HP-12-M-G08-B-W3
	M16x1,5		67 2.65	62 2.43		15 .59	QRC-HP-12-F-M160R-B-W3	31,80 70.11	QRC-HP-12-M-M160R-B-W3
		M18x1,5	68 2.68	60 2.36		15 .59	QRC-HP-12-F-M180R-B-W3	31,80 70.11	QRC-HP-12-M-M180R-B-W3
	M22x1,5		70 2.76	48 1.89		17 .67	QRC-HP-12-F-M22-B-W3	28,40 62.61	QRC-HP-12-M-M220R-B-W3
		NPTF 1/2"-14	70 2.76	48 1.89			QRC-HP-12-F-NF08-B-W3	29,40 64.82	QRC-HP-12-M-NF08-B-W3
	UNF 3/4"-16		77 3.03	48 1.89		14 .55	QRC-HP-12-F-U08-B-W3	27,80 61.29	QRC-HP-12-M-U08-B-W3

Note: The connection of the two halves of a coupling is achieved depending on the type. It is important to observe the positive engagement of plug-type couplings and the secure tightening of screw-type couplings to the limit stop of the thread. Forced or improper separation will result in malfunction of the coupling.



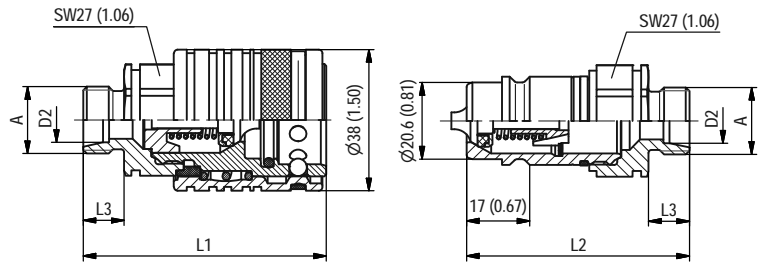

SW: Width across flats. All dimensions in mm (inch).

Dimensions acc. to ISO 7241-1, Series A, Size 12,5 and ISO 5675.

**Series HP-12 ▪ BG 3 ▪ Nominal Size 12,5**
**HP/HU**

Port A	Dimensions ( <sup>mm</sup> / <sub>in</sub> )					Female Body	Weight ( <sup>kg</sup> / <sub>lbs</sub> ) ca. per 100	Male Tip	Weight ( <sup>kg</sup> / <sub>lbs</sub> ) ca. per 100
	ØD2	L1	L2	L3	L4	Ordering Codes		Ordering Codes	
<b>Male Thread with 24° Conical Bore - Shape W according to DIN 3861</b>									
	M14x1,5	8L	64 2.53	58 2.30	10 .39	QRC-HP-12-F-08L-B-W3	26,20 57.76	QRC-HP-12-M-08L-B-W3	10,70 23.59
	M16x1,5	10L	65 2.57	60 2.35	11 .43	QRC-HP-12-F-10L-B-W3	25,70 56.66	QRC-HP-12-M-10L-B-W3	10,90 24.03
	M18x1,5	12L	65 2.57	60 2.35	11 .43	QRC-HP-12-F-12L-B-W3	25,70 56.66	QRC-HP-12-M-12L-B-W3	10,90 24.03
	M22x1,5	15L	66 2.61	61 2.39	12 .47	QRC-HP-12-F-15L-B-W3	26,50 58.42	QRC-HP-12-M-15L-B-W3	11,70 25.79
	M26x1,5	18L	66 2.61	61 2.39	12 .47	QRC-HP-12-F-18L-B-W3	27,30 60.19	QRC-HP-12-M-18L-B-W3	11,90 26.24
	M18x1,5	10S	66 2.61	61 2.39	12 .47	QRC-HP-12-F-10S-B-W3	26,50 58.42	QRC-HP-12-M-10S-B-W3	11,50 25.35
	M20x1,5	12S	66 2.61	61 2.39	12 .47	QRC-HP-12-F-12S-B-W3	26,70 58.86	QRC-HP-12-M-12S-B-W3	11,70 25.79
	M22x1,5	14S	68 2.69	63 2.47	14 .55	QRC-HP-12-F-14S-B-W3	27,30 60.19	QRC-HP-12-M-14S-B-W3	12,30 27.12
	M24x1,5	16S	68 2.69	63 2.47	14 .55	QRC-HP-12-F-16S-B-W3	27,50 60.63	QRC-HP-12-M-16S-B-W3	12,50 27.56
	<b>Male Thread with 24° Conical Bore - Bulkhead - Shape W according to DIN 3861</b>								
	M14x1,5	08L	80 3.16	75 2.94	26 1.02	QRC-HP-12-F-08LB-B-W3	28,20 62.17	QRC-HP-12-M-08LB-B-W3	12,90 28.44
	M16x1,5	10L	80 3.16	75 2.94	26 1.02	QRC-HP-12-F-10LB-B-W3	28,80 63.49	QRC-HP-12-M-10LB-B-W3	13,50 29.76
	M18x1,5	12L	84 3.31	79 3.10	30 1.18	QRC-HP-12-F-12LB-B-W3	29,10 64.15	QRC-HP-12-M-12LB-B-W3	14,30 31.53
	M22x1,5	15L	81 3.19	76 2.98	27 1.06	QRC-HP-12-F-15LB-B-W3	30,70 67.68	QRC-HP-12-M-15LB-B-W3	15,90 35.05
	M26x1,5	18L	81 3.20	76 2.98	27 1.06	QRC-HP-12-F-18LB-B-W3	34,10 75.18	QRC-HP-12-M-18LB-B-W3	19,30 42.55
	M18x1,5	10S	80 3.16	75 2.94	26 1.02	QRC-HP-12-F-10SB-B-W3	29,70 65.48	QRC-HP-12-M-10SB-B-W3	14,70 32.41
	M20x1,5	12S	81 3.20	76 2.98	27 1.06	QRC-HP-12-F-12SB-B-W3	30,50 67.24	QRC-HP-12-M-12SB-B-W3	15,50 34.17
	M22x1,5	14S	83 3.28	78 3.06	29 1.14	QRC-HP-12-F-14SB-B-W3	31,90 70.33	QRC-HP-12-M-14SB-B-W3	17,10 37.70
	M24x1,5	16S	83 3.28	78 3.06	29 1.14	QRC-HP-12-F-16SB-B-W3	33,30 73.41	QRC-HP-12-M-16SB-B-W3	18,30 40.34

Note: The connection of the two halves of a coupling is achieved depending on the type. It is important to observe the positive engagement of plug-type couplings and the secure tightening of screw-type couplings to the limit stop of the thread. Forced or improper separation will result in malfunction of the coupling.



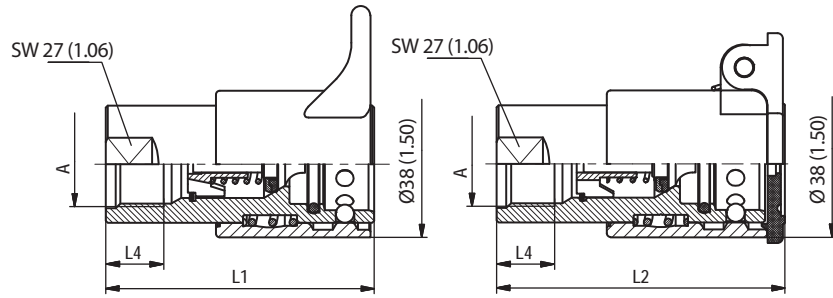





SW: Width across flats. All dimensions in mm (inch).

Dimensions acc. to ISO 7241-1, Series A, Size 12,5 and ISO 5675.

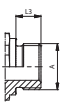
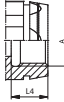
HP/HU

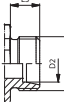
Series ZP-12 ▪ BG 3 ▪ Nominal Size 12,5

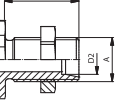
Port A	Dimensions (mm/in)					Female Body Ordering Codes	Weight (kg/lbs) ca. per 100	Male Tip Ordering Codes	Weight (kg/lbs) ca. per 100
	ØD2	L1	L2	L3	L4				
<b>Male Thread according to DIN 3852</b>									
 G 1/2"		74		12		QRC-ZP-12-F-B08-B-W3	31,40		
		2.92		.47			69.23		
<b>Female Thread according to DIN 3852-2 - ISO 9974-1</b>									
 G1/2"		70			17	QRC-ZP-12-F-G08-B-W3	31,40		
		2.76			.67		69.23		
 M22x1,5		70	75		17	QRC-ZP-12-F-M22-B-W3	31	QRC-ZP-12-FF-M22/L-B-W3-SW	30,50
		2.76	2.95		.67		68.34		67.24
<b>Male Thread with 24° Conical Bore - Shape W according to DIN 3861</b>									
 M18x1,5	12L	70			11	QRC-ZP-12-F-12L-B-W3	30,10		
		2.76			.43		66.36		
 M22x1,5	15L	71			12	QRC-ZP-12-F-15L-B-W3	30,90		
		2.80			.47		68.12		
<b>Male Thread with 24° Conical Bore - Bulkhead - Shape W according to DIN 3861</b>									
 M18x1,5	12L	89	93	30		QRC-ZP-12-F-12LB-B-W3	33,50	QRC-ZP-12-FF-12LB/S-B-W3-SW	36,20
			3.51	3.67	1.18				73.85
	15L	86	90	27		QRC-ZP-12-F-15LB-B-W3	35,10	QRC-ZP-12-FF-15LB/S-B-W3-SW	38,90
			3.39	3.55	1.06				77.38
12S		90	27				QRC-ZP-12-FF-12SB/L-B-W3-SW	39,30	
			3.55	1.06				86.64	
16S		92	29				QRC-ZP-12-FF-16SB/L-B-W3-SW	41,50	
			3.63	1.14				91.49	

Note: The connection of the two halves of a coupling is achieved depending on the type. It is important to observe the positive engagement of plug-type couplings and the secure tightening of screw-type couplings to the limit stop of the thread. Forced or improper separation will result in malfunction of the coupling.





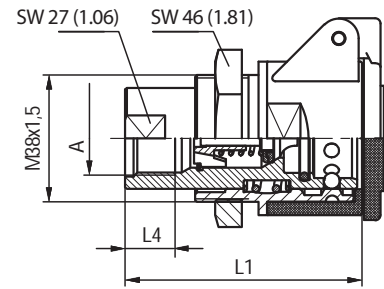
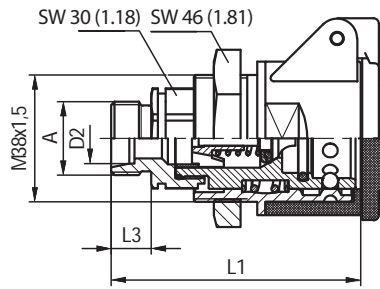

SW: Width across flats. All dimensions in mm (inch).

Dimensions acc. to ISO 7241-1, Series A, Size 12,5 and ISO 5675.

**Series AP-12 • BG 3 • Nominal Size 12,5**
**HP/HU**

Port A	Dimensions (mm/in)					Female Body Ordering Codes	Weight (kg/lbs) ca. per 100
	ØD2	L1	L2	L3	L4		
<b>Innengewinde entsprechend ISO 9974-1</b>							
	M22x1,5		75		15	QRC-AP-12-FF-M22M30-B-W3-RD/BK	38,10
			2.95		.59		84
<b>Male Thread with 24° Conical Bore - Shape W according to DIN 3861</b>							
	M22x1,5	15L	72	12		QRC-AP-12-FF-15L-B-W3-RD/BK	39
			2.84	.47			85.98

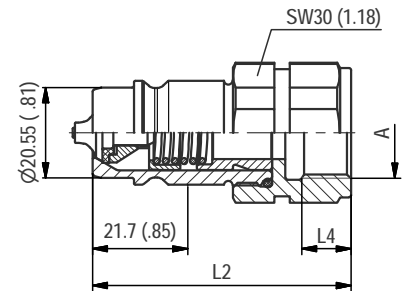

SW: Width across flats. All dimensions in mm (inch).

 Male Tip Connect Under Pressure - use our HP-12 Female side.  
 Dimensions acc. to ISO 7241-1, Series A

**Series HU-12 • BG 3 • Nominal Size 12,5 • Connect Under Pressure**

Port A	Dimensions (mm/in)					Male Tip Ordering Codes	Weight (kg/lbs) ca. per 100
	ØD2	L1	L2	L3	L4		
<b>Female Thread according to DIN 3852-2-A - ANSI B 1.20.3</b>							
	G3/8"		46		12	QRC-HU-12-M-G06-B-W3	16,60
			1.81	.47	36,60		
	NPTF 3/8" -18		46			QRC-HU-12-M-NF06-B-W3	19,20
			1.81	42,33			
	G1/2"		46		14	QRC-HU-12-M-G08-B-W3	16,20
			1.81	.55	35,71		
	NPTF 1/2" -14		46			QRC-HU-12-M-NF08-B-W3	17,60
			1.81	38,80			

Note: The connection of the two halves of a coupling is achieved depending on the type. It is important to observe the positive engagement of plug-type couplings and the secure tightening of screw-type couplings to the limit stop of the thread. Forced or improper separation will result in malfunction of the coupling.



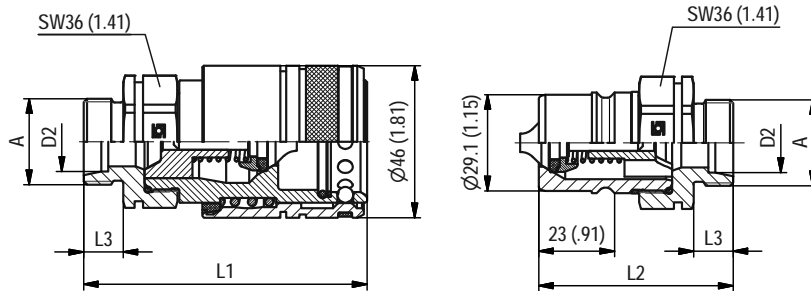

SW: Width across flats. All dimensions in mm (inch).

Dimensions acc. to ISO 7241-1, Series A, Size 19 and ISO 5675.

HP/HU

Series HP-19 • BG 4 • Nominal Size 19

Port A	Dimensions (mm/in)					Female Body Ordering Codes	Weight ( <sup>kg</sup> /lbs) ca. per 100	Male Tip Ordering Codes	Weight ( <sup>kg</sup> /lbs) ca. per 100
	ØD2	L1	L2	L3	L4				
<b>Female Thread according to DIN 3852-2 - ISO 9974-1</b>									
	G3/4"	92	65		19	QRC-HP-19-F-G12-BT-W66	60,50 133.38	QRC-HP-19-M-G12-B-W66	31,50 69.45
	M22x1,5	92	65		19	QRC-HP-19-F-M22-BT-W66	62,80 138.45	QRC-HP-19-M-M22-B-W66	31,30 69
	NPTF 3/4"-14	92	65			QRC-HP-19-F-NF12-BT-W66	62,80 138.45	QRC-HP-19-M-NF12-B-W66	31,30 69
<b>Male Thread with 24° Conical Bore - Shape W according to DIN 3861</b>									
	M18x1,5	12L	85	58	11		54,40 119.93	QRC-HP-19-M-12L-B-W66	22,70 50.04
		15L	86	59	12		54,60 120.37	QRC-HP-19-M-15L-B-W66	23,20 51.15
	M22x1,5	18L	86	59	12		55,50 122.36	QRC-HP-19-M-18L-B-W66	23,80 52.47
		22L	88	61	14		56,90 125.44	QRC-HP-19-M-22L-B-W66	24,80 54.67
	M24x1,5	16S	88	61	14		56 123.46	QRC-HP-19-M-16S-B-W66	24,20 53.35
		20S	90	63	16		57,20 126.10	QRC-HP-19-M-20S-B-W66	25,20 55.56
	<b>Male Thread with 24° Conical Bore - Bulkhead - Shape W according to DIN 3861</b>								
	M18x1,5	12L	100	73	26		57,40 126.55	QRC-HP-19-M-12LB-B-W66	27,60 60.85
		15L	101	74	27		59 130.07	QRC-HP-19-M-15LB-B-W66	27,40 60.41
	M22x1,5	18L	101	74	27		62,70 138.23	QRC-HP-19-M-18LB-B-W66	31 68.34
		22L	110	83	36		67,50 148.81	QRC-HP-19-M-22LB-B-W66	35,50 78.26
	M24x1,5	16S	103	76	29		61,40 135.36	QRC-HP-19-M-16SB-B-W66	29,80 65.70
		20S	110	83	36		68,50 151.02	QRC-HP-19-M-20SB-B-W66	36,20 79.81

Note: The connection of the two halves of a coupling is achieved depending on the type. It is important to observe the positive engagement of plug-type couplings and the secure tightening of screw-type couplings to the limit stop of the thread. Forced or improper separation will result in malfunction of the coupling.



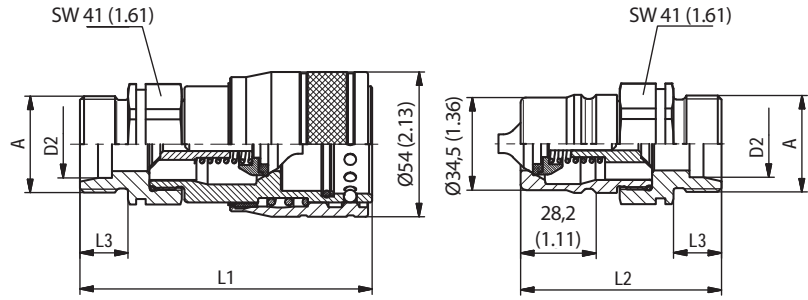

SW: Width across flats. All dimensions in mm (inch).

Dimensions acc. to ISO 7241-1, Series A, Size 25.

**Series HP-25 ▪ BG 6 ▪ Nominal Size 25**
**HP/HU**

Port A	Dimensions ( <sup>mm</sup> / <sub>in</sub> )				Female Body Ordering Codes	Weight ( <sup>kg</sup> / <sub>lbs</sub> ) ca. per 100	Male Tip Ordering Codes	Weight ( <sup>kg</sup> / <sub>lbs</sub> ) ca. per 100	
	ØD2	L1	L2	L3					L4
<b>Female Thread according to DIN 3852-2-A - ANSI B 1.20.3</b>									
	G3/4"	104 4.09	72 2.83		19 .75	QRC-HP-25-F-G12-BT-W66 193.12	QRC-HP-25-M-G12-B-W66	40,90 90.17	
	G1"	104 4.09	72 2.83		19 .75	QRC-HP-25-F-G16-BT-W66 183.87	QRC-HP-25-M-G16-B-W66	36,30 80.03	
	NPTF 1"-11 1/2	104 4.09	72 2.83			QRC-HP-25-F-NF16-BT-W66 183.87	QRC-HP-25-M-NF16-B-W66	36,30 80.03	
<b>Male Thread with 24° Conical Bore - Shape W according to DIN 3861</b>									
	M22x1,5	15L	103 4.06	69 2.72	12 .47	QRC-HP-25-F-15L-BT-W66 175.71	QRC-HP-25-M-15L-B-W66 *	34,60 76.28	
		18L	103 4.06	69 2.72	12 .47	QRC-HP-25-F-18L-BT-W66 179.24	QRC-HP-25-M-18L-B-W66	34,80 76.72	
	M30x2	22L	105 4.13	71 2.80	14 .55	QRC-HP-25-F-22L-BT-W66 180.12	QRC-HP-25-M-22L-B-W66	35,50 78.26	
		28L	105 4.13	71 2.80	14 .55	QRC-HP-25-F-28L-BT-W66 180.56	QRC-HP-25-M-28L-B-W66	36 79.37	
	M45x2	35L	107 4.21	73 2.87	16 .63	QRC-HP-25-F-35L-BT-W66 * 197.53	QRC-HP-25-M-35L-B-W66 *	44,50 98.11	
		20S	107 4.21	73 2.87	16 .63	QRC-HP-25-F-20S-BT-W66 182.54	QRC-HP-25-M-20S-B-W66	36,10 79.59	
	M36x2	25S	109 4.29	75 2.95	18 .71	QRC-HP-25-F-25S-BT-W66 187.39	QRC-HP-25-M-25S-B-W66	38 83.78	
		30S	111 4.37	77 3.03	20 .79	QRC-HP-25-F-30S-BT-W66 180.78	QRC-HP-25-M-30S-B-W66	44 97	
	<b>Male Thread with 24° Conical Bore - Bulkhead - Shape W according to DIN 3861</b>								
		M22x1,5	15L	118 4.65	84 3.31	27 1.06	QRC-HP-25-F-15LB-BT-W66 182.76	QRC-HP-25-M-15LB-B-W66 *	37,80 83.33
18L			123 4.84	89 3.50	32 1.26	QRC-HP-25-F-18LB-BT-W66 187.39	QRC-HP-25-M-18LB-B-W66	42,80 94.36	
M30x2		22L	125 4.92	91 3.58	34 1.34	QRC-HP-25-F-22LB-BT-W66 200.40	QRC-HP-25-M-22LB-B-W66	44 97	
		28L	125 4.92	91 3.58	34 1.34	QRC-HP-25-F-28LB-BT-W66 188.27	QRC-HP-25-M-28LB-B-W66	48,10 106.04	
M30x2		20S	129 5.08	95 3.74	38 1.50	QRC-HP-25-F-20SB-BT-W66 184.09	QRC-HP-25-M-20SB-B-W66	47,40 104.50	
		25S	129 5.08	95 3.74	38 1.50	QRC-HP-25-F-25SB-BT-W66 196.21	QRC-HP-25-M-25SB-B-W66	52,40 115.52	
M42x2		30S	131 5.16	97 3.82	40 1.57	QRC-HP-25-F-30SB-BT-W66 246.70	QRC-HP-25-M-30SB-B-W66	63,40 139.77	

\* Available on request.

Note: The connection of the two halves of a coupling is achieved depending on the type. It is important to observe the positive engagement of plug-type couplings and the secure tightening of screw-type couplings to the limit stop of the thread. Forced or improper separation will result in malfunction of the coupling.



Series HP • Dust Protection

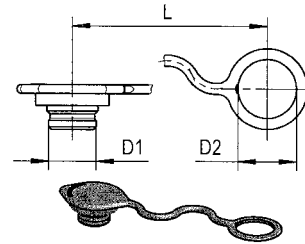
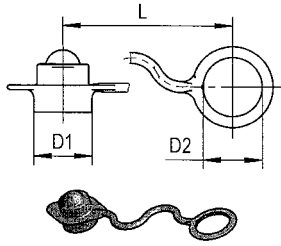

HP/HU

Dimensions (mm/in)			Material	Dust Cap for Male Tip
D1	D2	L		Ordering Codes
28	27	134	Plastic (Colour: Red)	QRC-HP-12-DM-27-K/1-RD
1.10	1.06	5.28		

Dimensions (mm/in)			Material	Dust Plug for Female Body
D1	D2	L		Ordering Codes
22	27	135	Plastic (Colour: Red)	QRC-HP-12-DF-27-K/1-RD
.87	1.06	5.31		

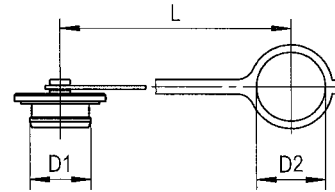
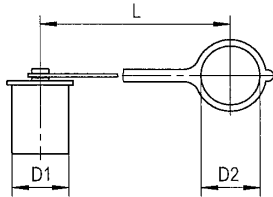

Dimensions (mm/in)			Material	Dust Cap for Male Tip
D1	D2	L		Ordering Codes
22	22	125	Plastic (Colour: Red)	QRC-HP-10-DM-22-K-RD
.87	.87	4.92		
33	37	190	Plastic (Colour: Red)	QRC-HP-19-DM-37-K-RD
1.30	1.46	7.48		
36	41	190	Plastic (Colour: Red)	QRC-HP-25-DM-41-K-RD
1.42	1.61	7.48		

Dimensions (mm/in)			Material	Dust Plug for Female Body
D1	D2	L		Ordering Codes
18	22	125	Plastic (Colour: Red)	QRC-HP-10-DF-22-K-RD
.71	.87	4.92		
30	37	190	Plastic (Colour: Red)	QRC-HP-19-DF-37-K-RD
1.18	1.46	7.48		
36	41	190	Plastic (Colour: Red)	QRC-HP-25-DF-41-K-RD
1.42	1.61	7.48		

Series HU • Dust Protection

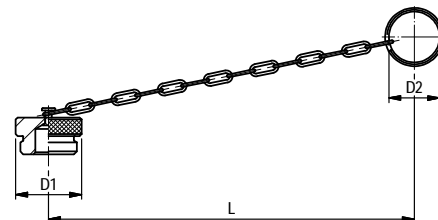
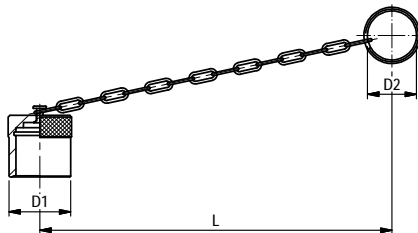

Dimensions (mm/in)			Material	Dust Cap for Male Tip
D1	D2	L		Ordering Codes
38	32	205	Aluminium with chain	QRC-IA-12-DM-32/CN-W89-SI
1.50	1.26	8.07		

Dimensions (mm/in)			Material	Dust Plug for Female Body
D1	D2	L		Ordering Codes
38	32	205	Aluminium with chain	QRC-IA-12-DF-32/CN-W89-SI
1.50	1.26	8.07		

In addition to the standard colours as stated above, plastic dust caps are also available in blue, green, yellow and black. Please use the color codes BU, GN, YE and BK respectively instead of RD.



Series UX • Carbon Steel

Series UX • Overview	54
Series UX-S-12 • BG 3 • Nominal Size 12,5 short version	55
Series UX-L-12 • BG 3 • Nominal Size 12,5 long version	56

UX



### Series UX ▪ Carbon Steel

Material	Carbon Steel
Surface Finishing	Zinc-Plating and Thick-Film-Passivation (Chrome III)
Standard Seal Material(s)	NBR (Buna-N®), PTFE <sup>2</sup>
Working Temperature	-30° C ... +100° C / -22° F ... +212° F
Valve Design	Poppet Valve
Connection	Push
Disconnection	Pull
Connect Under Pressure	Female Body up to max. 2,5 bar / 36 PSI, ISO-A Male Tip up to the max. Working Pressure allowed
Application	Agricultural and Forestry Machinery
ISO Interchange	ISO 7241-1 Series A, Size 12,5



The series UX coupling sleeve is available in two different overall lengths and is therefore compatible with the common commercially available built-in couplings.

<sup>2</sup> Alternative seal materials are available on request.

### Technical Data

UX

Series	BG	DN Zoll	DN metric	Q <sub>max</sub>		Working Pressure		Bursting Pressure Connected*		Female Body		Male Tip		Spillage	
				ISO 4397	l/min	US GPM	bar	PSI	bar	PSI	bar	PSI	bar	PSI	ml
UX-12	3	1/2"	12,5	100	26,42	250	3626	1000	14504	1000	14504	1000	14504	1,7	.0575

The indicated pressure ratings only apply to the coupling itself and depend on the connection type.

\* in connection with QRC-HP-12-M-....

### Flow Characteristics

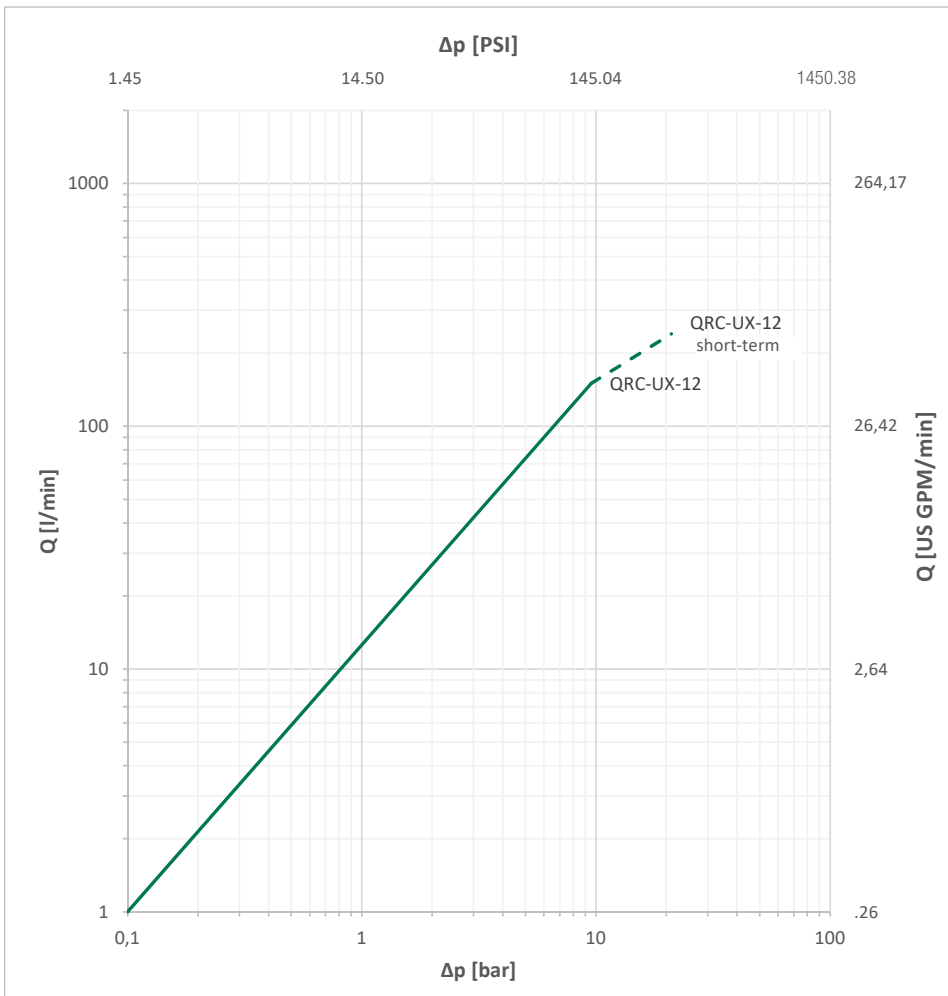

Please note: Unless otherwise stated, all flow characteristics have been determined with hydraulic oil with a kinematic viscosity of 28,8 - 35,2 mm<sup>2</sup>/s (28,8 - 35,2 cSt) and are only valid for components with non-reducing connections.



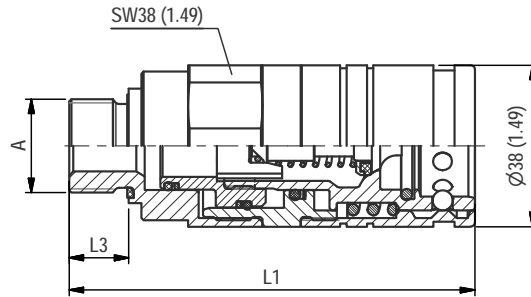

SW: Width across flats. All dimensions in mm (inch).

**Series UX-S-10 ▪ BG 3 ▪ Nominal Size 12,5**
**UX**

Port A	Dimensions ( <sup>mm</sup> / <sub>in</sub> )					Female Body Ordering Codes	Weight ( <sup>kg</sup> / <sub>lbs</sub> ) ca. per 100
	ØD2	L1	L2	L3	L4		
<b>Male Thread according to EN ISO 9974-2, DIN 3852 T11 Shape E</b>							
	M22x1,5		95,5		14	QRC-UX-S-12-F-M22MWD-S1-W66-SM	49,50
			3,76		.55		109,13
<b>Male Thread according to ISO 6149, DIN 3852 T3, Shape C</b>							
	M22x1,5		94		13	QRC-UX-S-12-F-M22MOR-S1-W66-SM	49,20
			3,70		.51		108,47
<b>Male Thread with 24° Conical Bore - Bulkhead - Shape W according to DIN 3861</b>							
	M18x1,5	12L	112,5 4,43		30 1,18	QRC-UX-S-12-F-12LB-S1-W66	50,20 110,67
	M22x1,5	15L	109,5 4,31		27 1,06	QRC-UX-S-12-F-15LB-S1-W66	51,30 113,10
	M26x1,5	18L	109,5 4,31		27 1,06	QRC-UX-S-12-F-18LB-S1-W66	52,70 116,18

**Dust Cover Clips:** Please see page 188.

Note: The connection of the two halves of a coupling is achieved depending on the type. It is important to observe the positive engagement of plug-type couplings and the secure tightening of screw-type couplings to the limit stop of the thread. Forced or improper separation will result in malfunction of the coupling.



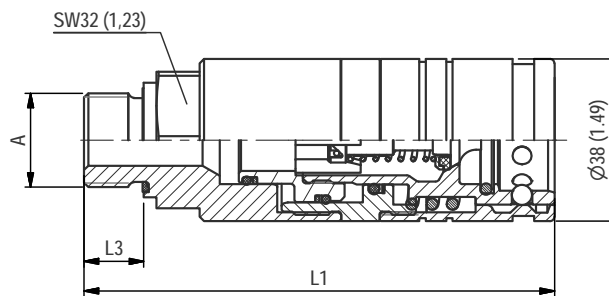

SW: Width across flats. All dimensions in mm (inch).

**Series UX-L-10 • BG 3 • Nominal Size 12,5**

UX

Port A	Dimensions ( <sup>mm</sup> / <sub>in</sub> )					Female Body Ordering Codes	Weight ( <sup>kg</sup> / <sub>lbs</sub> ) ca. per 100	
	ØD2	L1	L2	L3	L4			
<b>Male Thread according to EN ISO 9974-2, DIN 3852 T11 Shape E</b>								
	M22x1,5		110,3		14	QRC-UX-L-12-F-M22MWD-S1-W66-SM	59,60	
			4.34		.55		131.40	
<b>Male Thread according to ISO 6149, DIN 3852 T3, Shape C</b>								
	M18x1,5		110,8		14	QRC-UX-L-12-F-M18MOR-S1-W66-SM	61,90	
			4.36		.55		136.47	
	M22 x 1,5		110,8		14	QRC-UX-L-12-F-M22MOR-S1-W66-SM	59,60	
			4.36		.55		131.40	
<b>Male Thread with 24° Conical Bore - Bulkhead - Shape W according to DIN 3861</b>								
	M18x1,5	12L	121,5		26	QRC-UX-L-12-F-12LB-S1-W66	60,20	
			4.78		1.02		132.72	
	M22 x 1,5	15L	123,5		26	QRC-UX-L-12-F-15LB-S1-W66	62,90	
			4.86		1.02		138.67	
<b>Female Thread according to ISO 1179 - ANSI B 1.20.3 - SAE J1926-1 - ISO 11926-1</b>								
	G1/2"		107,3		15	QRC-UX-L-12-F-G08-S1-W66	60,40	
			4.22		.59		133.16	
	NPTF 1/2"-14		107,3			QRC-UX-L-12-F-NF08-S1-W66	60,80	
			4.22				134.04	
UNF 3/4"-16		107,3		14	QRC-UX-L-12-F-U08-S1-W66	60,90		
		4.22		.55		134.26		
<b>Banjo screw for banjos according to DIN 7643</b>								
M22x1,5	18		134,8		39	14	QRC-UX-L-12-F-BS22-S1-W66	61,20
			5.31		1.54	.55		134.92

Dust Cover Clips: Please see page 188.

Note: The connection of the two halves of a coupling is achieved depending on the type. It is important to observe the positive engagement of plug-type couplings and the secure tightening of screw-type couplings to the limit stop of the thread. Forced or improper separation will result in malfunction of the coupling.





Series IA - Carbon Steel

Series IA - Overview	58	Series IA-38 - BG 8 - Nominal Size 38	61
Series IA-06 - BG 1 - Nominal Size 6,3	59	Series IA-51 - BG 9 - Nominal Size 51	61
Series IA-10 - BG 2 - Nominal Size 10	59	Series IA - Dust Protection	62
Series IA-12 - BG 3 - Nominal Size 12,5	60		
Series IA-19 - BG 4 - Nominal Size 19	60		
Series IA-25 - BG 6 - Nominal Size 25	61		
Series IA-31 - BG 7 - Nominal Size 31,5	61		

IA



### Series IA - Carbon Steel

Material	Carbon Steel
Surface Finishing	Zinc-Nickel
Standard Seal Material(s)	NBR (Buna-N®) <sup>2</sup>
Working Temperature	-25° C ... +100° C / -13° F ... +212° F
Valve Design	Poppet Valve
Connection	Push and actuate Push Sleeve
Disconnection	Actuate Push Sleeve
Connect Under Pressure	not allowed
Application	Agricultural and Forestry Machinery
ISO Interchange	ISO 7241-1, Series A



<sup>2</sup>Alternative seal materials are available on request.

### Technical Data

Series	BG	DN Zoll	DN metric ISO 4397	Q <sub>max</sub>		Working Pressure		Bursting Pressure Connected		Female Body		Male Tip		Spillage	
				l/min	US GPM	bar	PSI	bar	PSI	bar	PSI	bar	PSI	ml	fl oz
IA-06	1	1/4"	6,3	17	4.49	350	5076	1400	20305	1700	24656	1500	21756	0,5	.0169
IA-10	2	3/8"	10	46	12.15	275	3989	1500	21756	1500	21756	1400	20305	1,9	.0642
IA-12	3	1/2"	12,5	90	23.78	275	3989	1200	17405	1400	20305	1000	14504	2,7	.0913
IA-19	4	3/4"	19 (20)	190	50.19	200	2901	1000	14504	1500	21756	900	13053	9,3	.3145
IA-25	6	1"	25	280	73.97	200	2901	1000	14504	1000	14504	1300	18855	16	.5410
IA-31	7	1 1/4"	31	480	126.80	200	2901							30	10.144
IA-38	8	1 1/2"	38	757	199.98	130	1885	820	11893	800	11603	800	11603	54	18.260
IA-51	9	2"	51	1000	264.17	130	1885							120	40.577

The indicated pressure ratings only apply to the coupling itself and depend on the connection type.

### Flow Characteristics

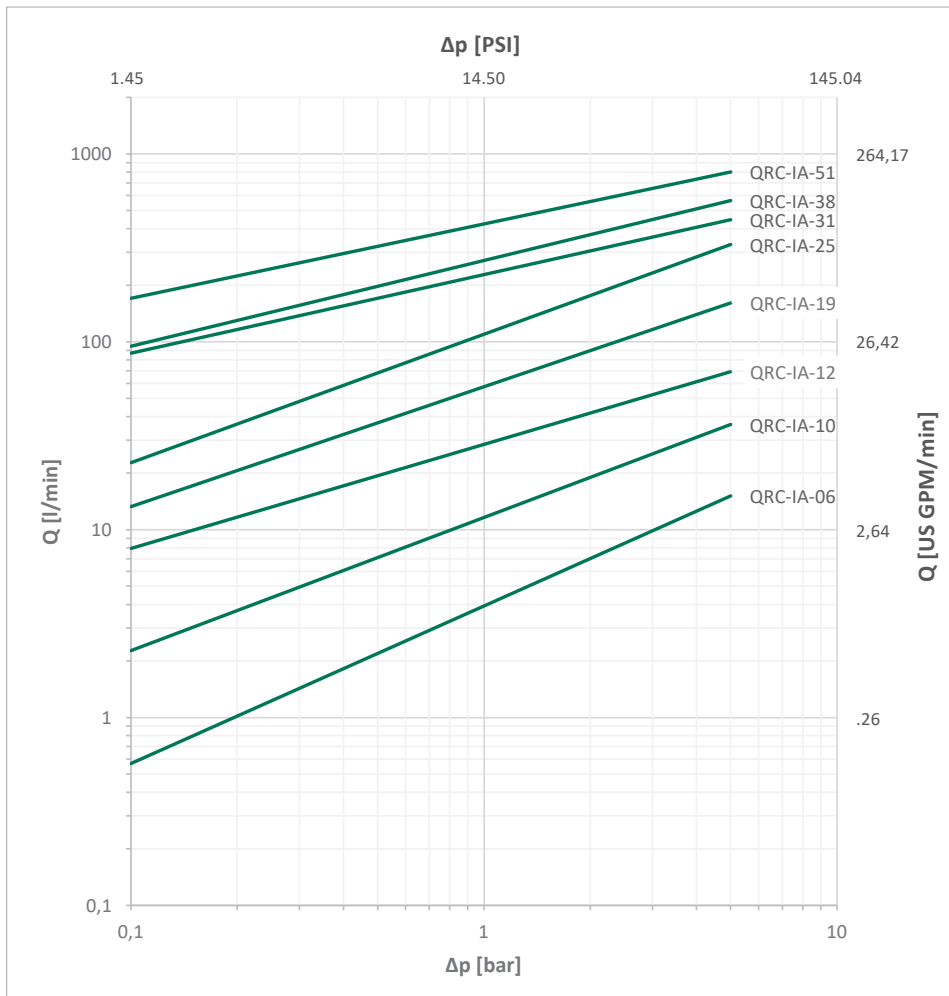

Please note: Unless otherwise stated, all flow characteristics have been determined with hydraulic oil with a kinematic viscosity of 28,8 - 35,2 mm<sup>2</sup>/s (28,8 - 35,2 cSt) and are only valid for components with non-reducing connections.



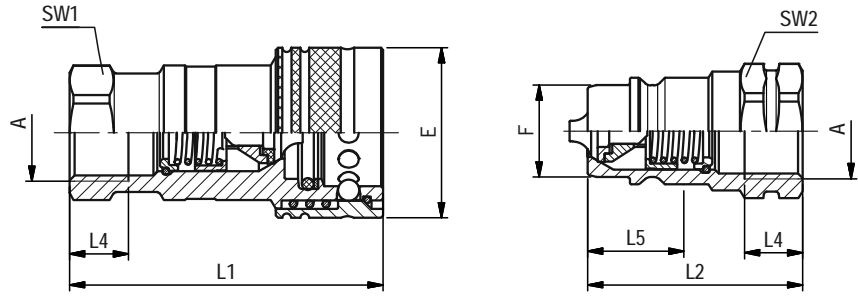

SW: Width across flats. All dimensions in mm (inch). Drawing similar Series IA-12.  
\* Insertion Male Tip.

### Series IA-06 • BG 1 • Nominal Size 6,3

Port A	Dimensions (mm/in)								Female Body Ordering Codes	Weight (kg/lbs) ca. per 100	Male Tip Ordering Codes	Weight (kg/lbs) ca. per 100	
	ØE	ØF	L1	L2	L4 min	L5	SW1	SW2					
<b>Female Thread according to DIN 3852 - ISO 1179-1 - ANSI B 1.20.3</b>													
	G1/4"	26	11,8	50	35,5	13	14	19	19	QRC-IA-06-F-G04-BT-W3	9,50	QRC-IA-06-M-G04-B-W3	3,50
		1.02	.46	1.97	1.40	.51	.55	.75	.75		23.37		8.16
	NPTF 1/4" -18	26	11,8	50	35,5		14	19	19	QRC-IA-06-F-NF04-BT-W3	10,70	QRC-IA-06-M-NF04-B-W3	3,80
		1.02	.46	1.97	1.40		.55	.19	.19		23.59		8.38
<b>Female Thread according to SAE J 1926-1</b>													
	UNF 9/16" -18	26	11,8	50	35,5	12,7	14	19	19	QRC-IA-06-F-U06-BT-W3	10,20	QRC-IA-06-M-U06-B-W3	3,40
		1.02	.46	1.97	1.40	.5	.55	.19	.19		22.49		7.50

### Series IA-10 • BG 2 • Nominal Size 10

Port A	Dimensions (mm/in)								Female Body Ordering Codes	Weight (kg/lbs) ca. per 100	Male Tip Ordering Codes	Weight (kg/lbs) ca. per 100	
	ØE	ØF	L1	L2	L4 min	L5	SW1	SW2					
<b>Female Thread according to DIN 3852 - ISO 1179-1 - ANSI B 1.20.3</b>													
	G 3/8"	31,5	17,3	56	36,5	14	18	22	22	QRC-IA-10-F-G06-BT-W3	14,76	QRC-IA-10-M-G06-B-W3	4,10
		1.24	.68	2.20	1.44	.55	.71	.87	.87		31.09		9.04
	NPTF 3/8" -18	31,5	17,3	56	36,5		18	22	22	QRC-IA-10-F-NF06-BT-W3	14,82	QRC-IA-10-M-NF06-B-W3	4,96
		1.24	.68	2.20	1.44		.71	.87	.87		32.67		10.93
<b>Female Thread according to SAE J 1926-1</b>													
	UNF 9/16" -18	31,5	17,3	56	36,5	14	18	22	22	QRC-IA-10-F-U06-BT-W3	17,50	QRC-IA-10-M-U06-B-W3	7,90
		1.24	.68	2.20	1.44	.55	.71	.87	.87		38.58		17.42
	UNF 3/4" -16	31,5	17,3	56	36,5	14,3	18	22	22	QRC-IA-10-F-U08-BT-W3	19,40	QRC-IA-10-M-U08-B-W3	6,30
		1.24	.68	2.20	1.44	.56	.71	.87	.87		42.77		13.89

Note: The connection of the two halves of a coupling is achieved depending on the type. It is important to observe the positive engagement of plug-type couplings and the secure tightening of screw-type couplings to the limit stop of the thread. Forced or improper separation will result in malfunction of the coupling.



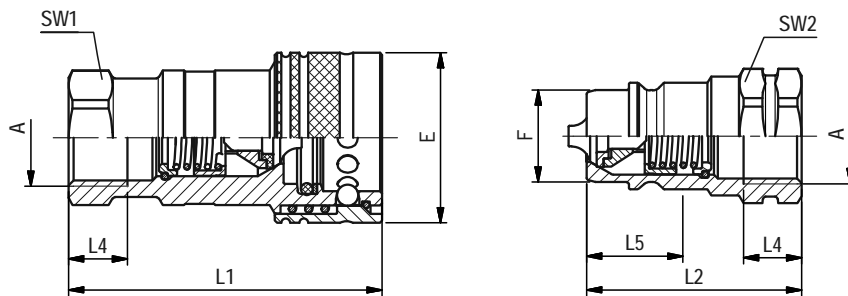

SW: Width across flats. All dimensions in mm (inch). Drawing similar Series IA-12.  
\* Insertion Male Tip.

**Series IA-12 • BG 3 • Nominal Size 12,5**

Port A	Dimensions (mm/in)								Female Body Ordering Codes	Weight (kg/lbs) ca. per 100	Male Tip Ordering Codes	Weight (kg/lbs) ca. per 100
	ØE	ØF	L1	L2	L4 min	L5	SW1	SW2				
Female Thread according to DIN 3852 - ISO 1179-1 - ANSI B 1.20.3 - ISO 9974-1												
	M22x1,5	38,6 1.52	20,5 .81	66 2.60	43,5 1.71	14 .55	21,7 .85	27 1.06	27 1.06	QRC-IA-12-F-M22-BT-W3 26,00 57.32	QRC-IA-12-M-M22-B-W3 9,00 19.84	
	G 1/2"	38,6 1.52	20,5 .81	66 2.60	43,5 1.71	16 .63	21,7 .85	27 1.06	27 1.06	QRC-IA-12-F-G08-BT-W3 24,60 54.23	QRC-IA-12-M-G08-B-W3 6,40 14.11	
	NPTF 1/2" -14	38,6 1.52	20,5 .81	66 2.60	43,5 1.71		21,7 .85	27 1.06	27 1.06	QRC-IA-12-F-NF08-BT-W3 25,64 56.53	QRC-IA-12-M-NF08-B-W3 8,60 18.96	
	NPTF 3/4" -14	38 1.5	20,55 .81	70 2.76	48 1.89		21,5 .85	27 1.06	27 1.06	QRC-IA-12-F-NF12-BT-W3 35,30 77.82	QRC-IA-12-M-NF12-B-W3 9,80 21.61	
Female Thread according to SAE J 1926-1												
	UNF 3/4" -16	38,6 1.52	20,5 .81	66 2.60	43,5 1.71	14,3 .56	21,7 .85	27 1.06	27 1.06	QRC-IA-12-F-U08-BT-W3 27,40 60.41	QRC-IA-12-M-U08-B-W3 10,10 22.27	
	UNF 7/8" -14	38,6 1.52	20,5 .81	66 2.60	43,5 1.71	16,7 .66	21,7 .85	27 1.06	27 1.06	QRC-IA-12-F-U10-BT-W3 26,00 57.32	QRC-IA-12-M-U10-B-W3 10,10 22.27	

**Series IA-19 • BG 4 • Nominal Size 19**

Port A	Dimensions (mm/in)								Female Body Ordering Codes	Weight (kg/lbs) ca. per 100	Male Tip Ordering Codes	Weight (kg/lbs) ca. per 100
	ØE	ØF	L1	L2	L4 min	L5	SW1	SW2				
Female Thread according to DIN 3852 - ISO 1179-1 - ANSI B 1.20.3												
	G 3/4"	48 1.89	29,1 1.15	80 3.15	57 2.24	18 .71	27 1.06	34 1.34	35 1.38	QRC-IA-19-F-G12-BT-W3 49,00 108.03	QRC-IA-19-M-G12-B-W3 20,20 39.68	
	NPTF 3/4" -14	48 1.89	29,1 1.15	80 3.15	57 2.24		27 1.06	34 1.34	35 1.38	QRC-IA-19-F-NF12-BT-W3 49,22 108.51	QRC-IA-19-M-NF12-B-W3 18,60 41.01	

Note: The connection of the two halves of a coupling is achieved depending on the type. It is important to observe the positive engagement of plug-type couplings and the secure tightening of screw-type couplings to the limit stop of the thread. Forced or improper separation will result in malfunction of the coupling.



**Series IA-25 ▪ BG 6 ▪ Nominal Size 25**

Port A	Dimensions (mm/in)									Female Body Ordering Codes	Weight ( <sup>kg</sup> /lbs) ca. per 100	Male Tip Ordering Codes	Weight ( <sup>kg</sup> /lbs) ca. per 100	
	ØE	ØF	L1	L2	L4 min	L5	SW1	SW2						
Female Thread according to DIN 3852 - ISO 1179-1 - ANSI B 1.20.3														
	G 1"	56	34,3	94	59,5	21		34	41	41	QRC-IA-25-F-G16-BT-W3	73,20	QRC-IA-25-M-G16-B-W3	25,40
		2.20	1.35	3.70	2.34	.83		1.34	1.61	1.61		161.38		56.00
	NPTF 1" -11 1/2	56	34,3	94	59,5	21			41	41	QRC-IA-25-F-NF16-BT-W3	74,80	QRC-IA-25-M-NF16-B-W3	26,81
		2.20	1.35	3.70	2.34	.83			1.61	1.61		164.91		59.11

**Series IA-31 ▪ BG 7 ▪ Nominal Size 31,5**

Port A	Dimensions (mm/in)									Female Body Ordering Codes	Weight ( <sup>kg</sup> /lbs) ca. per 100	Male Tip Ordering Codes	Weight ( <sup>kg</sup> /lbs) ca. per 100
	ØE	ØF	L1	L2	L4 min	L5	SW1	SW2					
Female Thread according to DIN 3852 - ISO 1179-1 - ANSI B 1.20.3													
	G 1 1/4"	69,5	45	117	75	25		50	50	QRC-IA-31-F-G20-BT-W3	149,80	QRC-IA-31-M-G20-B-W3	55,50
		2.74	1.77	4.61	2.95	.98		1.97	1.97		274.25		118.61
	NPTF 1 1/4" -11 1/2	69,5	45	117	75			50	50	QRC-IA-31-F-NF20-BT-W3	153,20	QRC-IA-31-M-NF20-B-W3	57,20
		2.74	1.77	4.61	2.95			1.97	1.97		337.75		126.10

**Series IA-38 ▪ BG 8 ▪ Nominal Size 38**

Port A	Dimensions (mm/in)									Female Body Ordering Codes	Weight ( <sup>kg</sup> /lbs) ca. per 100	Male Tip Ordering Codes	Weight ( <sup>kg</sup> /lbs) ca. per 100	
	ØE	ØF	L1	L2	L4 min	L5	SW1	SW2						
Female Thread according to DIN 3852 - ISO 1179-1 - ANSI B 1.20.3														
	G 1 1/2"	84,5	55	133	83,5	27		49	41	60	QRC-IA-38-F-G24-BT-W3	212,80	QRC-IA-38-M-G24-B-W3	87,80
		3.33	2.17	5.24	3.29	1.06		1.93	1.61	2.36		469.14		193.57
	NPTF 1 1/2" -11 1/2	84,5	55	133	83,5			49	41	60	QRC-IA-38-F-NF24-BT-W3	246,40	QRC-IA-38-M-NF24-B-W3	93,80
		3.33	2.17	5.24	3.29			1.93	1.61	2.36		543.22		206.79

**Series IA-51 ▪ BG 9 ▪ Nominal Size 51**

Port A	Dimensions (mm/in)									Female Body Ordering Codes	Weight ( <sup>kg</sup> /lbs) ca. per 100	Male Tip Ordering Codes	Weight ( <sup>kg</sup> /lbs) ca. per 100
	ØE	ØF	L1	L2	L4 min	L5	SW1	SW2					
Female Thread according to DIN 3852 - ISO 1179-1 - ANSI B 1.20.3													
	G 2"	99	65	165	105	26		75	75	QRC-IA-51-F-G32-BT-W3	500	QRC-IA-51-M-G32-B-W3	180,40
		3.90	2.56	6.50	4.13	1.02		2.95	2.95		1102.31		397.71
	NPTF 2" -11 1/2	99	65	165	105	26		75	75	QRC-IA-51-F-NF32-BT-W3	501	QRC-IA-51-M-NF32-B-W3	182
		3.90	2.56	6.50	4.13	1.02		2.95	2.95		1104.52		401.24

Note: The connection of the two halves of a coupling is achieved depending on the type. It is important to observe the positive engagement of plug-type couplings and the secure tightening of screw-type couplings to the limit stop of the thread. Forced or improper separation will result in malfunction of the coupling.



Series IA - Dust Protection

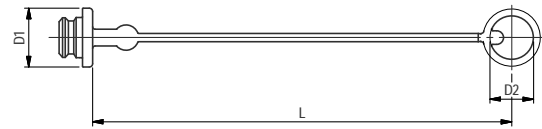
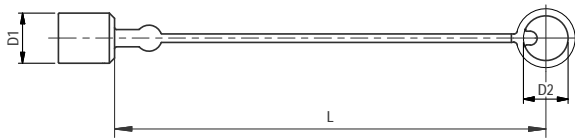

Dimensions (mm/in)			Material	Dust Cap for Male Tip
D1	D2	L		Ordering Codes
11	6	110	Plastic (Colour: Red)	QRC-IA-06-DM-19-KI-RD
.43	.24	4.33		
24	22	220	Plastic (Colour: Red)	QRC-IA-10-DM-22-KI-RD
.93	.87	8.66		
29	26	250	Plastic (Colour: Red)	QRC-IA-12-DM-26-KI-RD
1.14	1.02	9.84		
36,5	36	270	Plastic (Colour: Red)	QRC-IA-19-DM-36-KI-RD
1.44	1.42	10.63		
36	28	235	Plastic (Colour: Red)	QRC-IA-25-DM-28-KI-RD
1.42	1.10	9.25		

Dimensions (mm/in)			Material	Dust Plug for Female Body
D1	D2	L		Ordering Codes
10	6	110	Plastic (Colour: Red)	QRC-IA-06-DF-19-KI-RD
.39	.24	4.33		
28	22	220	Plastic (Colour: Red)	QRC-IA-10-DF-22-KI-RD
1.10	.87	8.66		
35	26	250	Plastic (Colour: Red)	QRC-IA-12-DF-26-KI-RD
1.38	1.02	9.84		
42	36	270	Plastic (Colour: Red)	QRC-IA-19-DF-36-KI-RD
1.65	1.42	10.63		
41	28	235	Plastic (Colour: Red)	QRC-IA-25-DF-28-KI-RD
1.61	1.10	9.25		

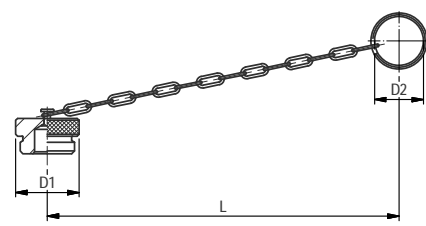
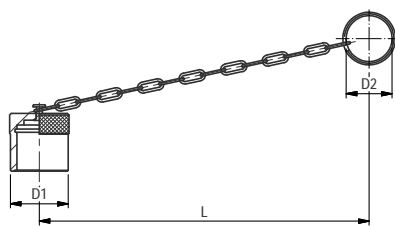

Dimensions (mm/in)			Material	Dust Cap for Male Tip
D1	D2	L		Ordering Codes
19	30	180	Aluminium with chain	QRC-IA-06-DM-30/CN-W89-SI
.75	1.18	7.09		
30	33	200	Aluminium with chain	QRC-IA-10-DM-33/CN-W89-SI
1.18	1.30	7.87		
38	32	205	Aluminium with chain	QRC-IA-12-DM-32/CN-W89-SI
1.50	1.26	8.07		
45	47	275	Aluminium with chain	QRC-IA-19-DM-47/CN-W89-SI
1.77	1.85	10.83		
45	41	290	Aluminium with chain	QRC-IA-25-DM-41/CN-W89-SI
1.77	1.61	11.42		
70	47	275	Aluminium with chain	QRC-IA-31-DM-47/CN-W89-SI
2.76	1.85	10.83		

Dimensions (mm/in)			Material	Dust Plug for Female Body
D1	D2	L		Ordering Codes
19	30	160	Aluminium with chain	QRC-IA-06-DF-30/CN-W89-SI
.75	1.18	6.30		
30	33	200	Aluminium with chain	QRC-IA-10-DF-33/CN-W89-SI
1.18	1.30	7.87		
38	32	205	Aluminium with chain	QRC-IA-12-DF-32/CN-W89-SI
1.50	1.26	8.07		
45	47	275	Aluminium with chain	QRC-IA-19-DF-47/CN-W89-SI
1.77	1.85	10.83		
43	41	240	Aluminium with chain	QRC-IA-25-DF-41/CN-W89-SI
1.69	1.61	9.45		
70	47	275	Aluminium with chain	QRC-IA-31-DF-47/CN-W89-SI
2.76	1.85	10.83		

In addition to the standard colours as stated above, plastic dust caps are also available in blue, green, yellow and black. Please use the color codes BU, GN, YE and BK respectively instead of RD.



Series IA - Stainless Steel

Series IA - Overview	64	Series IA-38 - BG 8 - Nominal Size 38	66
Series IA-06 - BG 1 - Nominal Size 6,3	65	Series IA-51 - BG 9 - Nominal Size 51	66
Series IA-10 - BG 2 - Nominal Size 10	65	Series IA - Dust Protection	67
Series IA-12 - BG 3 - Nominal Size 12,5	65		
Series IA-19 - BG 4 - Nominal Size 19	65		
Series IA-25 - BG 6 - Nominal Size 25	66		
Series IA-31 - BG 7 - Nominal Size 31,5	66		

IA



### Series IA - Stainless Steel

Material	Stainless Steel V4A (AISI 316)
Surface Finishing	-
Standard Seal Material(s)	FKM (Viton®) <sup>2</sup>
Working Temperature	-25° C ... +200° C / -13° F ... +392° F
Valve Design	Poppet Valve
Connection	Push and actuate Push Sleeve
Disconnection	Actuate Push Sleeve
Connect Under Pressure	not allowed
Application	Agricultural and Forestry Machinery, Industrial Hydraulic
ISO Interchange	ISO 7241-1, Series A



<sup>2</sup> Alternative seal materials are available on request.

### Technical Data

Series	BG	DN Zoll Inch	DN metric ISO 4397	Q <sub>max</sub>		Working Pressure		Bursting Pressure Connected		Female Body		Male Tip		Spillage	
				l/min	US GPM	bar	PSI	bar	PSI	bar	PSI	bar	PSI	ml	fl oz
IA-06	1	1/4"	6,3	17	4.49	450	6527	2900	42061	2900	42061	3200	46412	0,5	.0169
IA-10	2	3/8"	10	46	12.15	300	4351	1300	18855	1250	18130	1250	18130	1,9	.0642
IA-12	3	1/2"	12,5	90	23.78	300	4351	1350	19580	1200	17405	1200	17405	2,7	.0913
IA-19	4	3/4"	19 (20)	190	50.19	250	3626	1100	15954	1000	14504	800	11603	9,3	.3145
IA-25	6	1"	25	280	73.97	200	2901	850	12328	650	9427	600	8702	19	.6425
IA-31	7	1 1/4"	31	480	126.80	100	1450	400	5802	400	5802	400	5802	30	10.144
IA-38	8	1 1/2"	38	700	184.92	80	1160	320	4641	320	4641	320	4641	54	18.260
IA-51	9	2"	51	1000	264.17	60	870	250	3626	250	3626	250	3626	120	40.577

The indicated pressure ratings only apply to the coupling itself and depend on the connection type.

### Flow Characteristics

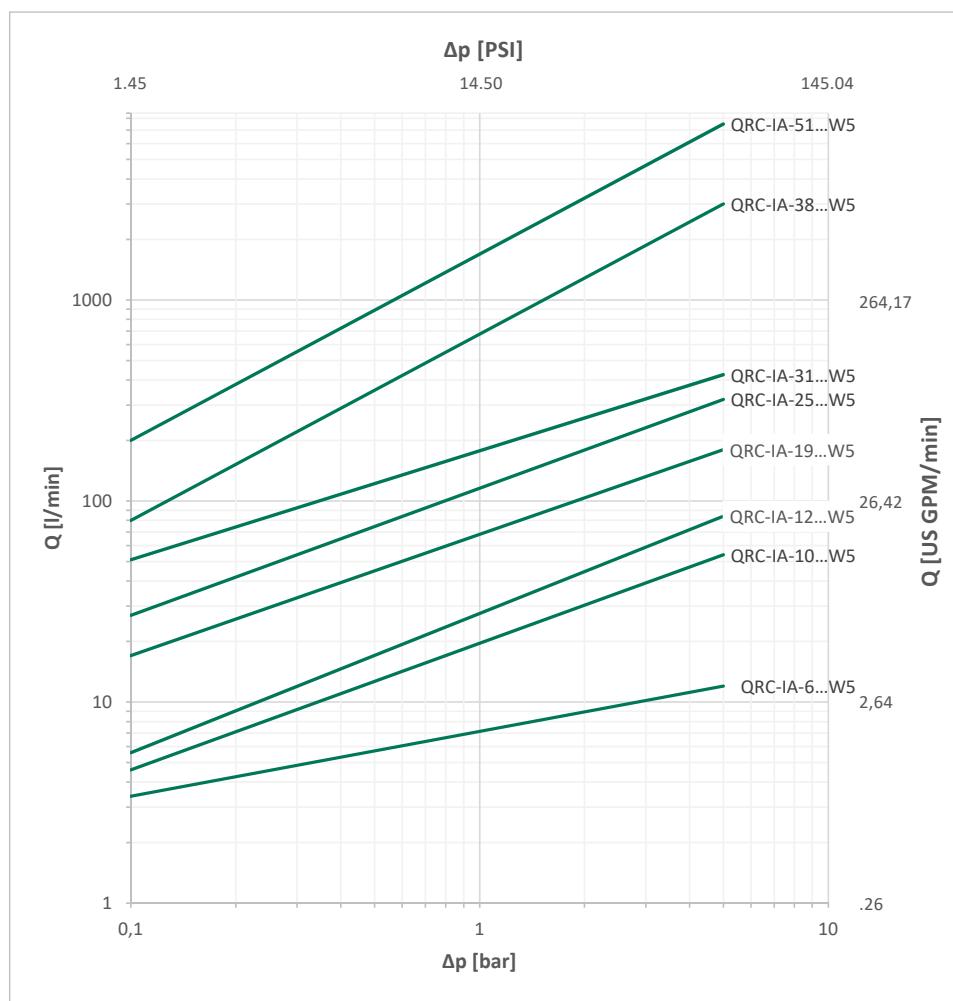

Please note: Unless otherwise stated, all flow characteristics have been determined with hydraulic oil with a kinematic viscosity of 28,8 - 35,2 mm<sup>2</sup>/s (28,8 - 35,2 cSt) and are only valid for components with non-reducing connections.





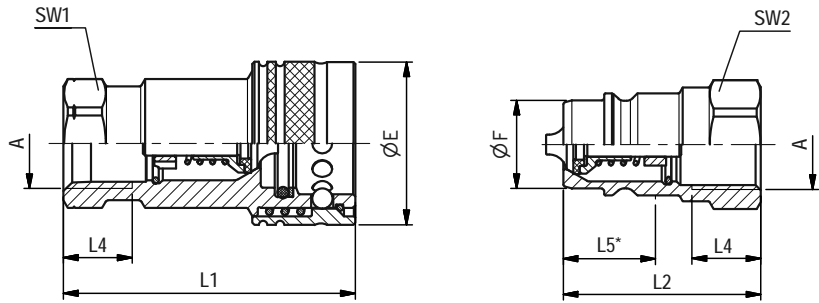

SW: Width across flats. All dimensions in mm (inch). Drawing similar Series IA-12.  
\* Insertion Male Tip.

### Series IA-06 • BG 1 • Nominal Size 6,3

Port A	Dimensions (mm/in)								Female Body Ordering Codes	Weight (kg/lbs) ca. per 100	Male Tip Ordering Codes	Weight (kg/lbs) ca. per 100	
	ØE	ØF	L1	L2	L4 min	L5	SW1	SW2					
Female Thread according to DIN 3852 - ISO 1179-1 - ANSI B. 1.20.3													
	G 1/4"	26	11,85	50,5	35,5	12	14,5	19	19	QRC-IA-06-F-G04-VT-W5	11,90	QRC-IA-06-M-G04-V-W5	3,80
		1.02	.47	1.99	1.40	.47	.57	.75	.75		26.24		8.38
	NPTF 1/4" -18	26	11,85	50,5	35,5		14,5	19	19	QRC-IA-06-F-NF04-VT-W5	12	QRC-IA-06-M-NF04-V-W5	3,90
		1.02	.47	1.99	1.40		.57	.75	.75		26.46		8.60

### Series IA-10 • BG 2 • Nominal Size 10

Port A	Dimensions (mm/in)								Female Body Ordering Codes	Weight (kg/lbs) ca. per 100	Male Tip Ordering Codes	Weight (kg/lbs) ca. per 100	
	ØE	ØF	L1	L2	L4 min	L5	SW1	SW2					
Female Thread according to DIN 3852 - ISO 1179-1 - ANSI B. 1.20.3													
	G 3/8"	30	17,3	58,5	40,5	12	17	22	22	QRC-IA-10-F-G06-VT-W5	15,70	QRC-IA-10-M-G06-V-W5	5,90
		1.18	.68	2.30	1.59	.47	.62	.87	.87		34.61		13.01
	NPTF 3/8" -18	30	17,3	58,5	40,5		17	22	22	QRC-IA-10-F-NF06-VT-W5	15,80	QRC-IA-10-M-NF06-V-W5	6
		1.18	.68	2.30	1.59		.62	.87	.87		34.83		13.23

### Series IA-12 • BG 3 • Nominal Size 12,5

Port A	Dimensions (mm/in)								Female Body Ordering Codes	Weight (kg/lbs) ca. per 100	Male Tip Ordering Codes	Weight (kg/lbs) ca. per 100	
	ØE	ØF	L1	L2	L4 min	L5	SW1	SW2					
Female Thread according to DIN 3852 - ISO 1179-1 - ANSI B. 1.20.3													
	G 1/2"	37,9	20,55	68	46	14	21,5	27	27	QRC-IA-12-F-G08-VT-W5	29,50	QRC-IA-12-M-G08-V-W5	9,70
		1.49	.81	2.68	1.81	.55	.85	1.06	1.06		65.04		21.38
	NPTF 1/2" -14	37,9	20,55	68	46		21,5	27	27	QRC-IA-12-F-NF08-VT-W5	29,70	QRC-IA-12-M-NF08-V-W5	9,90
		1.49	.81	2.68	1.81		.85	1.06	1.06		65.48		21.83

### Series IA-19 • BG 4 • Nominal Size 19

Port A	Dimensions (mm/in)								Female Body Ordering Codes	Weight (kg/lbs) ca. per 100	Male Tip Ordering Codes	Weight (kg/lbs) ca. per 100	
	ØE	ØF	L1	L2	L4 min	L5	SW1	SW2					
Female Thread according to DIN 3852 - ISO 1179-1 - ANSI B. 1.20.3													
	G 3/4"	45	29,1	84,3	57	16	20,8	34	34	QRC-IA-19-F-G12-VT-W5	51	QRC-IA-19-M-G12-V-W5	16,50
		1.77	1.14	84	2.24	.63	.82	1.34	1.34		112.44		36.38
	NPTF 3/4" -14	45	29,1	84,3	57		20,8	34	34	QRC-IA-19-F-NF12-VT-W5	51,30	QRC-IA-19-M-NF12-V-W5	16,80
		1.77	1.14	3.32	2.24		.82	1.34	1.34		113.10		37.04

Note: The connection of the two halves of a coupling is achieved depending on the type. It is important to observe the positive engagement of plug-type couplings and the secure tightening of screw-type couplings to the limit stop of the thread. Forced or improper separation will result in malfunction of the coupling.



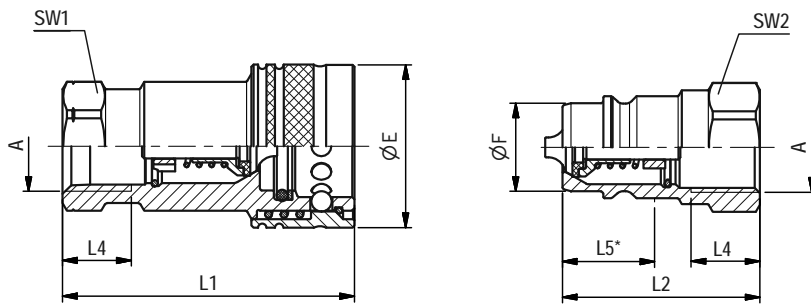

SW: Width across flats. All dimensions in mm (inch). Drawing similar Series IA-12.  
\* Insertion Male Tip.

**Series IA-25 ▪ BG 6 ▪ Nominal Size 25**

Port A	Dimensions (mm/in)								Female Body Ordering Codes	Weight (kg/lbs) ca. per 100	Male Tip Ordering Codes	Weight (kg/lbs) ca. per 100
	ØE	ØF	L1	L2	L4 min	L5	SW1	SW2				
Female Thread according to DIN 3852 - ISO 1179-1 - ANSI B. 1.20.3												
 G 1"	52	34,35	97	63,5	18	33,5	41	41	QRC-IA-25-F-G16-VT-W5	63,60	QRC-IA-25-M-G16-V-W5	28,50
	2,06	1,35	3,82	2,50	,71	1,32	1,61	1,61		140,21		62,83
 NPTF 1" -11 1/2	52	34,35	97	63,5		33,5	41	41	QRC-IA-25-F-NF16-VT-W5	64,30	QRC-IA-25-M-NF16-V-W5	29,20
	2,06	1,35	3,82	2,50		1,32	1,61	1,61		141,76		64,37

**Series IA-31 ▪ BG 7 ▪ Nominal Size 31,5**

Port A	Dimensions (mm/in)								Female Body Ordering Codes	Weight (kg/lbs) ca. per 100	Male Tip Ordering Codes	Weight (kg/lbs) ca. per 100
	ØE	ØF	L1	L2	L4 min	L5	SW1	SW2				
Female Thread according to DIN 3852 - ISO 1179-1 - ANSI B. 1.20.3												
 G 1 1/4"	70	45	115	69	20	34	50	50	QRC-IA-31-F-G20-VT-W5	147	QRC-IA-31-M-G20-V-W5	48
	2,75	1,77	4,53	2,72	,79	1,34	1,97	1,97		324,08		105,82
 NPTF 1 1/4" -11 1/2	70	45	115	69		34	50	50	QRC-IA-31-F-NF20-VT-W5	148,50	QRC-IA-31-M-NF20-V-W5	49,50
	2,75	1,77	4,53	2,72		1,34	1,97	1,97		327,39		109,13

**Series IA-38 ▪ BG 8 ▪ Nominal Size 38**

Port A	Dimensions (mm/in)								Female Body Ordering Codes	Weight (kg/lbs) ca. per 100	Male Tip Ordering Codes	Weight (kg/lbs) ca. per 100
	ØE	ØF	L1	L2	L4 min	L5	SW1	SW2				
Female Thread according to DIN 3852 - ISO 1179-1 - ANSI B. 1.20.3												
 G 1 1/2"	80	55	123	73	22	50	60	60	QRC-IA-38-F-G24-VT-W5	198	QRC-IA-38-M-G24-V-W5	73,80
	3,17	2,16	4,84	2,87	,87	1,97	2,36	2,36		436,52		162,70
 NPTF 1 1/2" -11 1/2	80	55	123	73		50	60	60	QRC-IA-38-F-NF24-VT-W5	202	QRC-IA-38-M-NF24-V-W5	87
	3,17	2,16	4,84	2,87		1,97	2,36	2,36		445,33		191,80

**Series IA-51 ▪ BG 9 ▪ Nominal Size 51**

Port A	Dimensions (mm/in)								Female Body Ordering Codes	Weight (kg/lbs) ca. per 100	Male Tip Ordering Codes	Weight (kg/lbs) ca. per 100
	ØE	ØF	L1	L2	L4 min	L5	SW1	SW2				
Female Thread according to DIN 3852 - ISO 1179-1 - ANSI B. 1.20.3												
 G 2"	102	65,1	147	90	24	57	70	70	QRC-IA-51-F-G32-VT-W5	349	QRC-IA-51-M-G32-V-W5	116,80
	4,01	2,56	5,79	3,54	,94	2,24	2,75	2,75		769,41		257,50
 NPTF 2" -11 1/2	102	65,1	147	90		57	70	70	QRC-IA-51-F-NF32-VT-W5	350	QRC-IA-51-M-NF32-V-W5	117,80
	4,01	2,56	5,79	3,54		2,24	2,75	2,75		771,62		259,70

Note: The connection of the two halves of a coupling is achieved depending on the type. It is important to observe the positive engagement of plug-type couplings and the secure tightening of screw-type couplings to the limit stop of the thread. Forced or improper separation will result in malfunction of the coupling.

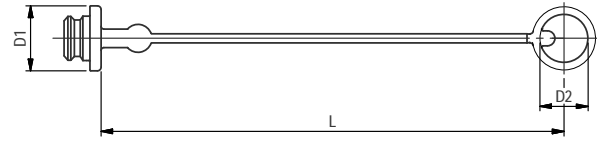
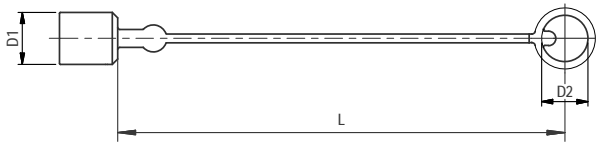

**Series IA - Dust Protection**

Dimensions (mm/in)			Material	Dust Cap for Male Tip
D1	D2	L		Ordering Codes
11	6	110	Plastic (Colour: Red)	QRC-IA-06-DM-19-KI-RD
.43	.24	4.33		
24	22	220	Plastic (Colour: Red)	QRC-IA-10-DM-22-KI-RD
.93	.87	8.66		
29	26	250	Plastic (Colour: Red)	QRC-IA-12-DM-26-KI-RD
1.14	1.02	9.84		
36,5	36	270	Plastic (Colour: Red)	QRC-IA-19-DM-36-KI-RD
1.44	1.42	10.63		
36	28	235	Plastic (Colour: Red)	QRC-IA-25-DM-28-KI-RD
1.42	1.10	9.25		

Dimensions (mm/in)			Material	Dust Plug for Female Body
D1	D2	L		Ordering Codes
10	6	110	Plastic (Colour: Red)	QRC-IA-06-DF-19-KI-RD
.39	.24	4.33		
28	22	220	Plastic (Colour: Red)	QRC-IA-10-DF-22-KI-RD
1.10	.87	8.66		
35	26	250	Plastic (Colour: Red)	QRC-IA-12-DF-26-KI-RD
1.38	1.02	9.84		
42	36	270	Plastic (Colour: Red)	QRC-IA-19-DF-36-KI-RD
1.65	1.42	10.63		
41	28	235	Plastic (Colour: Red)	QRC-IA-25-DF-28-KI-RD
1.61	1.10	9.25		

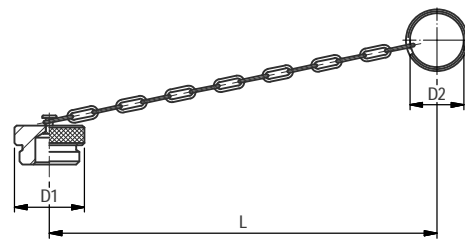
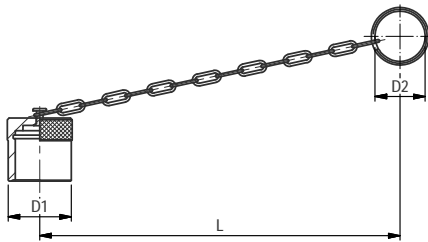

Dimensions (mm/in)			Material	Dust Cap for Male Tip
D1	D2	L		Ordering Codes
19	30	180	Aluminium with chain	QRC-IA-06-DM-30/CN-W89-SI
.75	1.18	7.09		
30	33	200	Aluminium with chain	QRC-IA-10-DM-33/CN-W89-SI
1.18	1.30	7.87		
38	32	205	Aluminium with chain	QRC-IA-12-DM-32/CN-W89-SI
1.50	1.26	8.07		
45	47	275	Aluminium with chain	QRC-IA-19-DM-47/CN-W89-SI
1.77	1.85	10.83		
45	41	290	Aluminium with chain	QRC-IA-25-DM-41/CN-W89-SI
1.77	1.61	11.42		
70	47	275	Aluminium with chain	QRC-IA-31-DM-47/CN-W89-SI
2.76	1.85	10.83		

Dimensions (mm/in)			Material	Dust Plug for Female Body
D1	D2	L		Ordering Codes
19	30	160	Aluminium with chain	QRC-IA-06-DF-30/CN-W89-SI
.75	1.18	6.30		
30	33	200	Aluminium with chain	QRC-IA-10-DF-33/CN-W89-SI
1.18	1.30	7.87		
38	32	205	Aluminium with chain	QRC-IA-12-DF-32/CN-W89-SI
1.50	1.26	8.07		
45	47	275	Aluminium with chain	QRC-IA-19-DF-47/CN-W89-SI
1.77	1.85	10.83		
43	41	240	Aluminium with chain	QRC-IA-25-DF-41/CN-W89-SI
1.69	1.61	9.45		
70	47	275	Aluminium with chain	QRC-IA-31-DF-47/CN-W89-SI
2.76	1.85	10.83		

In addition to the standard colours as stated above, plastic dust caps are also available in blue, green, yellow and black. Please use the color codes BU, GN, YE and BK respectively instead of RD.

**IA**



IA

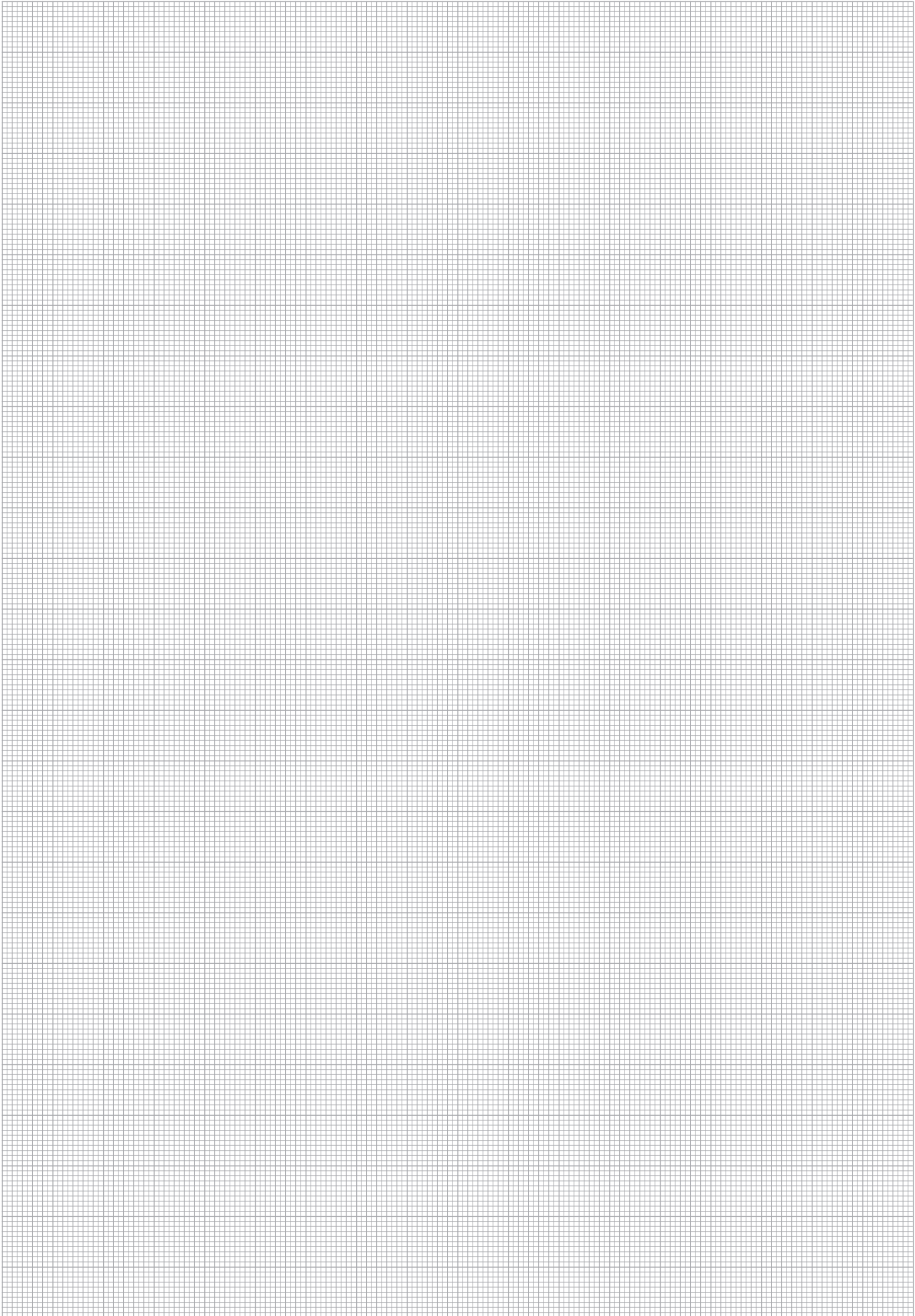

Series IB - Carbon Steel

Series IB - Overview	70	Series IB-38 - BG 8 - Nominal Size 38	73
Series IB-03 - BG 0 - Nominal Size 3,2	71	Series IB-51 - BG 9 - Nominal Size 51	73
Series IB-06 - BG 1 - Nominal Size 6,3	71	Series IB - Dust Protection	74
Series IB-10 - BG 2 - Nominal Size 10	71		
Series IB-12 - BG 3 - Nominal Size 12,5	72		
Series IB-19 - BG 4 - Nominal Size 19	72		
Series IB-25 - BG 6 - Nominal Size 25	72		



Series IB • Carbon Steel

Material	Carbon Steel
Surface Finishing	Zinc-Nickel
Standard Seal Material(s)	NBR (Buna-N®) <sup>2</sup>
Working Temperature	-25° C ... +100° C / -13° F ... +212° F
Valve Design	Poppet Valve
Connection	Push and actuate Push Sleeve
Disconnection	Actuate Push Sleeve
Connect Under Pressure	not allowed
Application	Industrial Hydraulic
ISO Interchange	ISO 7241-1, Series B



<sup>2</sup>Alternative seal materials are available on request.

Technical Data

Series	BG	DN Zoll Inch	DN metric ISO 4397	Q <sub>max</sub>		Working Pressure		Bursting Pressure Connected		Female Body		Male Tip		Spillage	
				l/min	US GPM	bar	PSI	bar	PSI	bar	PSI	bar	PSI	ml	fl oz
IB-03*	0	1/8"	3	9	2.38	500	7252	2700	39160			2400	34809	0,5	.0169
IB-06	1	1/4"	6,3	24	6.34	250	3626	1000	14504	1800	26107	1100	15954	1	.0338
IB-10	2	3/8"	10	46	12.15	250	3626	1300	18855	1400	20305	1400	20305	2,4	.0812
IB-12	3	1/2"	12,5	90	23.78	250	3626	1100	15954	1400	20305	1100	15954	3,9	.1319
IB-19	4	3/4"	19 (20)	220	58.12	220	3191	1000	14504	900	13053	1000	14504	11	.3720
IB-25	6	1"	25	260	68.68	200	2901							19	.6425
IB-38	8	1 1/2"	38	757	199.98									95	32.123
IB-51	9	2"	51	1000	264.17									170	57.484

The indicated pressure ratings only apply to the coupling itself and depend on the connection type.

\* Up to DN 25 complies DN 5 acc. to ISO 7241-1, Series B

Flow Characteristics

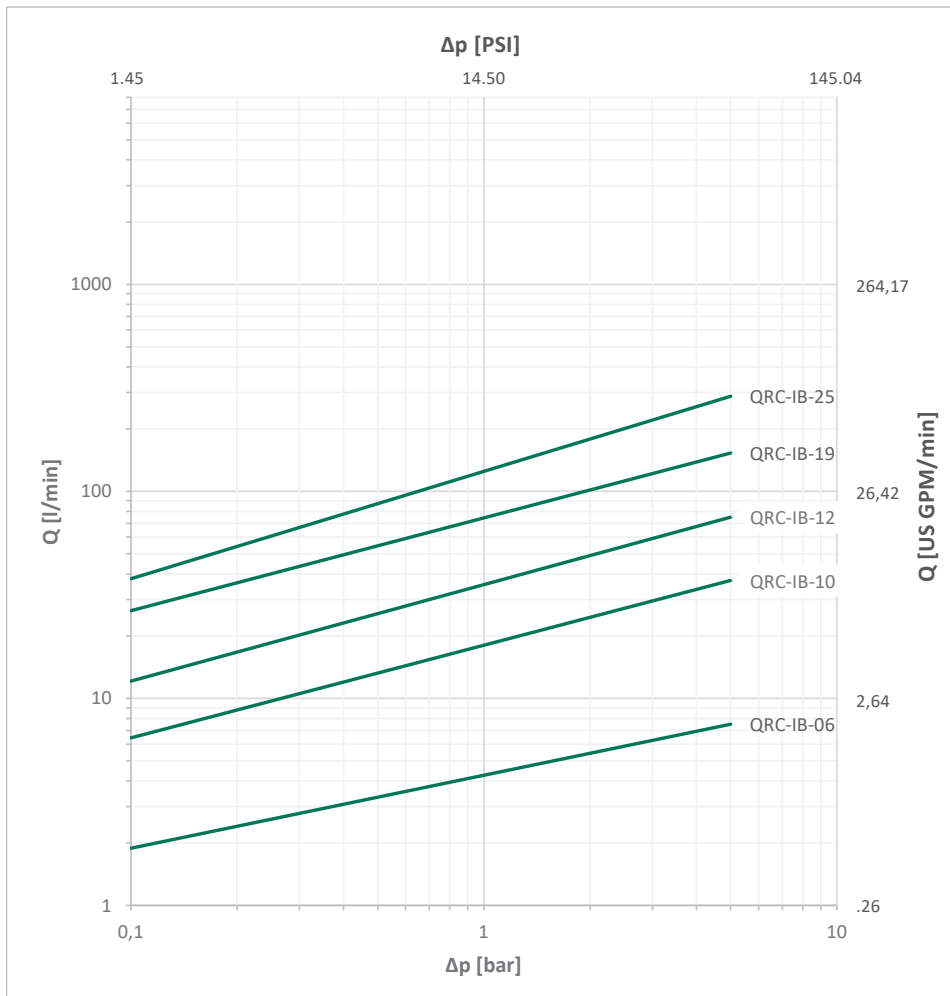

Please note: Unless otherwise stated, all flow characteristics have been determined with hydraulic oil with a kinematic viscosity of 28,8 - 35,2 mm<sup>2</sup>/s (28,8 - 35,2 cSt) and are only valid for components with non-reducing connections.



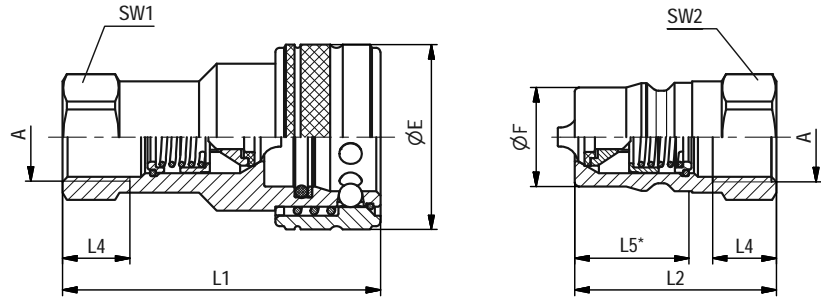

SW: Width across flats. All dimensions in mm (inch). Drawing similar Series IB-12.  
\* Insertion Male Tip.

### Series IB-03 • BG 0 • Nominal Size 3,2

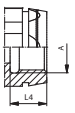
Port A	Dimensions ( <sup>mm</sup> / <sub>in</sub> )							Female Body		Weight ( <sup>kg</sup> / <sub>lbs</sub> ) ca. per 100	Male Tip		Weight ( <sup>kg</sup> / <sub>lbs</sub> ) ca. per 100
	ØE	ØF	L1	L2	L4 min	L5	SW1	SW2	Ordering Codes		Ordering Codes		
Female Thread according to ANSI B 1.20.3													
	NPTF 1/8" -27	24	10,9	103	29		17	14	QRC-IB-03-F-NF02-BT-W3	8,90 19.62	QRC-IB-03-M-NF02-B-W3	2 4.41	
		.94	.43	4.06	1.14		.67	.55					

### Series IB-06 • BG 1 • Nominal Size 6,3

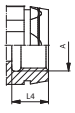
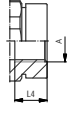
Port A	Dimensions ( <sup>mm</sup> / <sub>in</sub> )							Female Body		Weight ( <sup>kg</sup> / <sub>lbs</sub> ) ca. per 100	Male Tip		Weight ( <sup>kg</sup> / <sub>lbs</sub> ) ca. per 100
	ØE	ØF	L1	L2	L4 min	L5	SW1	SW2	Ordering Codes		Ordering Codes		
Female Thread according to DIN 3852 - ISO 1179-1 - ANSI B 1.20.3													
	G 1/4"	28,5	14,2	58	36	13	21,8	19	19	QRC-IB-06-F-G04-BT-W3	12,60 27.78	QRC-IB-06-M-G04-B-W3	3,56 7.85
		1.12	.56	2.28	1.42	.51	.86	.75	.75				
	NPTF 1/4" -18	28,5	14,2	58	36		21,8	19	19	QRC-IB-06-F-NF04-BT-W3	12,91 28.46	QRC-IB-06-M-NF04-B-W3	3,00 6.61
		1.12	.56	2.28	1.42		.86	.75	.75				
Female Thread according to SAE J 1926-1													
	UNF 9/16" -18	28,5	14,2	58	36	13	21,8	19	19	QRC-IB-06-F-U06-BT-W3	12,60 27.78	QRC-IB-06-M-U06-B-W3	3,56 7.85
		1.12	.56	2.28	1.42	.51	.86	.75	.75				

### Series IB-10 • BG 2 • Nominal Size 10

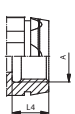
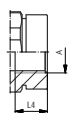
Port A	Dimensions ( <sup>mm</sup> / <sub>in</sub> )							Female Body		Weight ( <sup>kg</sup> / <sub>lbs</sub> ) ca. per 100	Male Tip		Weight ( <sup>kg</sup> / <sub>lbs</sub> ) ca. per 100
	ØE	ØF	L1	L2	L4 min	L5	SW1	SW2	Ordering Codes		Ordering Codes		
Female Thread according to DIN 3852 - ISO 1179-1 - ANSI B 1.20.3													
	G 3/8"	35	19	65	40	13	24,7	24	24	QRC-IB-10-F-G06-BT-W3	22,30 49.16	QRC-IB-10-M-G06-B-W3	6,67 14.70
		1.38	7.48	2.56	1.57	.51	.97	.94	.94				
	NPTF 3/8" -18	35	19	65	40		24,7	24	24	QRC-IB-10-F-NF06-BT-W3	21,73 47.91	QRC-IB-10-M-NF06-B-W3	6,76 14.93
		1.38	7.48	2.56	1.57		.97	.94	.94				
Female Thread according to SAE J 1926-1													
	UNF 3/4" -16	35	19	65	40	14,3	24,7	24	24	QRC-IB-10-F-U08-BT-W3	22,30 49.16	QRC-IB-10-M-U08-B-W3	6,67 14.70
		1.38	7.48	2.56	1.57	.56	.97	.94	.94				



Note: The connection of the two halves of a coupling is achieved depending on the type. It is important to observe the positive engagement of plug-type couplings and the secure tightening of screw-type couplings to the limit stop of the thread. Forced or improper separation will result in malfunction of the coupling.

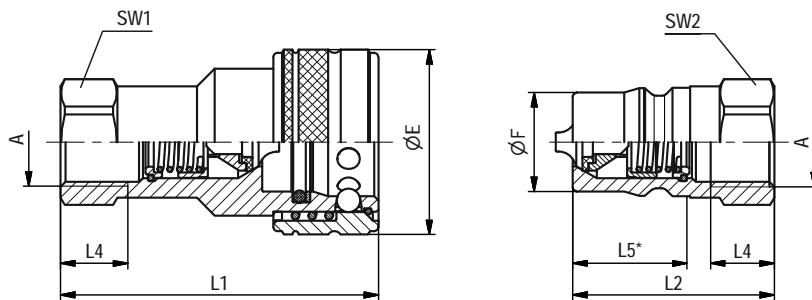



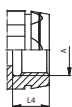

SW: Width across flats. All dimensions in mm (inch). Drawing similar Series IB-12.  
\* Insertion Male Tip.

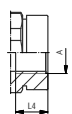

**Series IB-12 • BG 3 • Nominal Size 12,5**

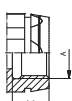
Port A	Dimensions (mm/in)								Female Body Ordering Codes	Weight (kg/lbs) ca. per 100	Male Tip Ordering Codes	Weight (kg/lbs) ca. per 100
	ØE	ØF	L1	L2	L4 min	L5	SW1	SW2				
Female Thread according to DIN 3852 - ISO 1179-1 - ANSI B 1.20.3												
 G 1/2"	44,5	23,55	74	46,5	20,5	27,2	28,5	28,5	QRC-IB-12-F-G08-BT-W3	36,40	QRC-IB-12-M-G08-B-W3	12,3
	1,75	.93	2,91	1,83	8,07	1,07	1,12	1,12		80,25		27,12
 NPTF 1/2" -14	44,5	23,55	74	46,5		27,2	28,5	28,5	QRC-IB-12-F-NF08-BT-W3	36,64	QRC-IB-12-M-NF08-B-W3	11,49
	1,75	.93	2,91	1,83		1,07	1,12	1,12		80,78		25,33
Female Thread according to SAE J 1926-1												
 UNF 7/8" -14	44,5	23,55	74	46,5	16,7	27,2	28,5	28,5	QRC-IB-12-F-U10-BT-W3	36,40	QRC-IB-12-M-U10-B-W3	12,3
	1,75	.93	2,91	1,83	.66	1,07	1,12	1,12		80,25		27,12

**Series IB-19 • BG 4 • Nominal Size 19**

Port A	Dimensions (mm/in)								Female Body Ordering Codes	Weight (kg/lbs) ca. per 100	Male Tip Ordering Codes	Weight (kg/lbs) ca. per 100
	ØE	ØF	L1	L2	L4 min	L5	SW1	SW2				
Female Thread according to DIN 3852 - ISO 1179-1 - ANSI B.1.20.3												
 G 3/4"	54	31,5	92	56	22	35,4	36	36	QRC-IB-19-F-G12-BT-W3	68,2	QRC-IB-19-M-G12-B-W3	24,40
	2,13	1,24	3,62	2,20	.87	1,39	1,42	1,42		150,36		53,79
 NPTF 3/4" -14	54	31,5	92	56		35,4	36	36	QRC-IB-19-F-NF12-BT-W3	65,80	QRC-IB-19-M-NF12-B-W3	22,36
	2,13	1,24	3,62	2,20		1,39	1,42	1,42		145,06		49,30

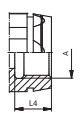
**Series IB-25 • BG 6 • Nominal Size 25**

Port A	Dimensions (mm/in)								Female Body Ordering Codes	Weight (kg/lbs) ca. per 100	Male Tip Ordering Codes	Weight (kg/lbs) ca. per 100
	ØE	ØF	L1	L2	L4 min	L5	SW1	SW2				
Female Thread according to DIN 3852 - ISO 1179-1 - ANSI B.1.20.3												
 G 1"	63,5	37,8	103	63	23		41	41	QRC-IB-25-F-G16-BT-W3	99,90	QRC-IB-25-M-G16-B-W3	33,10
	2,5	1,49	4,06	2,48	.91		1,61	1,61		220,24		72,97
 NPTF 1" -11 1/2	63,5	37,8	103	63	23		41	41	QRC-IB-25-F-NF16-BT-W3	99,90	QRC-IB-25-M-NF16-B-W3	33,10
	2,5	1,49	4,06	2,48	.91		1,61	1,61		220,24		72,97

Note: The connection of the two halves of a coupling is achieved depending on the type. It is important to observe the positive engagement of plug-type couplings and the secure tightening of screw-type couplings to the limit stop of the thread. Forced or improper separation will result in malfunction of the coupling.





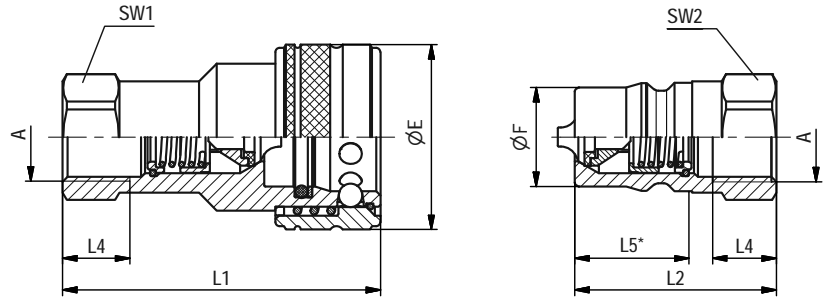

SW: Width across flats. All dimensions in mm (inch). Drawing similar Series IB-12.  
\* Insertion Male Tip.

### Series IB-38 • BG 8 • Nominal Size 38

Port A	Dimensions ( <sup>mm</sup> / <sub>in</sub> )							Female Body		Weight ( <sup>kg</sup> / <sub>lbs</sub> ) ca. per 100	Male Tip		Weight ( <sup>kg</sup> / <sub>lbs</sub> ) ca. per 100
	ØE	ØF	L1	L2	L4 min	L5	SW1	SW2	Ordering Codes		Ordering Codes		
Female Thread according to DIN 3852 - ISO 1179-1 - ANSI B.1.20.3													
	G 1 1/4"	73,5		124	122			60	60	QRC-IB-38-F-G20-BT-W3	200,80 442.69	QRC-IB-38-M-G20-B-W3	135,50 298.73
	NPTF 1 1/4" -11 1/2	73,5		124	122			60	60	QRC-IB-38-F-NF20-BT-W3	202,00 445.33	QRC-IB-38-M-NF20-B-W3	136,80 301.59

### Series IB-51 • BG 9 • Nominal Size 51

Port A	Dimensions ( <sup>mm</sup> / <sub>in</sub> )							Female Body		Weight ( <sup>kg</sup> / <sub>lbs</sub> ) ca. per 100	Male Tip		Weight ( <sup>kg</sup> / <sub>lbs</sub> ) ca. per 100
	ØE	ØF	L1	L2	L4 min	L5	SW1	SW2	Ordering Codes		Ordering Codes		
Female Thread according to DIN 3852 - ISO 1179-1 - ANSI B.1.20.3													
	G 2"	101		141,5	139,5			95	95	QRC-IB-51-F-G32-BT-W3	490 1080.27	QRC-IB-51-M-G32-B-W3	310 683.43
	NPTF 2" -11 1/2	101		141,5	139,5			95	95	QRC-IB-51-F-NF32-BT-W3	500 1102.31	QRC-IB-51-M-NF32-B-W3	320 705.48



Series IB - Dust Protection

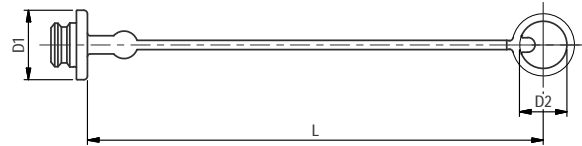
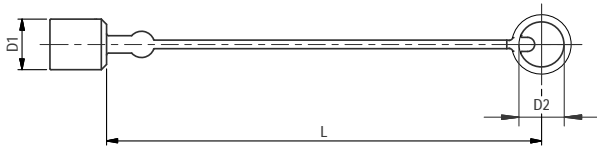

Dimensions (mm/in)			Material	Dust Cap for Male Tip
D1	D2	L		Ordering Codes
18	23	240	Plastic (Colour: Red)	QRC-IB-06-DM-23-KI-RD
.71	.91	9.45		
23	24	240	Plastic (Colour: Red)	QRC-IB-10-DM-24-KI-RD
.91	.94	9.45		
29	28	245	Plastic (Colour: Red)	QRC-IB-12-DM-28-KI-RD
1.14	1.10	9.65		
36,0	38	245	Plastic (Colour: Red)	QRC-IB-19-DM-38-KI-RD
1.42	1.50	9.65		
44	46	253	Plastic (Colour: Red)	QRC-IB-25-DM-46-KI-RD
1.73	1.81	9.96		

Dimensions (mm/in)			Material	Dust Plug for Female Body
D1	D2	L		Ordering Codes
26	23	240	Plastic (Colour: Red)	QRC-IB-06-DF-23-KI-RD
1.02	.91	9.45		
33	24	235	Plastic (Colour: Red)	QRC-IB-10-DF-24-KI-RD
1.30	.94	9.25		
38	28	240	Plastic (Colour: Red)	QRC-IB-12-DF-28-KI-RD
1.50	1.10	9.45		
49	38	240	Plastic (Colour: Red)	QRC-IB-19-DF-38-KI-RD
1.93	1.50	9.45		
60	46	245	Plastic (Colour: Red)	QRC-IB-25-DF-46-KI-RD
2.36	1.81	9.65		

IB

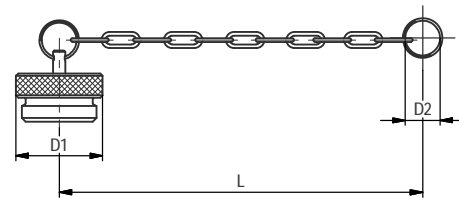
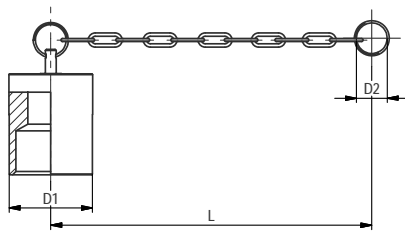

Dimensions (mm/in)			Material	Dust Cap for Male Tip
D1	D2	L		Ordering Codes
22	28	245	Aluminium with chain	QRC-IB-06-DM-28/CN-W89-SI
.87	1.10	9.65		
27	30	155	Aluminium with chain	QRC-IB-10-DM-30/CN-W89-SI
1.06	1.18	6.10		
35	41	265	Aluminium with chain	QRC-IB-12-DM-41/CN-W89-SI
1.38	1.61	10.43		
42	30	250	Aluminium with chain	QRC-IB-19-DM-30/CN-W89-SI
1.65	1.18	9.84		
48	49	340	Aluminium with chain	QRC-IB-25-DM-49/CN-W89-SI
1.89	1.93	13.39		
55	46	225	Aluminium with chain	QRC-IB-38-DM-46/CN-W89-SI
2.17	1.81	8.86		
80	75	350	Aluminium with chain	QRC-IB-51-DM-75/CN-W89-SI
3.15	2.95	13.78		

Dimensions (mm/in)			Material	Dust Plug for Female Body
D1	D2	L		Ordering Codes
22	30	210	Aluminium with chain	QRC-IB-06-DF-30/CN-W89-SI
.87	1.18	8.27		
22	30	155	Aluminium with chain	QRC-IB-10-DF-30/CN-W89-SI
.87	1.18	6.10		
28	41	305	Aluminium with chain	QRC-IB-12-DF-41/CN-W89-SI
1.10	1.61	12.01		
35	43	265	Aluminium with chain	QRC-IB-19-DF-43/CN-W89-SI
1.38	1.69	10.43		
44	41	240	Aluminium with chain	QRC-IB-25-DF-41/CN-W89-SI
1.73	1.61	9.45		
74	46	225	Aluminium with chain	QRC-IB-38-DF-46/CN-W89-SI
2.91	1.81	8.86		
105	75	350	Aluminium with chain	QRC-IB-51-DF-75/CN-W89-SI
4.13	2.95	13.78		

In addition to the standard colours as stated above, plastic dust caps are also available in blue, green, yellow and black. Please use the color codes BU, GN, YE and BK respectively instead of RD.



Series IB • Brass

Series IB • Overview	76	Series IB-51 • BG 9 • Nominal Size 51	78
Series IB-06 • BG 1 • Nominal Size 6,3	77	Series IB • Dust Protection	79
Series IB-10 • BG 2 • Nominal Size 10	77		
Series IB-12 • BG 3 • Nominal Size 12,5	77		
Series IB-19 • BG 4 • Nominal Size 19	77		
Series IB-25 • BG 6 • Nominal Size 25	78		
Series IB-38 • BG 8 • Nominal Size 38	78		



IB



Series IB • Brass

Material	Brass
Surface Finishing	-
Standard Seal Material(s)	FKM (Viton®) <sup>2</sup>
Working Temperature	-25° C ... +200° C / -13° F ... +392° F
Valve Design	Poppet Valve
Connection	Push and actuate Push Sleeve
Disconnection	Actuate Push Sleeve
Connect Under Pressure	not allowed
Application	Industrial Hydraulic
ISO Interchange	Up to DN 25 according to ISO 7241-1, Series B



<sup>2</sup>Alternative seal materials are available on request.

Technical Data

Series	BG	DN Zoll Inch	DN metric ISO 4397	Q <sub>max</sub>		Working Pressure		Bursting Pressure Connected		Female Body		Male Tip		Spillage	
				l/min	US GPM	bar	PSI	bar	PSI	bar	PSI	bar	PSI	ml	fl oz
IB-06	1	1/4"	6,3	24	6.34	200	2901							1	.0338
IB-10	2	3/8"	10	46	12.15	200	2901							2,4	.0812
IB-12	3	1/2"	12,5	90	23.78	180	2611	1000	14504			720	10443	3,9	.1319
IB-19	4	3/4"	19 (20)	220	58.12	130	1885					550	7977	11	.3720
IB-25	6	1"	25	260	68.68	130	1885	600	8702					19	.6425
IB-38	8	1 1/2"	38	757	199.98	60	870							95	32.123
IB-51	9	2"	51	1000	264.17	50	725							170	57.484

The indicated pressure ratings only apply to the coupling itself and depend on the connection type.

Flow Characteristics

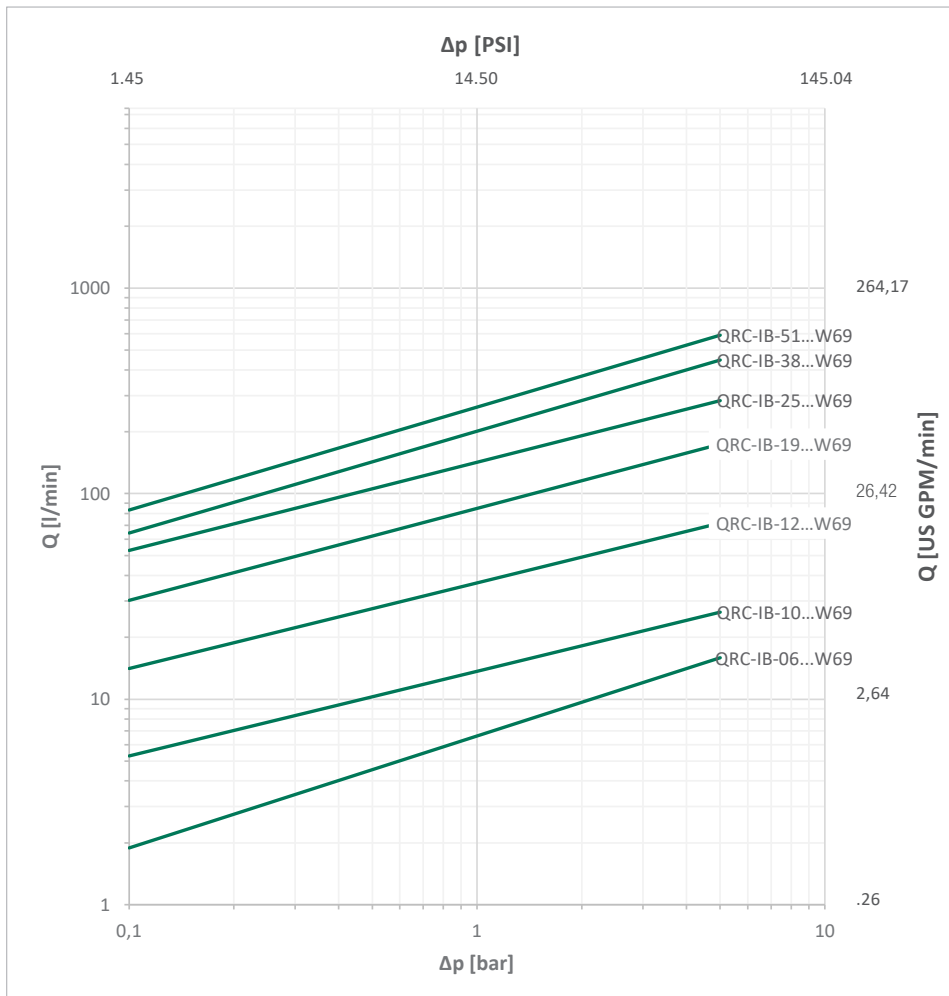

Please note: Unless otherwise stated, all flow characteristics have been determined with hydraulic oil with a kinematic viscosity of 28,8 - 35,2 mm<sup>2</sup>/s (28,8 - 35,2 cSt) and are only valid for components with non-reducing connections.



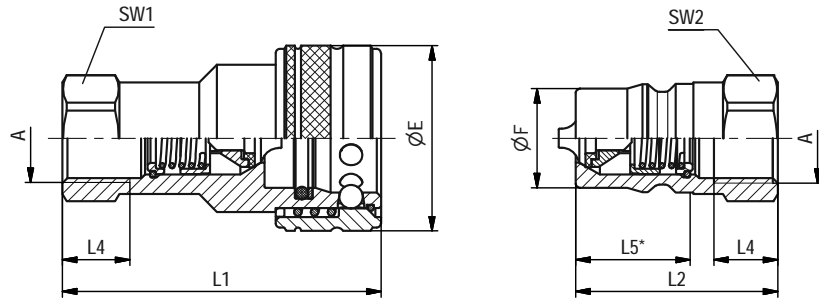

SW: Width across flats. All dimensions in mm (inch). Drawing similar Series IB-12.  
\* Insertion Male Tip.

### Series IB-06 ▪ BG 1 ▪ Nominal Size 6,3

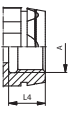
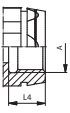
Port A	Dimensions (mm/in)								Female Body Ordering Codes	Weight (kg/lbs) ca. per 100	Male Tip Ordering Codes	Weight (kg/lbs) ca. per 100	
	ØE	ØF	L1	L2	L4	L5	SW1	SW2					
Female Thread according to DIN 3852 - ISO 1179-1 - ANSI B 1.20.3													
	G 1/4"	27	14,2	58	36	12,5	21,8	19	17	QRC-IB-06-F-G04-VT-W69	13,30	QRC-IB-06-M-G04-V-W69	4,30
		1.06	.56	2.28	1.42	.49	.86	.75	.67		29.32		9.48
	NPTF 1/4" -18	27	14,2	58	36		21,8	19	17	QRC-IB-06-F-NF04-VT-W69	13,40	QRC-IB-06-M-NF04-V-W69	4,40
		1.06	.56	2.28	1.42		.86	.75	.67		29.54		9.70

### Series IB-10 ▪ BG 2 ▪ Nominal Size 10

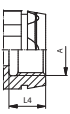
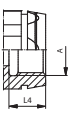
Port A	Dimensions (mm/in)								Female Body Ordering Codes	Weight (kg/lbs) ca. per 100	Male Tip Ordering Codes	Weight (kg/lbs) ca. per 100	
	ØE	ØF	L1	L2	L4	L5	SW1	SW2					
Female Thread according to DIN 3852 - ISO 1179-1 - ANSI B 1.20.3													
	G 3/8"	35	19	65	40	13	24,7	22	22	QRC-IB-10-F-G06-VT-W69	19,31	QRC-IB-10-M-G06-V-W69	6,90
		1.38	.75	2.56	1.57	.51	9.72	.87	.87		42.57		15.21
	NPTF 3/8" -18	35	19	65	40		24,7	22	22	QRC-IB-10-F-NF06-VT-W69	21,50	QRC-IB-10-M-NF06-V-W69	7,10
		1.38	.75	2.56	1.57		9.72	.87	.87		47.40		15.65

### Series IB-12 ▪ BG 3 ▪ Nominal Size 12,5

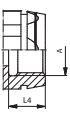
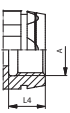
Port A	Dimensions (mm/in)								Female Body Ordering Codes	Weight (kg/lbs) ca. per 100	Male Tip Ordering Codes	Weight (kg/lbs) ca. per 100	
	ØE	ØF	L1	L2	L4	L5	SW1	SW2					
Female Thread according to DIN 3852 - ISO 1179-1 - ANSI B 1.20.3													
	G 1/2"	45	23,55		44	16	27,2	29	27	QRC-IB-12-F-G08-VT-W69	35,97	QRC-IB-12-M-G08-V-W69	10,48
		1.77	.93		1.73	.63	1.07	1.14	1.06		79.30		23.10
	NPTF 1/2" -14	45	23,55		44	16	27,2	29	27	QRC-IB-12-F-NF08-VT-W69	40	QRC-IB-12-M-NF08-V-W69	12,80
		1.77	.93		1.73	.63	1.07	1.14	1.06		88.18		28.22

### Series IB-19 ▪ BG 4 ▪ Nominal Size 19

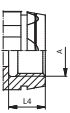
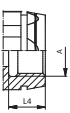
Port A	Dimensions (mm/in)								Female Body Ordering Codes	Weight (kg/lbs) ca. per 100	Male Tip Ordering Codes	Weight (kg/lbs) ca. per 100	
	ØE	ØF	L1	L2	L4	L5	SW1	SW2					
Female Thread according to DIN 3852 - ISO 1179-1 - ANSI B 1.20.3													
	G 3/4"	54	31,4	88	52	17	35,4	36	36	QRC-IB-19-F-G12-VT-W69	64,10	QRC-IB-19-M-G12-V-W69	22,18
		2.13	1.24	3.46	2.05	.67	1.39	1.42	1.42		141.32		49.90
	NPTF 3/4" -14	54	31,4	88	52		35,4	36	36	QRC-IB-19-F-NF12-VT-W69	60,10	QRC-IB-19-M-NF12-V-W69	23
		2.13	1.24	3.46	2.05		1.39	1.42	1.42		132.50		50.71

Note: The connection of the two halves of a coupling is achieved depending on the type. It is important to observe the positive engagement of plug-type couplings and the secure tightening of screw-type couplings to the limit stop of the thread. Forced or improper separation will result in malfunction of the coupling.



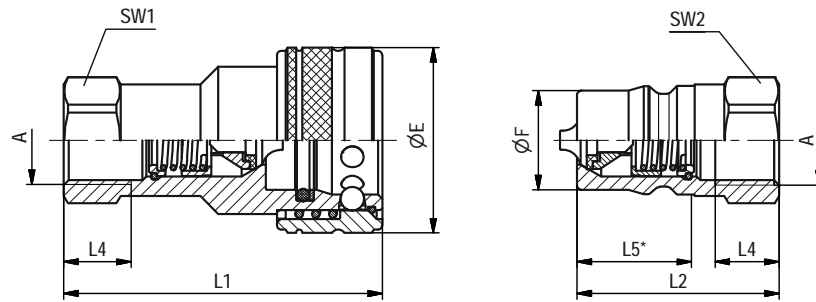

SW: Width across flats. All dimensions in mm (inch). Drawing similar Series IB-12.  
\* Insertion Male Tip.

### Series IB-25 ▪ BG 6 ▪ Nominal Size 25

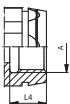
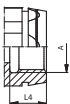
Port A	Dimensions (mm/in)							Female Body		Weight ( <sup>kg</sup> /lbs) ca. per 100	Male Tip		Weight ( <sup>kg</sup> /lbs) ca. per 100
	ØE	ØF	L1	L2	L4 min	L5	SW1	SW2	Ordering Codes		Ordering Codes		
Female Thread according to DIN 3852 - ISO 1179-1 - ANSI B 1.20.3													
 G 1"	64,5	37,8	102	62	23		41	41	QRC-IB-25-F-G16-VT-W69	93,80	QRC-IB-25-M-G16-V-W69	39,20	
	2,54	1,49	4,02	2,44	.91		1,61	1,61		206,79		86,42	
 NPTF 1" -11 1/2	64,5	37,8	102	62			41	41	QRC-IB-25-F-NF16-VT-W69	95	QRC-IB-25-M-NF16-V-W69	40,30	
	2,54	1,49	4,02	2,44			1,61	1,61		209,44		88,85	

### Series IB-38 ▪ BG 8 ▪ Nominal Size 38

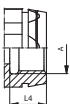
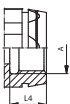
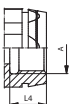
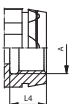
Port A	Dimensions (mm/in)							Female Body		Weight ( <sup>kg</sup> /lbs) ca. per 100	Male Tip		Weight ( <sup>kg</sup> /lbs) ca. per 100
	ØE	ØF	L1	L2	L4 min	L5	SW1	SW2	Ordering Codes		Ordering Codes		
Female Thread according to DIN 3852 - ISO 1179-1 - ANSI B 1.20.3													
 G 1 1/4"	79	50	124	75	27		60	60	QRC-IB-38-F-G20-VT-W69	219,80	QRC-IB-38-M-G20-V-W69	145,20	
	3,11	1,97	4,88	2,95	1,06		2,36	2,36		484,58		320,11	
 NPTF 1 1/4" -11 1/2	79	50	124	75			60	60	QRC-IB-38-F-NF20-VT-W69	217	QRC-IB-38-M-NF20-V-W69	146,90	
	3,11	1,97	4,88	2,95			2,36	2,36		478,40		323,87	
 G 1 1/2"	79	50	124	75	27		60	60	QRC-IB-38-F-G24-VT-W69	212,60	QRC-IB-38-M-G24-V-W69	137,10	
	3,11	1,97	4,88	2,95	1,07		2,36	2,36		468,70		302,25	
 NPTF 1 1/2" -11 1/2	79	50	124	75			60	60	QRC-IB-38-F-NF24-VT-W69	214,80	QRC-IB-38-M-NF24-V-W69	139	
	3,11	1,97	4,88	2,95			2,36	2,36		473,55		306,44	

### Series IB-51 ▪ BG 9 ▪ Nominal Size 51

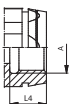
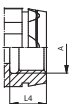
Port A	Dimensions (mm/in)							Female Body		Weight ( <sup>kg</sup> /lbs) ca. per 100	Male Tip		Weight ( <sup>kg</sup> /lbs) ca. per 100
	ØE	ØF	L1	L2	L4 min	L5	SW1	SW2	Ordering Codes		Ordering Codes		
Female Thread according to DIN 3852 - ISO 1179-1 - ANSI B 1.20.3													
 G 2"	102	70	132	80	30		77	77	QRC-IB-51-F-G32-VT-W69	532	QRC-IB-51-M-G32-V-W69	347	
	4,02	2,76	5,20	3,15	1,18		3,03	3,03		1172,86		765	
 NPTF 2" -11 1/2	102	70	132	80			77	77	QRC-IB-51-F-NF32-VT-W69	537	QRC-IB-51-M-NF32-V-W69	352	
	4,02	2,76	5,20	3,15			3,03	3,03		1183,88		776,03	

Note: The connection of the two halves of a coupling is achieved depending on the type. It is important to observe the positive engagement of plug-type couplings and the secure tightening of screw-type couplings to the limit stop of the thread. Forced or improper separation will result in malfunction of the coupling.

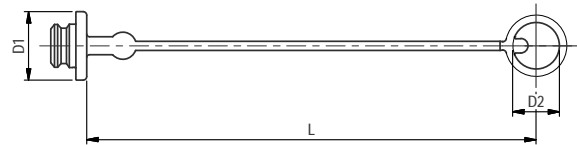
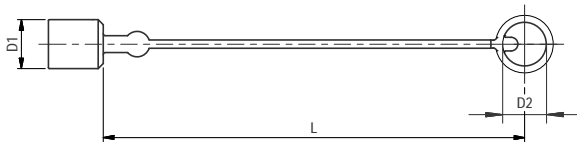

**Series IB • Dust Protection**

Dimensions (mm/in)			Material	Dust Cap for Male Tip
D1	D2	L		Ordering Codes
18	23	240	Plastic (Colour: Red)	QRC-IB-06-DM-23-KI-RD
.71	.91	9.45		
23	24	240	Plastic (Colour: Red)	QRC-IB-10-DM-24-KI-RD
.91	.94	9.45		
29	28	245	Plastic (Colour: Red)	QRC-IB-12-DM-28-KI-RD
1.14	1.10	9.65		
36,0	38	245	Plastic (Colour: Red)	QRC-IB-19-DM-38-KI-RD
1.42	1.50	9.65		
44	44	253	Plastic (Colour: Red)	QRC-IB-25-DM-44-KI-RD
1.73	1.73	9.96		

Dimensions (mm/in)			Material	Dust Plug for Female Body
D1	D2	L		Ordering Codes
26	23	240	Plastic (Colour: Red)	QRC-IB-06-DF-23-KI-RD
1.02	.91	9.45		
33	25	235	Plastic (Colour: Red)	QRC-IB-10-DF-25-KI-RD
1.30	.98	9.25		
38	29	240	Plastic (Colour: Red)	QRC-IB-12-DF-29-KI-RD
1.50	1.14	9.45		
49	38	240	Plastic (Colour: Red)	QRC-IB-19-DF-38-KI-RD
1.93	1.50	9.45		
60	46	245	Plastic (Colour: Red)	QRC-IB-25-DF-46-KI-RD
2.36	1.81	9.65		

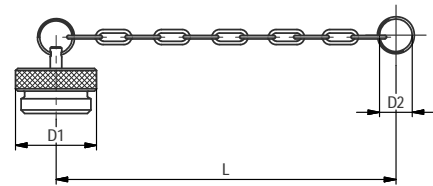
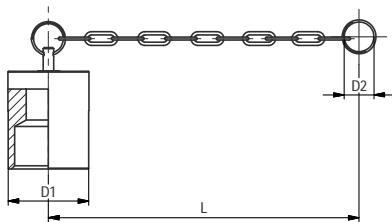

Dimensions (mm/in)			Material	Dust Cap for Male Tip
D1	D2	L		Ordering Codes
22	28	245	Aluminium with chain	QRC-IB-06-DM-28/CN-W89-SI
.87	1.10	9.65		
27	30	155	Aluminium with chain	QRC-IB-10-DM-30/CN-W89-SI
1.06	1.18	6.10		
35	41	265	Aluminium with chain	QRC-IB-12-DM-41/CN-W89-SI
1.38	1.61	10.43		
42	30	250	Aluminium with chain	QRC-IB-19-DM-30/CN-W89-SI
1.65	1.18	9.84		
48	49	340	Aluminium with chain	QRC-IB-25-DM-49/CN-W89-SI
1.89	1.93	13.39		
55	46	225	Aluminium with chain	QRC-IB-38-DM-46/CN-W89-SI
2.17	1.81	8.86		
80	75	350	Aluminium with chain	QRC-IB-51-DM-75/CN-W89-SI
3.15	2.95	13.78		

Dimensions (mm/in)			Material	Dust Plug for Female Body
D1	D2	L		Ordering Codes
22	30	210	Aluminium with chain	QRC-IB-06-DF-30/CN-W89-SI
.87	1.18	8.27		
22	30	155	Aluminium with chain	QRC-IB-10-DF-30/CN-W89-SI
.87	1.18	6.10		
28	41	305	Aluminium with chain	QRC-IB-12-DF-41/CN-W89-SI
1.10	1.61	12.01		
35	43	265	Aluminium with chain	QRC-IB-19-DF-43/CN-W89-SI
1.38	1.69	10.43		
44	41	240	Aluminium with chain	QRC-IB-25-DF-41/CN-W89-SI
1.73	1.61	9.45		
74	46	225	Aluminium with chain	QRC-IB-38-DF-46/CN-W89-SI
2.91	1.81	8.86		
105	75	350	Aluminium with chain	QRC-IB-51-DF-75/CN-W89-SI
4.13	2.95	13.78		

In addition to the standard colours as stated above, plastic dust caps are also available in blue, green, yellow and black. Please use the color codes BU, GN, YE and BK respectively instead of RD.

**IB**

IB

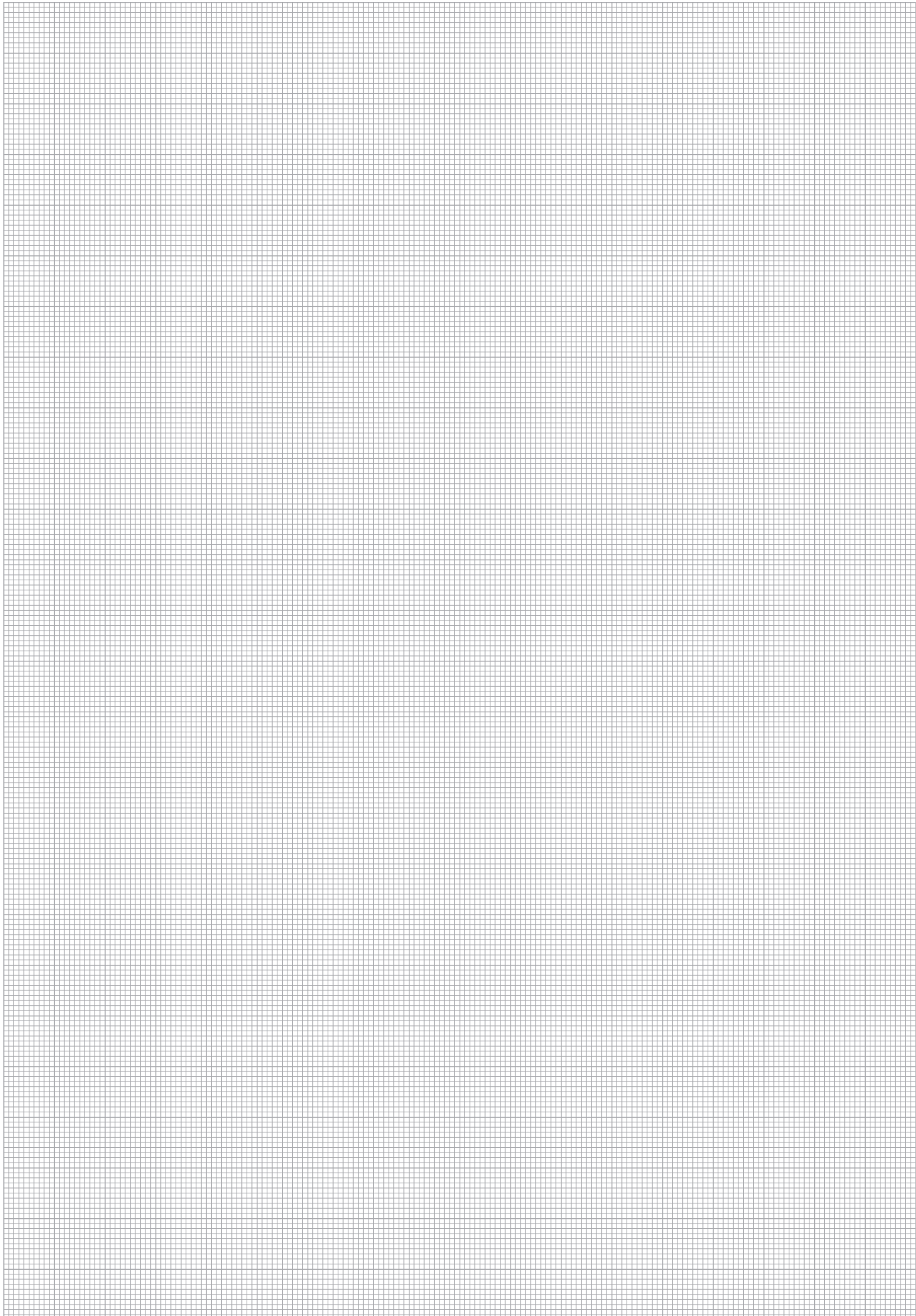



Series IB - Stainless Steel

Series IB - Overview	82	Series IB-51 - BG 9 - Nominal Size 51	84
Series IB-06 - BG 1 - Nominal Size 6,3	83	Series IB - Dust Protection	85
Series IB-10 - BG 2 - Nominal Size 10	83		
Series IB-12 - BG 3 - Nominal Size 12,5	83		
Series IB-19 - BG 4 - Nominal Size 19	83		
Series IB-25 - BG 6 - Nominal Size 25	84		
Series IB-38 - BG 8 - Nominal Size 38	84		



IB



### Series IB ▪ Stainless Steel

Material	Stainless Steel V4A (AISI 316)
Surface Finishing	-
Standard Seal Material(s)	FKM (Viton®) <sup>2</sup>
Working Temperature	-25° C ... +200° C / -13° F ... +392° F
Valve Design	Poppet Valve
Connection	Push and actuate Push Sleeve
Disconnection	Actuate Push Sleeve
Connect Under Pressure	not allowed
Application	Industrial Hydraulic
ISO Interchange	Up to DN 25 according to ISO 7241-1, Series B



<sup>2</sup> Alternative seal materials are available on request.

### Technical Data

Series	BG	DN Zoll	DN metric ISO 4397	Q <sub>max</sub>		Working Pressure		Bursting Pressure Connected		Female Body		Male Tip		Spillage	
				l/min	US GPM	bar	PSI	bar	PSI	bar	PSI	bar	PSI	ml	fl oz
IB-06	1	1/4"	6,3	24	6.34	350	5076	1600	23206	1500	21756	1700	24656	1	.0338
IB-10	2	3/8"	10	46	12.15	300	4351	2100	30458	1100	15954	1100	15954	2,4	.0812
IB-12	3	1/2"	12,5	90	23.78	300	4351	1500	21756	1400	20305	1500	21756	3,9	.1319
IB-19	4	3/4"	19 (20)	220	58.12	220	3191	1000	14504	900	13053	1000	14504	11	.3720
IB-25	6	1"	25	260	68.68	200	2901	850	12328	650	9427	600	8702	19	.6425
IB-38	8	1 1/2"	38	757	199.98	80	1160	250	3626	250	3626	250	3626	95	32.123
IB-51	9	2"	51	1000	264.17	60	870	200	2901	200	2901	200	2901	170	57.484

The indicated pressure ratings only apply to the coupling itself and depend on the connection type.

### Flow Characteristics

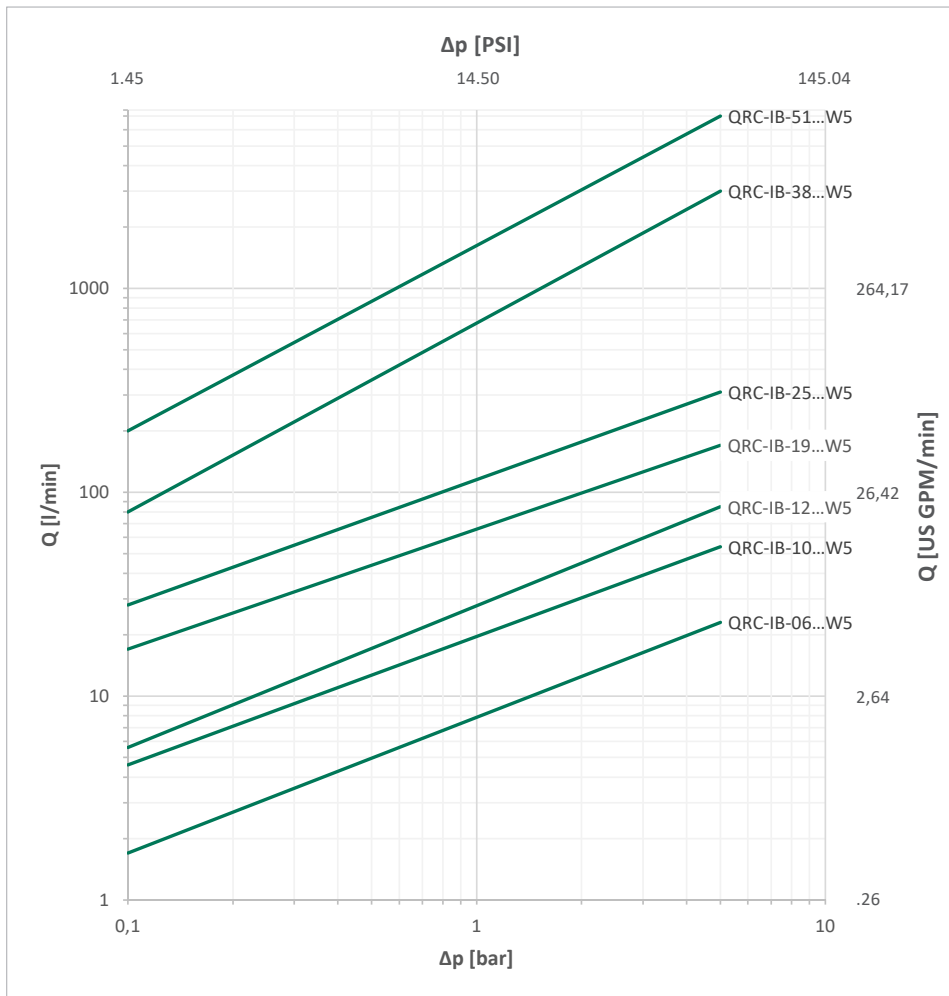

Please note: Unless otherwise stated, all flow characteristics have been determined with hydraulic oil with a kinematic viscosity of 28,8 - 35,2 mm<sup>2</sup>/s (28,8 - 35,2 cSt) and are only valid for components with non-reducing connections.



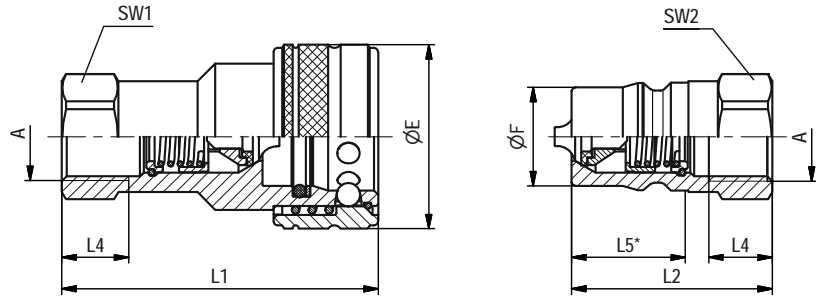

SW: Width across flats. All dimensions in mm (inch). Drawing similar Series IB-12.  
\* Insertion Male Tip.

### Series IB-06 • BG 1 • Nominal Size 6,3

Port A	Dimensions (mm/in)								Female Body Ordering Codes	Weight (kg/lbs) ca. per 100	Male Tip Ordering Codes	Weight (kg/lbs) ca. per 100	
	ØE	ØF	L1	L2	L4 min	L5	SW1	SW2					
Female Thread according to DIN 3852 - ISO 1179-1 - ANSI B 1.20.3													
	G 1/4"	28	14,2	60	38	12	21,5	19	19	QRC-IB-06-F-G04-VT-W5	13 28.66	QRC-IB-06-M-G04-V-W5	4 8.82
	NPTF 1/4" -18	28	14,2	60	38		21,5	19	19	QRC-IB-06-F-NF04-VT-W5	13,10 28.88	QRC-IB-06-M-NF04-V-W5	4,10 9.04

### Series IB-10 • BG 2 • Nominal Size 10

Port A	Dimensions (mm/in)								Female Body Ordering Codes	Weight (kg/lbs) ca. per 100	Male Tip Ordering Codes	Weight (kg/lbs) ca. per 100	
	ØE	ØF	L1	L2	L4 min	L5	SW1	SW2					
Female Thread according to DIN 3852 - ISO 1179-1 - ANSI B 1.20.3													
	G 3/8"	35	19,1	65,2	40,5	12	24,2	22	22	QRC-IB-10-F-G06-VT-W5	19,70 43.43	QRC-IB-10-M-G06-V-W5	6 13.23
	NPTF 3/8" -18	35	19,1	65,2	40,5		24,2	22	22	QRC-IB-10-F-NF06-VT-W5	19,80 43.65	QRC-IB-10-M-NF06-V-W5	6,10 13.45

### Series IB-12 • BG 3 • Nominal Size 12,5

Port A	Dimensions (mm/in)								Female Body Ordering Codes	Weight (kg/lbs) ca. per 100	Male Tip Ordering Codes	Weight (kg/lbs) ca. per 100	
	ØE	ØF	L1	L2	L4 min	L5	SW1	SW2					
Female Thread according to DIN 3852 - ISO 1179-1 - ANSI B 1.20.3													
	G 1/2"	44	23,55	73,7	46	14	27,2	27	27	QRC-IB-12-F-G08-VT-W5	34,60 76.28	QRC-IB-12-M-G08-V-W5	10,70 23.59
	NPTF 1/2" -14	44	23,55	73,7	46		27,2	27	27	QRC-IB-12-F-NF08-VT-W5	35 77.16	QRC-IB-12-M-NF08-V-W5	10,90 24.03

### Series IB-19 • BG 4 • Nominal Size 19

Port A	Dimensions (mm/in)								Female Body Ordering Codes	Weight (kg/lbs) ca. per 100	Male Tip Ordering Codes	Weight (kg/lbs) ca. per 100	
	ØE	ØF	L1	L2	L4 min	L5	SW1	SW2					
Female Thread according to DIN 3852 - ISO 1179-1 - ANSI B 1.20.3													
	G 3/4"	51,8	31,45	91,5	57	16	34	34	34	QRC-IB-19-F-G12-VT-W5	56 123.46	QRC-IB-19-M-G12-V-W5	21 46.30
	NPTF 3/4" -14	51,8	31,45	91,5	57		34	34	34	QRC-IB-19-F-NF12-VT-W5	56,50 124.56	QRC-IB-19-M-NF12-V-W5	21,50 47.40

Note: The connection of the two halves of a coupling is achieved depending on the type. It is important to observe the positive engagement of plug-type couplings and the secure tightening of screw-type couplings to the limit stop of the thread. Forced or improper separation will result in malfunction of the coupling.



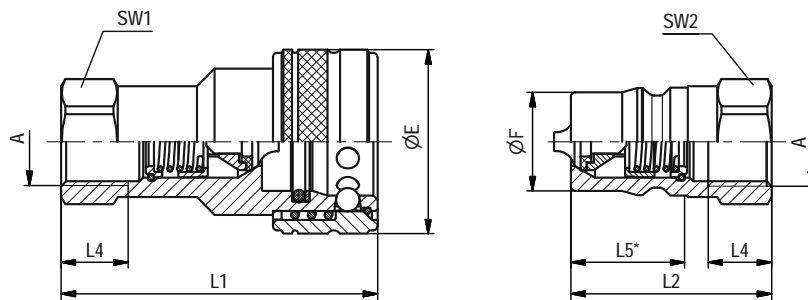

SW: Width across flats. All dimensions in mm (inch). Drawing similar Series IB-12.  
\* Insertion Male Tip.

### Series IB-25 ▪ BG 6 ▪ Nominal Size 25

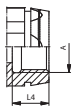
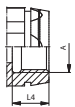
Port A	Dimensions (mm/in)								Female Body Ordering Codes	Weight (kg/lbs) ca. per 100	Male Tip Ordering Codes	Weight (kg/lbs) ca. per 100
	ØE	ØF	L1	L2	L4 min	L5	SW1	SW2				
Female Thread according to DIN 3852 - ISO 1179-1 - ANSI B 1.20.3												
 G 1"	60	37,8	103,8	63,5	18	39,3	41	41	QRC-IB-25-F-G16-VT-W5	90,80	QRC-IB-25-M-G16-V-W5	34,20
	2.36	1.49	4.09	2.50	.71	1.55	1.61	1.61		200.18		75.40
 NPTF 1" -11 1/2	60	37,8	103,8	63,5		39,3	41	41	QRC-IB-25-F-NF16-VT-W5	91,80	QRC-IB-25-M-NF16-V-W5	35,20
	2.36	1.49	4.09	2.50		1.55	1.61	1.61		202.38		77.60

### Series IB-38 ▪ BG 8 ▪ Nominal Size 38

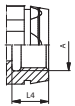
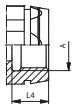
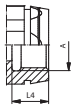
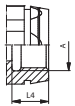
Port A	Dimensions (mm/in)								Female Body Ordering Codes	Weight (kg/lbs) ca. per 100	Male Tip Ordering Codes	Weight (kg/lbs) ca. per 100
	ØE	ØF	L1	L2	L4 min	L5	SW1	SW2				
Female Thread according to DIN 3852 - ISO 1179-1 - ANSI B 1.20.3												
 G 1 1/4"	78,5	44,45	126,5	127	20	52	65	65	QRC-IB-38-F-G20-VT-W5	216,60	QRC-IB-38-M-G20-V-W5	138,20
	3.09	1.75	4.98	5.00	.79	2.05	2.56	2.56		477.52		304.68
 NPTF 1 1/4" -11 1/2	78,5	44,45	126,5	127		52	65	65	QRC-IB-38-F-NF20-VT-W5	217,80	QRC-IB-38-M-NF20-V-W5	139,40
	3.09	1.75	4.98	5.00		2.05	2.56	2.56		480.17		307.32
 G 1 1/2"	78,5	44,45	126,5	127	22	52	65	65	QRC-IB-38-F-G24-VT-W5	208	QRC-IB-38-M-G24-V-W5	130,40
	3.09	1.75	4.98	5.00	.87	2.05	2.56	2.56		458.56		287.48
 NPTF 1 1/2" -11 1/2	78,5	44,45	126,5	127		52	65	65	QRC-IB-38-F-NF24-VT-W5	209,50	QRC-IB-38-M-NF24-V-W5	132
	3.09	1.75	4.98	5.00		2.05	2.56	2.56		461.87		291.01

### Series IB-51 ▪ BG 9 ▪ Nominal Size 51

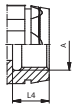
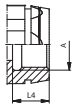
Port A	Dimensions (mm/in)								Female Body Ordering Codes	Weight (kg/lbs) ca. per 100	Male Tip Ordering Codes	Weight (kg/lbs) ca. per 100
	ØE	ØF	L1	L2	L4 min	L5	SW1	SW2				
Female Thread according to DIN 3852 - ISO 1179-1 - ANSI B 1.20.3												
 G 2"	105	63,2	142	142,5	24	63,5	90	90	QRC-IB-51-F-G32-VT-W5	497	QRC-IB-51-M-G32-V-W5	329
	4.13	2.49	5.59	5.61	.94	2.50	3.54	3.54		1095.70		725.32
 NPTF 2" -11 1/2	105	63,2	142	142,5		63,5	90	90	QRC-IB-51-F-NF32-VT-W5	505	QRC-IB-51-M-NF32-V-W5	330
	4.13	2.49	5.59	5.61		2.50	3.54	3.54		1113.33		727.53

Note: The connection of the two halves of a coupling is achieved depending on the type. It is important to observe the positive engagement of plug-type couplings and the secure tightening of screw-type couplings to the limit stop of the thread. Forced or improper separation will result in malfunction of the coupling.

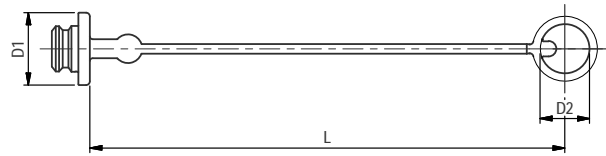
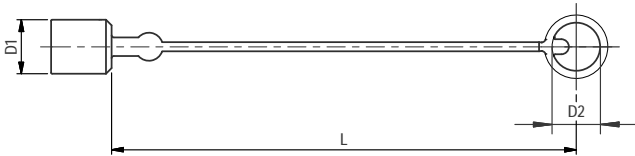

**Series IB • Dust Protection**

Dimensions (mm/in)			Material	Dust Cap for Male Tip
D1	D2	L		Ordering Codes
18	23	240	Plastic (Colour: Red)	QRC-IB-06-DM-23-KI-RD
.71	.91	9.45		
23	24	240	Plastic (Colour: Red)	QRC-IB-10-DM-24-KI-RD
.91	.94	9.45		
29	28	245	Plastic (Colour: Red)	QRC-IB-12-DM-28-KI-RD
1.14	1.10	9.65		
36,0	38	245	Plastic (Colour: Red)	QRC-IB-19-DM-38-KI-RD
1.42	1.50	9.65		
44	44	253	Plastic (Colour: Red)	QRC-IB-25-DM-44-KI-RD
1.73	1.73	9.96		

Dimensions (mm/in)			Material	Dust Plug for Female Body
D1	D2	L		Ordering Codes
26	23	240	Plastic (Colour: Red)	QRC-IB-06-DF-23-KI-RD
1.02	.91	9.45		
33	25	235	Plastic (Colour: Red)	QRC-IB-10-DF-25-KI-RD
1.30	.98	9.25		
38	29	240	Plastic (Colour: Red)	QRC-IB-12-DF-29-KI-RD
1.50	1.14	9.45		
49	38	240	Plastic (Colour: Red)	QRC-IB-19-DF-38-KI-RD
1.93	1.50	9.45		
60	46	245	Plastic (Colour: Red)	QRC-IB-25-DF-46-KI-RD
2.36	1.81	9.65		

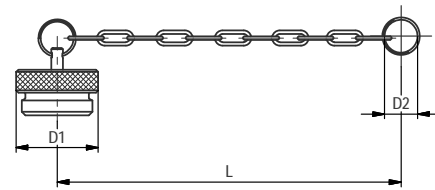
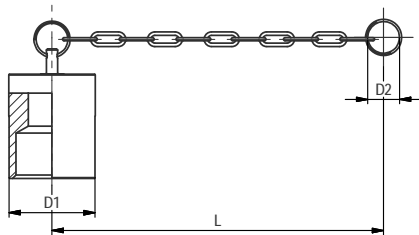

Dimensions (mm/in)			Material	Dust Cap for Male Tip
D1	D2	L		Ordering Codes
22	28	245	Aluminium with chain	QRC-IB-06-DM-28/CN-W89-SI
.87	1.10	9.65		
27	30	155	Aluminium with chain	QRC-IB-10-DM-30/CN-W89-SI
1.06	1.18	6.10		
35	41	265	Aluminium with chain	QRC-IB-12-DM-41/CN-W89-SI
1.38	1.61	10.43		
42	30	250	Aluminium with chain	QRC-IB-19-DM-30/CN-W89-SI
1.65	1.18	9.84		
48	49	340	Aluminium with chain	QRC-IB-25-DM-49/CN-W89-SI
1.89	1.93	13.39		
55	46	225	Aluminium with chain	QRC-IB-38-DM-46/CN-W89-SI
2.17	1.81	8.86		
80	75	350	Aluminium with chain	QRC-IB-51-DM-75/CN-W89-SI
3.15	2.95	13.78		

Dimensions (mm/in)			Material	Dust Plug for Female Body
D1	D2	L		Ordering Codes
22	30	210	Aluminium with chain	QRC-IB-06-DF-30/CN-W89-SI
.87	1.18	8.27		
22	30	155	Aluminium with chain	QRC-IB-10-DF-30/CN-W89-SI
.87	1.18	6.10		
28	41	305	Aluminium with chain	QRC-IB-12-DF-41/CN-W89-SI
1.10	1.61	12.01		
35	43	265	Aluminium with chain	QRC-IB-19-DF-43/CN-W89-SI
1.38	1.69	10.43		
44	41	240	Aluminium with chain	QRC-IB-25-DF-41/CN-W89-SI
1.73	1.61	9.45		
74	46	225	Aluminium with chain	QRC-IB-38-DF-46/CN-W89-SI
2.91	1.81	8.86		
105	75	350	Aluminium with chain	QRC-IB-51-DF-75/CN-W89-SI
4.13	2.95	13.78		

In addition to the standard colours as stated above, plastic dust caps are also available in blue, green, yellow and black. Please use the color codes BU, GN, YE and BK respectively instead of RD.



IB

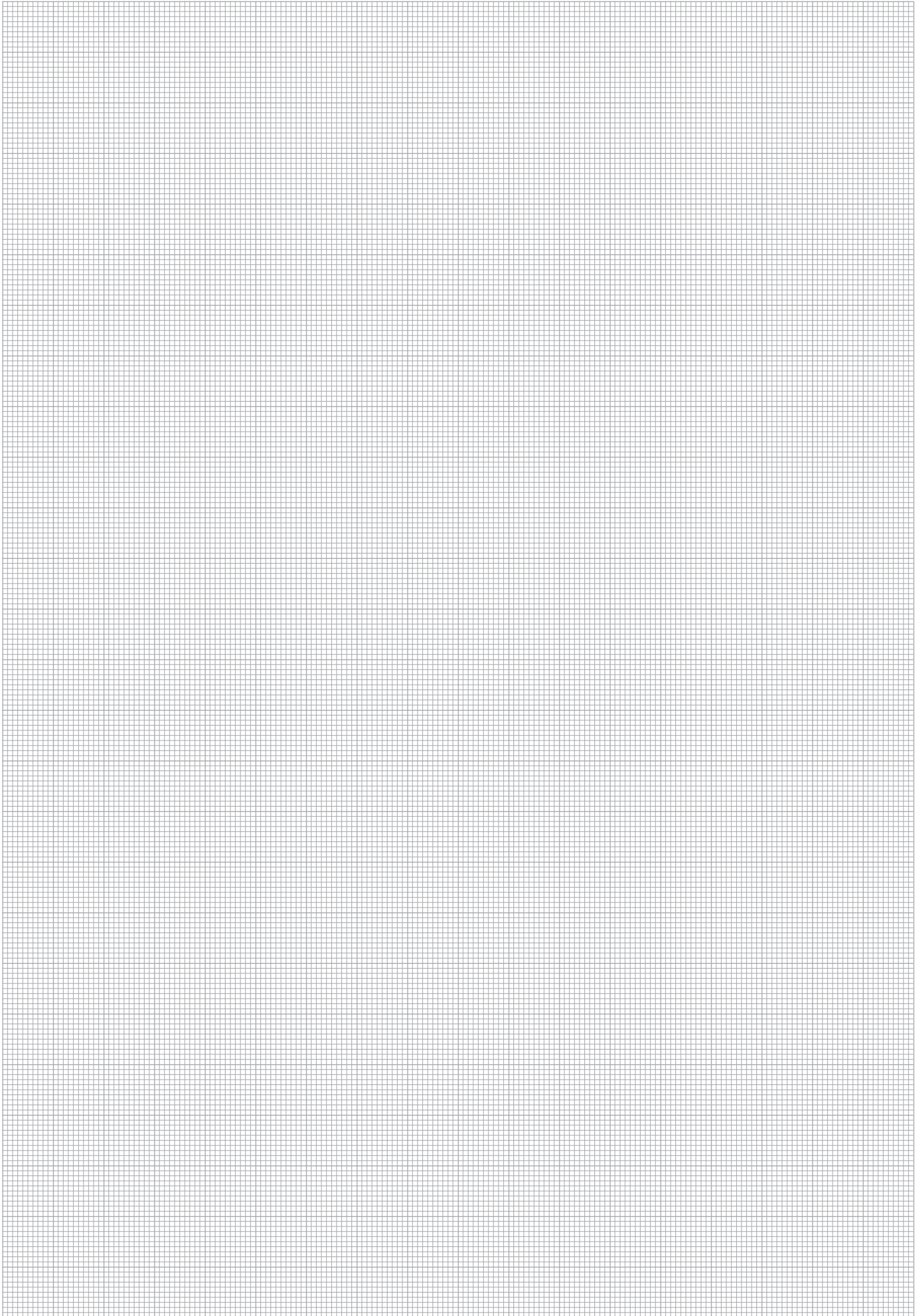

Series ID - Carbon Steel

Series ID - Overview	88
Series ID-06 - BG 1 - Nominal Size 6,3	89
Series ID-10 - BG 2 - Nominal Size 10	89
Series ID-19 - BG 4 - Nominal Size 19	89
Series ID-25 - BG 6 - Nominal Size 25	89
Series ID - Dust Protection	90



ID



### Series ID • Carbon Steel

Material	Carbon Steel
Surface Finishing	Zinc-Nickel
Standard Seal Material(s)	NBR (Buna-N®) <sup>2</sup>
Working Temperature	-25° C ... +100° C / -13° F ... +212° F
Valve Design	Poppet Valve
Connection	Push and actuate Push Sleeve
Disconnection	Actuate Push Sleeve
Connect Under Pressure	not allowed
Application	Industrial Hydraulic
ISO Interchange	-



<sup>2</sup>Alternative seal materials are available on request.

### Technical Data

Series	BG	DN Zoll Inch	DN metric ISO 4397	Q <sub>max</sub>		Working Pressure		Bursting Pressure Connected		Female Body		Male Tip		Spillage	
				l/min	US GPM	bar	PSI	bar	PSI	bar	PSI	bar	PSI	ml	fl oz
ID-06	1	1/4"	6,3	24	6.34	350	5076							1	.0338
ID-10	2	3/8"	10	46	12.15	350	5076	1500	21756	1700	24656	1500	21756	2,4	.0812
ID-12	Technical data according to QRC-IA-12 series, see page 58														
ID-19	4	3/4"	19 (20)	190	50.19	250	3626	1100	15954	1200	17405	1000	14504	8,6	.2908
ID-25	6	1"	25	250	66.04	250	3626	1000	14504	1100	15954	1200	17405	13	.4396

The indicated pressure ratings only apply to the coupling itself and depend on the connection type.

ID

### Flow Characteristics

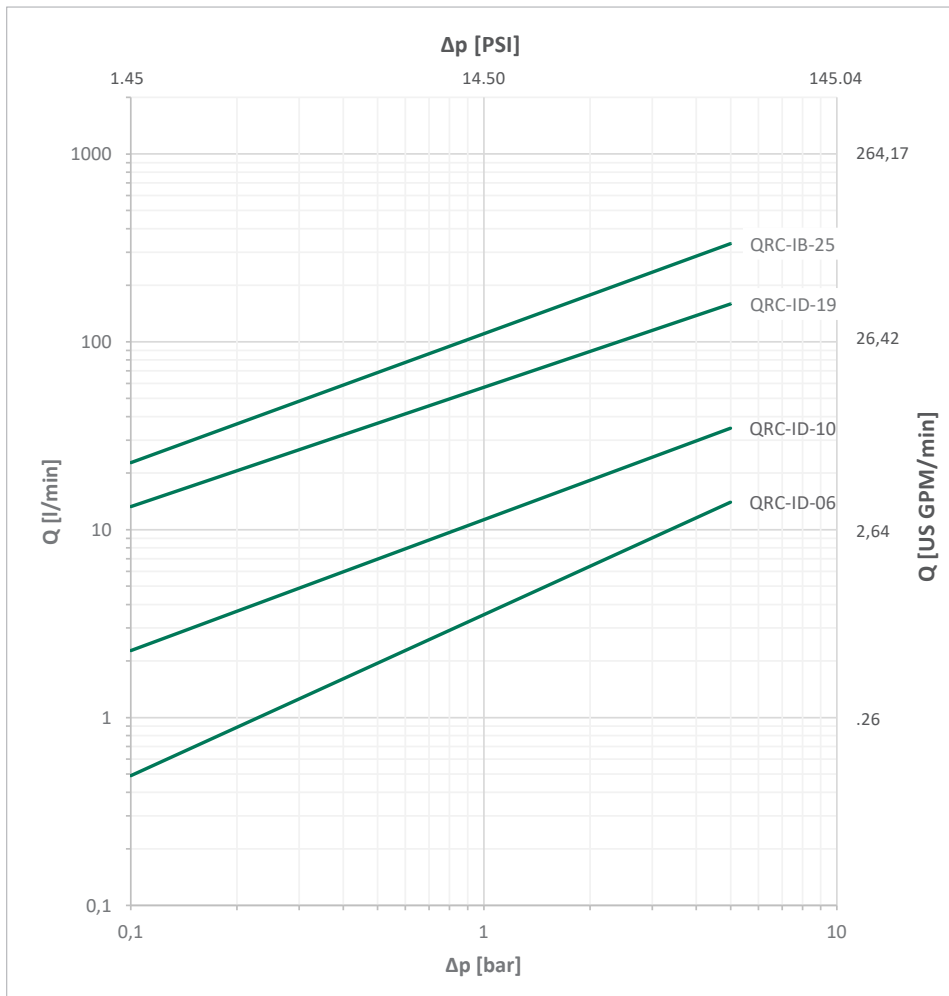

Please note: Unless otherwise stated, all flow characteristics have been determined with hydraulic oil with a kinematic viscosity of 28,8 - 35,2 mm<sup>2</sup>/s (28,8 - 35,2 cSt) and are only valid for components with non-reducing connections.





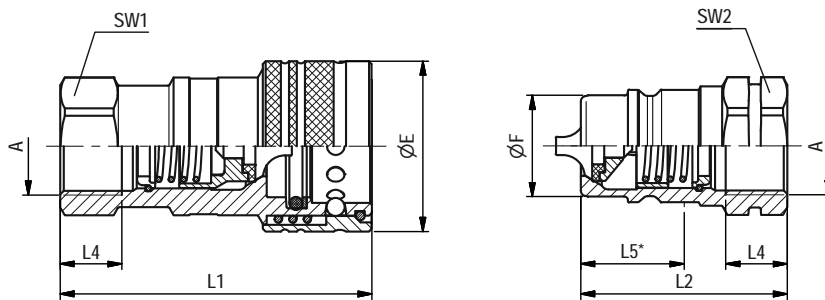

SW: Width across flats. All dimensions in mm (inch). Drawing similar Series ID-19.  
\* Insertion Male Tip.

### Series ID-06 • BG 1 • Nominal Size 6,3

Port A	Dimensions (mm/in)							Female Body		Weight ( <sup>kg</sup> /lbs) ca. per 100	Male Tip		Weight ( <sup>kg</sup> /lbs) ca. per 100
	ØE	ØF	L1	L2	L4 min	L5	SW1	SW2	Ordering Codes		Ordering Codes		
Female Thread according to DIN 3852 - ISO 1179-1 - ANSI B 1.20.3													
	G 1/4"	27,6	14,2	55,5	36	12,5		22,2	19	QRC-ID-06-F-G04-BT-W3	12,9	QRC-ID-06-M-G04-B-W3	4,40
		1,09	.56	2.19	1.42	.49		.87	.75		28.44		9.70
	NPTF 1/4" -18	27,6	14,2	55,5	36			22,2	19	QRC-ID-06-F-NF04-BT-W3	13,03	QRC-ID-06-M-NF04-B-W3	4,40
		1,09	.56	2.19	1.42			.87	.75		28.73		9.70

### Series ID-10 • BG 2 • Nominal Size 10

Port A	Dimensions (mm/in)							Female Body		Weight ( <sup>kg</sup> /lbs) ca. per 100	Male Tip		Weight ( <sup>kg</sup> /lbs) ca. per 100	
	ØE	ØF	L1	L2	L4 min	L5	SW1	SW2	Ordering Codes		Ordering Codes			
Female Thread according to DIN 3852 - ISO 1179-1 - ANSI B 1.20.3														
	G 3/8"	34	19	60,5	40	13	20	24	24	QRC-ID-10-F-G06-BT-W3	20	QRC-ID-10-M-G06-B-W3	8	
		1,34	.75	2.38	1.57	.51	.79	.94	.94		44.09		17.64	
	NPTF 3/8" -18	34	19	60,5	40			20	24	24	QRC-ID-10-F-NF06-BT-W3	20,10	QRC-ID-10-M-NF06-B-W3	8,10
		1,34	.75	2.38	1.57			.79	.94	.94		44.31		17.86

### Series ID-19 • BG 4 • Nominal Size 19

Port A	Dimensions (mm/in)							Female Body		Weight ( <sup>kg</sup> /lbs) ca. per 100	Male Tip		Weight ( <sup>kg</sup> /lbs) ca. per 100	
	ØE	ØF	L1	L2	L4 min	L5	SW1	SW2	Ordering Codes		Ordering Codes			
Female Thread according to DIN 3852 - ISO 1179-1 - ANSI B 1.20.3														
	G 3/4"	47,5	51	83	51	18	31	35	33,3	QRC-ID-19-F-G12-BT-W3	51,60	QRC-ID-19-M-G12-B-W3	17,65	
		1,87	2,01	3,27	2,01	.71	1,22	1,38	1,31		113.76		38.91	
	NPTF 3/4" -14	47,5	51	83	51			31	35	33,3	QRC-ID-19-F-NF12-BT-W3	50,90	QRC-ID-19-M-NF12-B-W3	14,92
		1,87	2,01	3,27	2,01			1,22	1,38	1,31		112.21		32.89

### Series ID-25 • BG 6 • Nominal Size 25

Port A	Dimensions (mm/in)							Female Body		Weight ( <sup>kg</sup> /lbs) ca. per 100	Male Tip		Weight ( <sup>kg</sup> /lbs) ca. per 100	
	ØE	ØF	L1	L2	L4 min	L5	SW1	SW2	Ordering Codes		Ordering Codes			
Female Thread according to DIN 3852 - ISO 1179-1 - ANSI B 1.20.3														
	G 1"	56,2	31,3	97,5	64	21	32,7	41	41	QRC-ID-25-F-G16-BT-W3	73,60	QRC-ID-25-M-G16-B-W3	28,20	
		2,21	1,23	3,84	2,52	.83	1,29	1,61	1,61		162.26		62.17	
	NPTF 1" -11 1/2	56,2	31,3	97,5	64			32,7	41	41	QRC-ID-25-F-NF16-BT-W3	74,30	QRC-ID-25-M-NF16-B-W3	28,90
		2,21	1,23	3,84	2,52			1,29	1,61	1,61		163.80		63.71

Series ID-12: Technical data according to QRC-IA-12 series, see page 60

Note: The connection of the two halves of a coupling is achieved depending on the type. It is important to observe the positive engagement of plug-type couplings and the secure tightening of screw-type couplings to the limit stop of the thread. Forced or improper separation will result in malfunction of the coupling.



Series ID ▪ Dust Protection

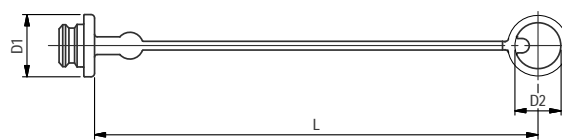
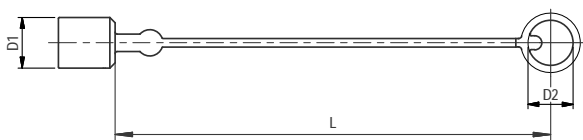

Dimensions (mm/in)			Material	Dust Cap for Male Tip
D1	D2	L		Ordering Codes
22	25	210	Plastic (Colour: Red)	QRC-ID-06-DM-25-KI-RD
.87	.98	8.27		
27	24	205	Plastic (Colour: Red)	QRC-ID-10-DM-24-KI-RD
1.06	.94	8.07		
37	33	270	Plastic (Colour: Red)	QRC-ID-19-DM-33-KI-RD
1.46	1.30	10.63		
41,0	39	290	Plastic (Colour: Red)	QRC-ID-25-DM-39-KI-RD
1.61	1.54	11.42		

Dimensions (mm/in)			Material	Dust Plug for Female Body
D1	D2	L		Ordering Codes
25	18	205	Plastic (Colour: Red)	QRC-ID-06-DF-18-KI-RD
.98	.71	8.07		
30	24	235	Plastic (Colour: Red)	QRC-ID-10-DF-24-KI-RD
1.18	.94	9.25		
44	33	270	Plastic (Colour: Red)	QRC-ID-19-DF-33-KI-RD
1.73	1.30	10.63		
50	39	290	Plastic (Colour: Red)	QRC-ID-25-DF-39-KI-RD
1.97	1.54	11.42		

In addition to the standard colours as stated above, plastic dust caps are also available in blue, green, yellow and black. Please use the color codes BU, GN, YE and BK respectively instead of RD.

ID



Series BP • Carbon Steel

Series BP • Overview	92
Series BP-12 • BG 3 • Nominal Size 12,5	93
Series BP • Dust Protection	93



BP



### Series BP ▪ Carbon Steel

Material	Carbon Steel
Surface Finishing	Zinc-Nickel
Standard Seal Material(s)	NBR (Buna-N®), PTFE <sup>2</sup>
Working Temperature	-25° C ... +100° C / -13° F ... +212° F
Valve Design	Flat Face
Connection	Push and actuate Push Sleeve
Disconnection	Actuate Push Sleeve
Connect Under Pressure	not allowed
Application	Agricultural and Forestry Machinery
ISO Interchange	ISO 5676



<sup>2</sup>Alternative seal materials are available on request.

### Technical Data

Series	BG	DN Zoll Inch	DN metric ISO 4397	Q <sub>max</sub>		Working Pressure		Bursting Pressure Connected		Female Body		Male Tip		Spillage	
				l/min	US GPM	bar	PSI	bar	PSI	bar	PSI	bar	PSI	ml	fl oz
BP-12	3	1/2"	12,5	70	18.49	150	2176	930	13489	620	8992	900	13053	0,05	.0017

The indicated pressure ratings only apply to the coupling itself and depend on the connection type.

BP

### Flow Characteristics

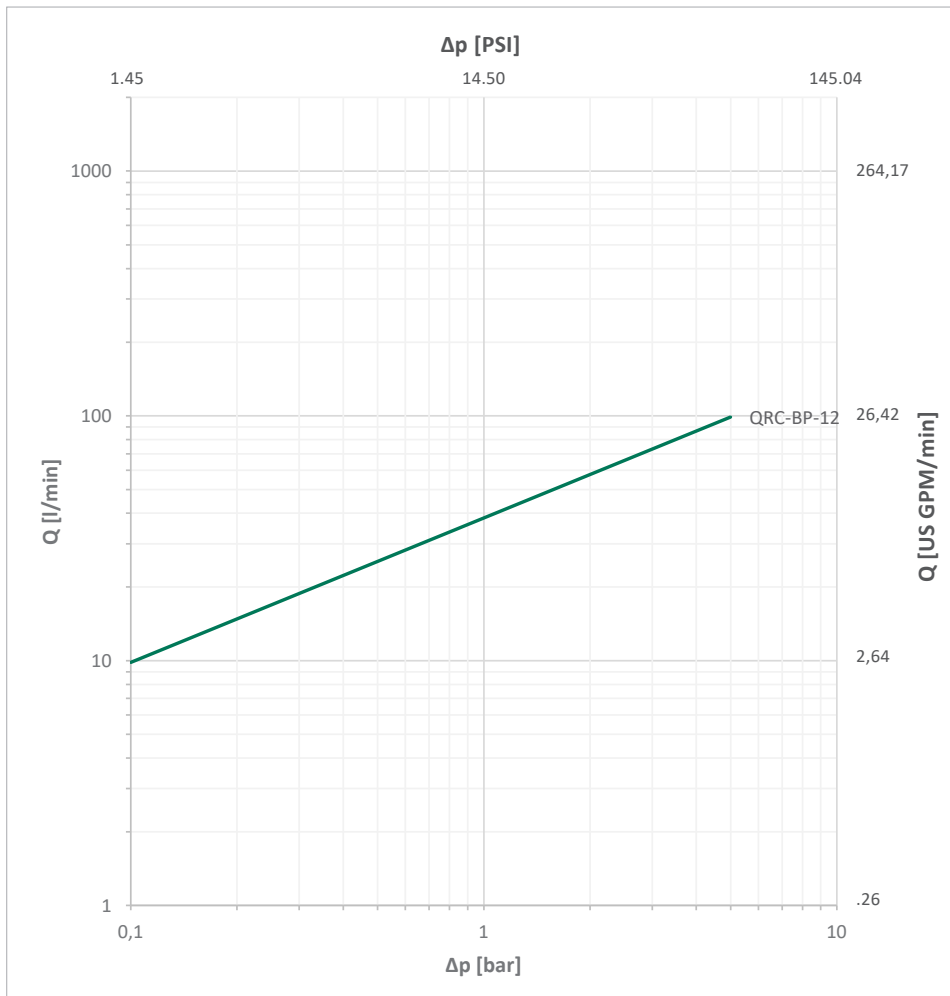

Please note: Unless otherwise stated, all flow characteristics have been determined with hydraulic oil with a kinematic viscosity of 28,8 - 35,2 mm<sup>2</sup>/s (28,8 - 35,2 cSt) and are only valid for components with non-reducing connections.



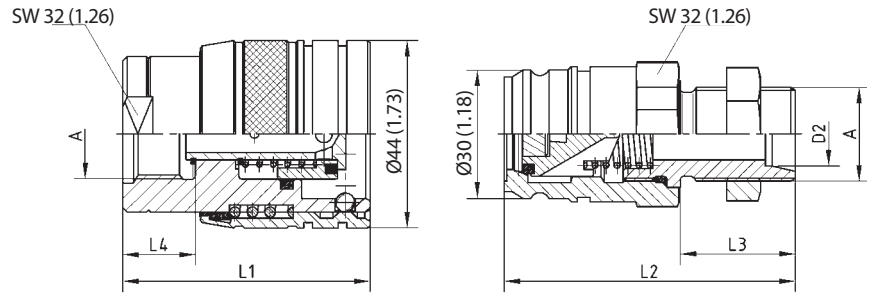

SW: Width across flats. All dimensions in mm (inch).

**Series BP-12 • BG 3 • Nominal Size 12,5**

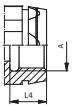
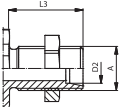
Port A	Dimensions (mm/in)					Female Body Ordering Codes	Weight (kg/lbs) ca. per 100	Male Tip Ordering Codes	Weight (kg/lbs) ca. per 100
	ØD2	L1	L2	L3	L4				
<b>Female Thread according to DIN 3852 - ISO 1179-1</b>									
	G 1/2"		55,5 2.19			15 .59	<b>QRC-BP-12-F-G08-BT-W3</b> 38,6 85.1		
	M18x1,5		55,5 2.19			15 .59	<b>QRC-BP-12-F-M180R-BT-W3</b> 37,9 83.56		
<b>Male Thread with 24° Conical Bore - Bulkhead - Shape W according to DIN 3861</b>									
	M18x1,5	12L		58,5 2.34	26 1.04		<b>QRC-BP-12-M-12LB-B-W3</b> 17,07 37.63		
	M22x1,5	15L		58,5 2.34	26 1.04		<b>QRC-BP-12-M-15LB-B-W3</b> 19,7 43.43		

**BP**
**Series BP • Dust Protection**

Dimensions (mm/in)			Material	Dust Cap for Male Tip
D1	D2	L		Ordering Codes
30	29,5	185	Plastic (Colour: Red)	<b>QRC-BP-10-DM-30-K-RD</b>
1.18	1.16	7.28		

Dimensions (mm/in)			Material	Dust Plug for Female Body
D1	D2	L		Ordering Codes
29	29,5	185	Plastic (Colour: Red)	<b>QRC-BP-10-DF-30-K-RD</b>
1.14	1.16	7.28		

Note: The connection of the two halves of a coupling is achieved depending on the type. It is important to observe the positive engagement of plug-type couplings and the secure tightening of screw-type couplings to the limit stop of the thread. Forced or improper separation will result in malfunction of the coupling.



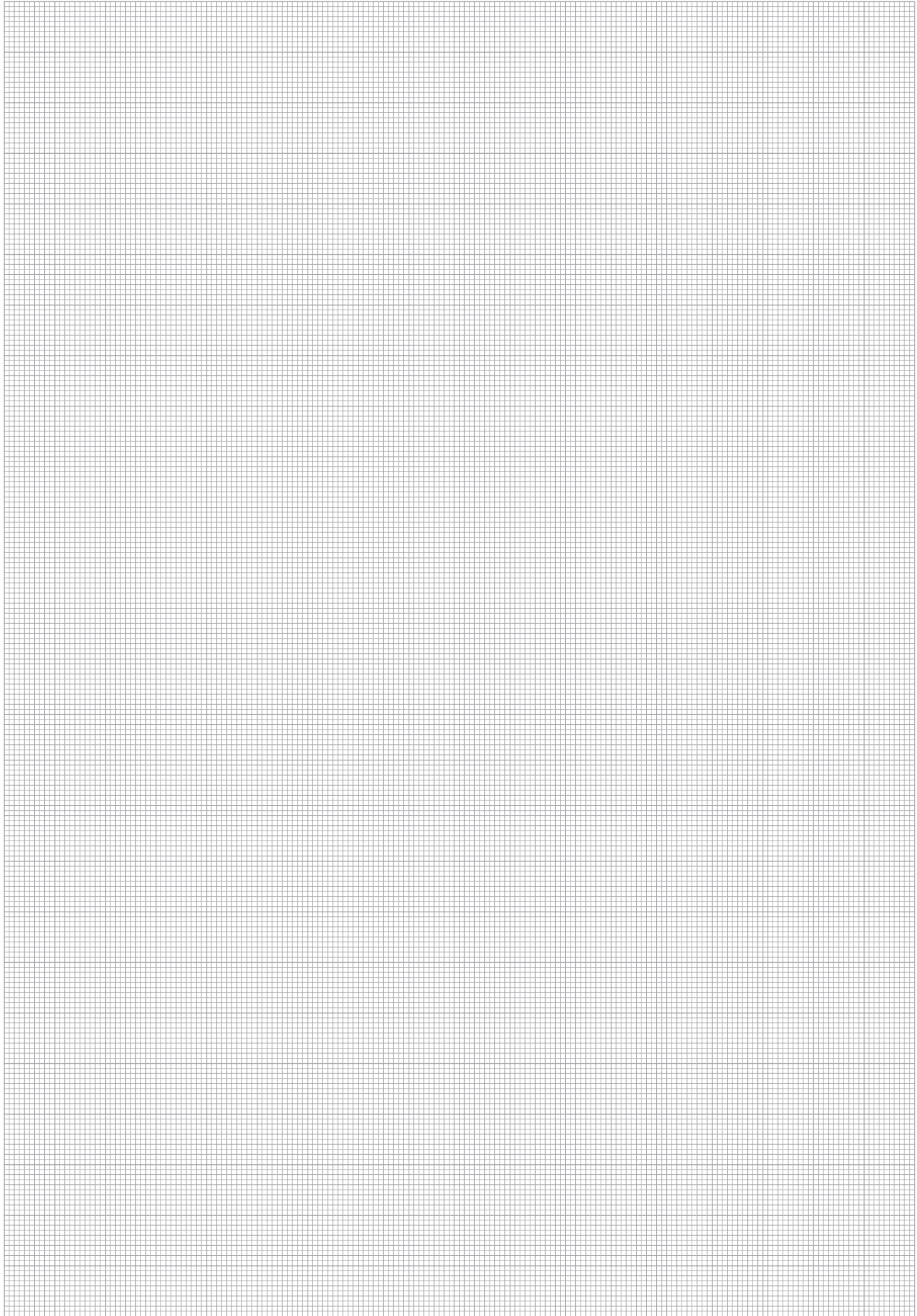

BP



Series HC • Carbon Steel

Series HC • Overview	96
Series HC-06 • BG 1 • Nominal Size 6,3	97
Series HC • Dust Protection	97



HC



### Series HC ▪ Carbon Steel

Material	Carbon Steel
Surface Finishing	Zinc-Plating and Thick-Film-Passivation (Chrome III)
Standard Seal Material(s)	Special compound <sup>2</sup>
Working Temperature	-35° C ... +130° C / -31° F ... +266° F
Valve Design	Flat Face
Connection	Push and actuate Push Sleeve
Disconnection	Actuate Push Sleeve
Connect Under Pressure	not allowed
Application	Rescue and Tensioning Hydraulics
ISO Interchange	-



<sup>2</sup>Alternative seal materials are available on request.

### Technical Data

Series	BG	DN Zoll Inch	DN metric ISO 4397	Q <sub>max</sub>		Working Pressure		Bursting Pressure Connected		Female Body		Male Tip		Spillage	
				l/min	US GPM	bar	PSI	bar	PSI	bar	PSI	bar	PSI	ml	fl oz
HC-06	1	1/4"	6,3	6	1.59	1000	14504	2500	36260	2500	36260	2500	36260	0,008	.0003

The indicated pressure ratings only apply to the coupling itself and depend on the connection type.

HC

### Flow Characteristics

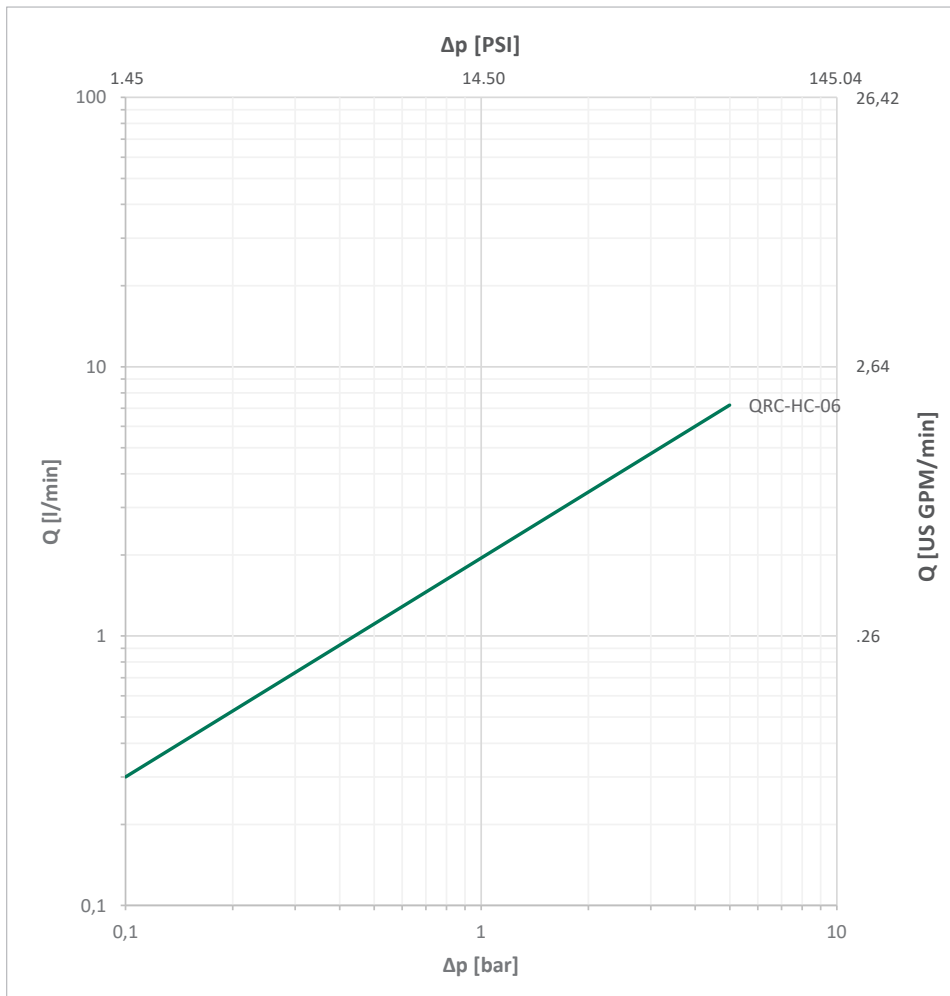

Please note: Unless otherwise stated, all flow characteristics have been determined with hydraulic oil with a kinematic viscosity of 28,8 - 35,2 mm<sup>2</sup>/s (28,8 - 35,2 cSt) and are only valid for components with non-reducing connections.





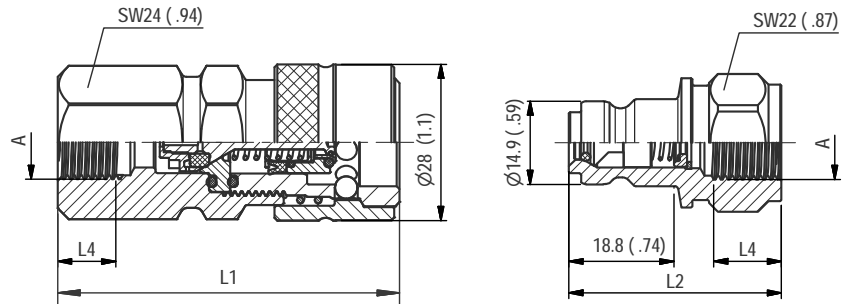

SW: Width across flats. All dimensions in mm (inch).

**Series HC-06 ▪ BG 1 ▪ Nominal Size 6,3**

Port A	Dimensions (mm/in)				Female Body Ordering Codes	Weight (kg/lbs) ca. per 100	Male Tip Ordering Codes	Weight (kg/lbs) ca. per 100	
	ØD2	L1	L2	L3					L4 min
<b>Female Thread according to DIN 3852 - ISO 1179-1 - ANSI B 1.20.3</b>									
	G 1/8"	54,3 2.14	38,1 1.50		8 0.31	<b>QRC-HC-06-F-G02-Y-W66</b>	17,60 38.80	<b>QRC-HC-06-M-G02-Y-W66</b>	7,80 17.20
	G 1/4"	61,3 2.41	38,1 1.50		12 0.47	<b>QRC-HC-06-F-G04-Y-W66</b>	19,50 42.99	<b>QRC-HC-06-M-G04-Y-W66</b>	7,10 15.65
	NPTF 1/4" -18	58,3 2.30	35,7 1.41			<b>QRC-HC-06-F-NF04-Y-W66</b>	18,60 41.01	<b>QRC-HC-06-M-NF04-Y-W66</b>	6,70 14.77
	G 3/8"	63,3 2.49	39,6 1.56		12 0.47	<b>QRC-HC-06-F-G06-Y-W66</b>	19,30 42.55	<b>QRC-HC-06-M-G06-Y-W66</b>	8,40 18.52
	NPTF 3/8" -18	60,3 2.37	39,6 1.56			<b>QRC-HC-06-F-NF06-Y-W66</b>	18,50 40.79	<b>QRC-HC-06-M-NF06-Y-W66</b>	7,80 17.20

**Series HC ▪ Dust Protection**

Dimensions (mm/in)			Material	Dust Cap for Male Tip
D1	D2	L		Ordering Codes
29 1.14	22,5 .89	110 4.33	Plastic (Colour: Red)	<b>QRC-HC-06-DM-23-KI-RD</b>

Dimensions (mm/in)			Material	Dust Plug for Female Body
D1	D2	L		Ordering Codes
29 1.14	20,5 .81	110 4.33	Plastic (Colour: Red)	<b>QRC-HC-06-DF-21-KI-RD</b>

In addition to the standard colours as stated above, plastic dust caps are also available in blue, green, yellow and black. Please use the color codes BU, GN, YE and BK respectively instead of RD.

**HC**

Note: The connection of the two halves of a coupling is achieved depending on the type. It is important to observe the positive engagement of plug-type couplings and the secure tightening of screw-type couplings to the limit stop of the thread. Forced or improper separation will result in malfunction of the coupling.



HC

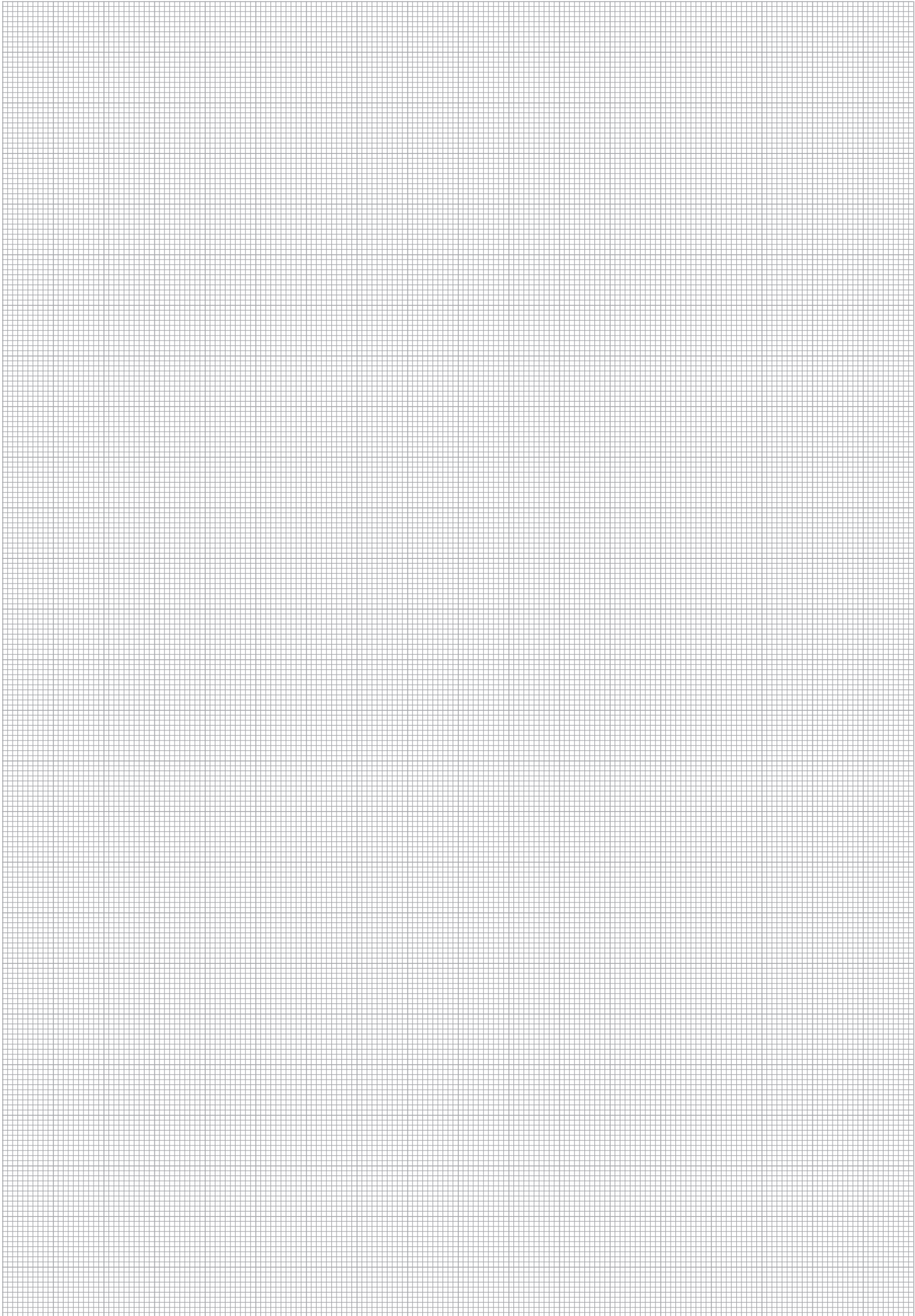

Series HD • Carbon Steel

Series HD • Overview	100
Series HD-06 • BG 1 • Nominal Size 6,3	101
Series HD • Dust Protection	101



HD



### Series HD ▪ Carbon Steel

Material	Carbon Steel
Surface Finishing	Zinc-Plating and Thick-Film-Passivation (Chrome III)
Standard Seal Material(s)	Special compound <sup>2</sup>
Working Temperature	-35° C ... +130° C / -31° F ... +266° F
Valve Design	Flat Face
Connection	Push and actuate Push Sleeve
Disconnection	Actuate Push Sleeve
Connect Under Pressure	not allowed
Application	Rescue and Tensioning Hydraulics
ISO Interchange	-



<sup>2</sup>Alternative seal materials are available on request.

### Technical Data

Series	BG	DN Zoll Inch	DN metric ISO 4397	Q <sub>max</sub>		Working Pressure		Bursting Pressure Connected		Female Body		Male Tip		Spillage	
				l/min	US GPM	bar	PSI	bar	PSI	bar	PSI	bar	PSI	ml	fl oz
HD-06	1	1/4"	6,3	6	1.59	1500	21756	3500	50763	3500	50763	3500	50763	0,008	.0003

The indicated pressure ratings only apply to the coupling itself and depend on the connection type.

HD

### Flow Characteristics

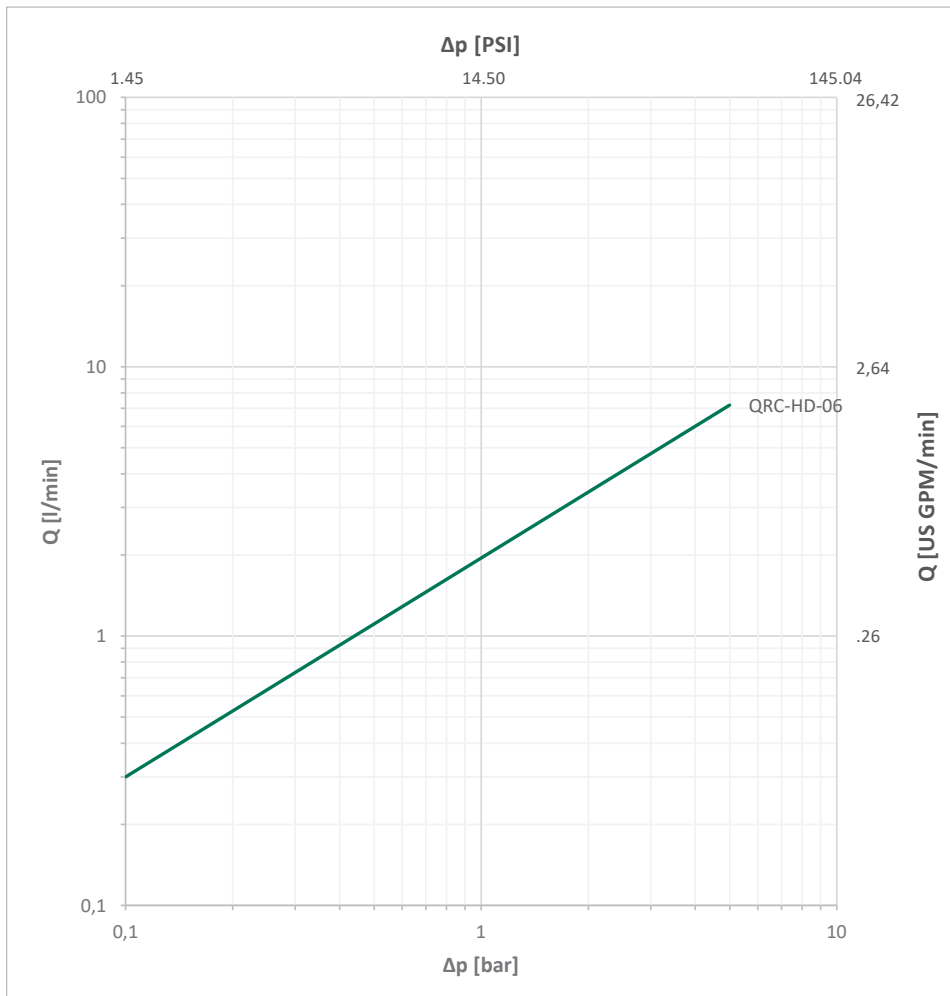

Please note: Unless otherwise stated, all flow characteristics have been determined with hydraulic oil with a kinematic viscosity of 28,8 - 35,2 mm<sup>2</sup>/s (28,8 - 35,2 cSt) and are only valid for components with non-reducing connections.



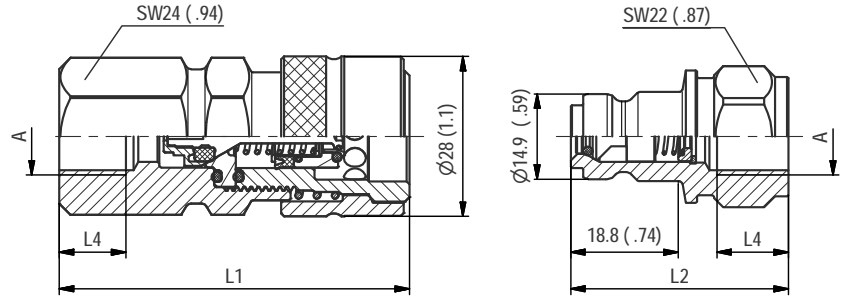

SW: Width across flats. All dimensions in mm (inch).

**Series HD-06 ▪ BG 1 ▪ Nominal Size 6,3**

Port A	Dimensions (mm/in)					Female Body Ordering Codes	Weight ( <sup>kg</sup> /lbs) ca. per 100	Male Tip Ordering Codes	Weight ( <sup>kg</sup> /lbs) ca. per 100
	$\varnothing D2$	L1	L2	L3	L4 min				
Female Thread according to DIN 3852 - ISO 1179-1 - ANSI B 1.20.3									
	G 1/4"	61,3 2.41	38,1 1.50		12 0.47	QRC-HD-06-F-G04-Y-W66	19,60 43.21	QRC-HD-06-M-G04-Y-W66	7,10 15.65
	NPTF 1/4" -18	58,3 2.30	35,7 1.41				QRC-HD-06-F-NF04-Y-W66	18,60 41.01	QRC-HD-06-M-NF04-Y-W66

**Series HD ▪ Dust Protection**

**HD**

Dimensions (mm/in)			Material	Dust Cap for Male Tip
D1	D2	L		Ordering Codes
29	22,5	110	Plastic (Colour: Black)	QRC-HD-06-DM-23-KI-BK
1.14	.89	4.33		

Dimensions (mm/in)			Material	Dust Plug for Female Body
D1	D2	L		Ordering Codes
29	20,5	110	Plastic (Colour: Black)	QRC-HD-06-DF-21-KI-BK
1.14	.81	4.33		

Note: The connection of the two halves of a coupling is achieved depending on the type. It is important to observe the positive engagement of plug-type couplings and the secure tightening of screw-type couplings to the limit stop of the thread. Forced or improper separation will result in malfunction of the coupling.



HD

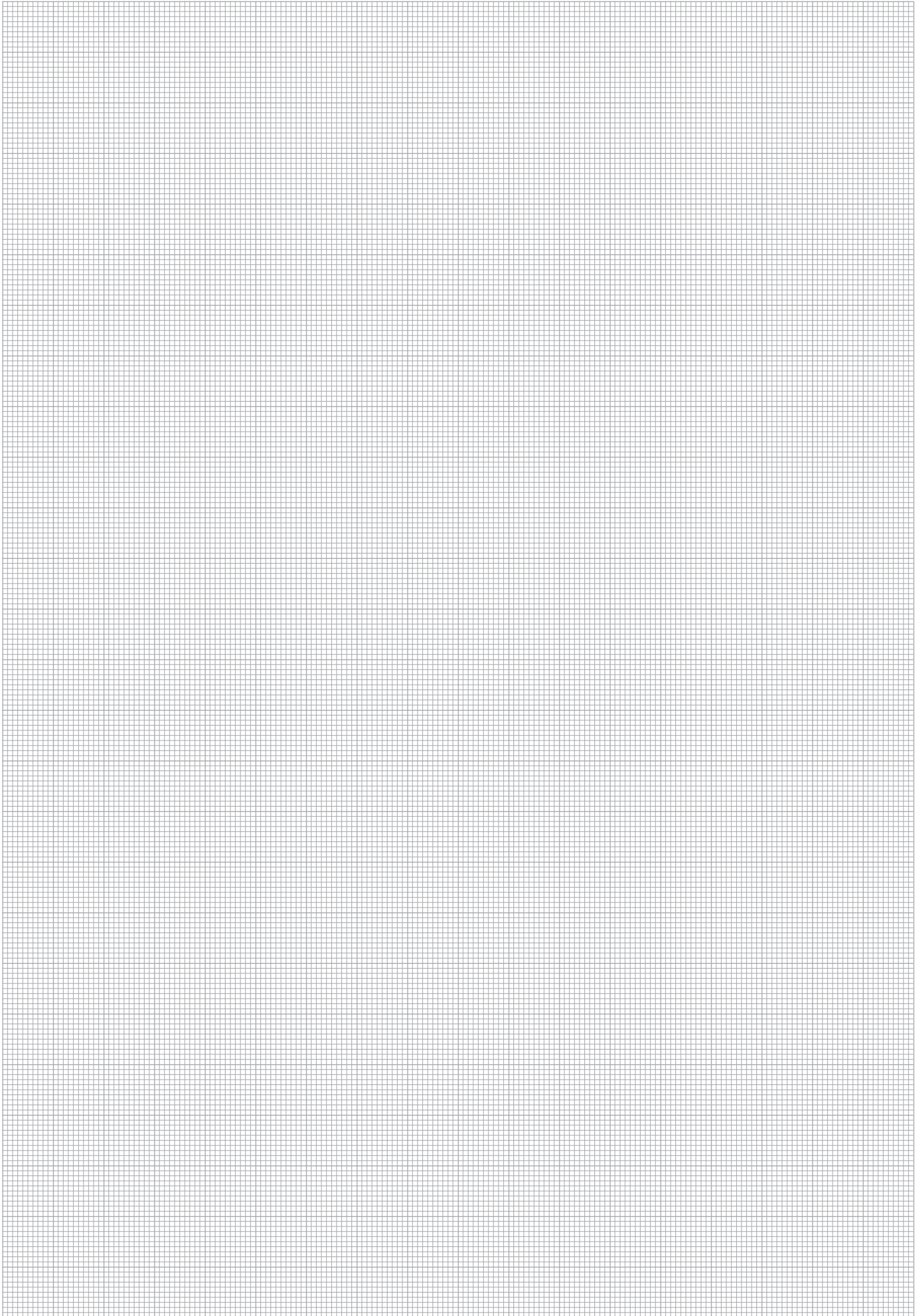

Series HUS - Carbon Steel

Series HUS - Overview	104
Series HUS-10 - BG 2 - Nominal Size 10	105
Series HUS-12 - BG 3 - Nominal Size 12,5	105
Series HUS-19 - BG 4 - Nominal Size 19	105
Series HUS-25 - BG 6 - Nominal Size 25	105



HUS



### Series HUS - Carbon Steel

Material	Carbon Steel
Surface Finishing	Zinc-Nickel
Standard Seal Material(s)	NBR (Buna-N®) <sup>2</sup>
Working Temperature	-30° C ... +106° C / -22° F ... +223° F
Valve Design	Poppet Valve
Connection	Push
Disconnection	Actuate Push Sleeve
Connect Under Pressure	Male Tip/Female Body
Application	Construction Machinery, Industrial Hydraulic
ISO Interchange	-



<sup>2</sup>Alternative seal materials are available on request.

### Technical Data

Series	BG	DN Zoll	DN metric ISO 4397	Q <sub>max</sub>		Working Pressure		Bursting Pressure Connected		Female Body		Male Tip		Spillage	
				l/min	US GPM	bar	PSI	bar	PSI	bar	PSI	bar	PSI	ml	fl oz
HUS-10	2	3/8"	10			350	5076	1500	21756	1450	21031	1500	21756		
HUS-12	3	1/2"	12,5			315	4569	1520	22046	1200	17405	1300	18855		
HUS-19	4	3/4"	19 (20)			300	4351	1250	18130	1200	17405	1250	181230		
HUS-25	6	1"	25			260	3771	1100	15954	1000	14504	1100	15954		

The indicated pressure ratings only apply to the coupling itself and depend on the connection type.

### Flow Characteristics

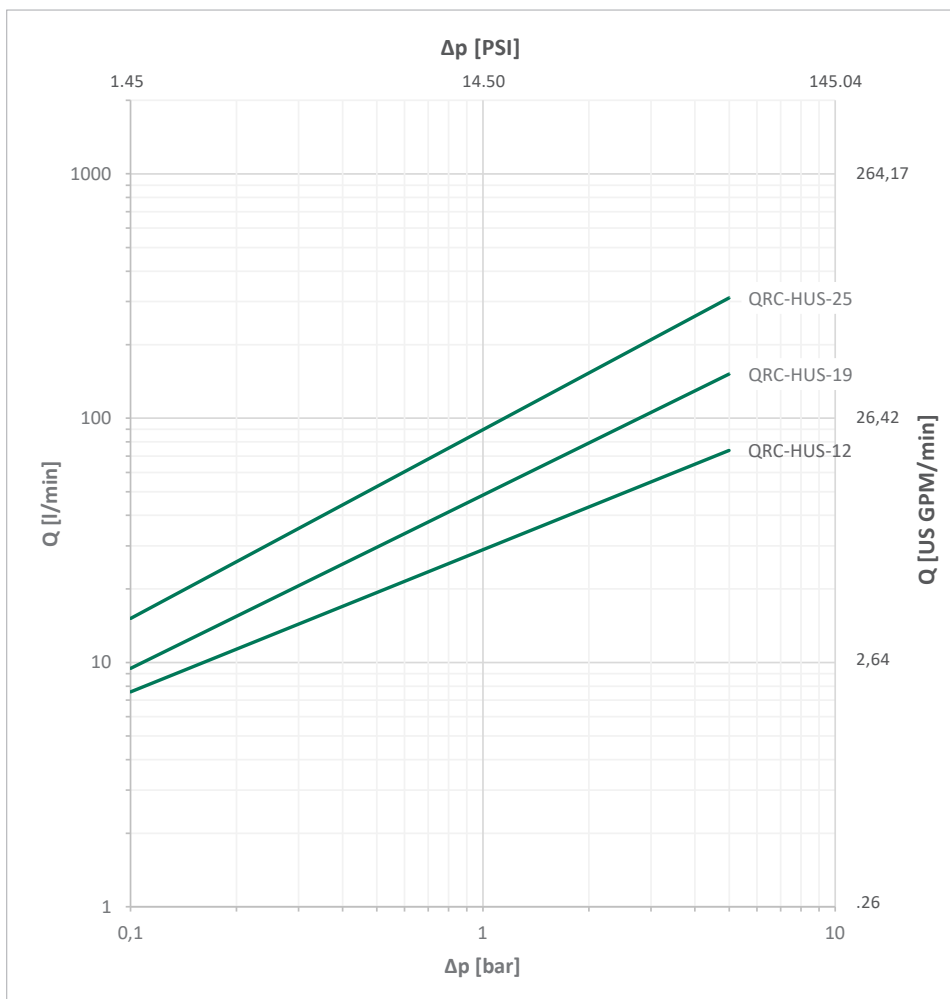

Please note: Unless otherwise stated, all flow characteristics have been determined with hydraulic oil with a kinematic viscosity of 28,8 - 35,2 mm<sup>2</sup>/s (28,8 - 35,2 cSt) and are only valid for components with non-reducing connections.





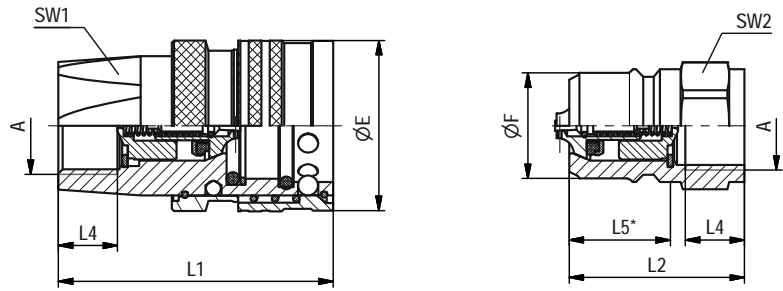

SW: Width across flats. All dimensions in mm (inch).

**Series HUS-10 • BG 2 • Nominal Size 10**

Port A	Dimensions ( <sup>mm</sup> / <sub>in</sub> )									Female Body Ordering Codes	Weight (*9 <sub>lbs</sub> ) ca. per 100	Male Tip Ordering Codes	Weight (*9 <sub>lbs</sub> ) ca. per 100
	ØE	ØF	L1	L2	L4 min	L5	SW1	SW2					
Female Thread according to DIN 3852 - ISO 1179-1 - ANSI B 1.20.3													
	G 3/8"	35	20	61,5	38	14	23	24	32	QRC-HUS-10-F-G06-BT-W3	22,47	QRC-HUS-10-M-G06-B-W3	6,00
		1,38	.79	2.42	1.50	.55	.91	.94	1.26		49.54		13.23

**Series HUS-12 • BG 3 • Nominal Size 12,5**

Port A	Dimensions ( <sup>mm</sup> / <sub>in</sub> )									Female Body Ordering Codes	Weight (*9 <sub>lbs</sub> ) ca. per 100	Male Tip Ordering Codes	Weight (*9 <sub>lbs</sub> ) ca. per 100
	ØE	ØF	L1	L2	L4 min	L5	SW1	SW2					
Female Thread according to DIN 3852 - ISO 1179-1 - ANSI B 1.20.3													
	G 1/2"	41	25	67,5	42,5	16	24,5	30	34	QRC-HUS-12-F-G08-BT-W3	31,77	QRC-HUS-12-M-G08-B-W3	10,55
		1,61	.98	2.66	1.67	.63	.96	1.18	1.34		70.04		23.26

**HUS**
**Series HUS-19 • BG 4 • Nominal Size 19**

Port A	Dimensions ( <sup>mm</sup> / <sub>in</sub> )									Female Body Ordering Codes	Weight (*9 <sub>lbs</sub> ) ca. per 100	Male Tip Ordering Codes	Weight (*9 <sub>lbs</sub> ) ca. per 100
	ØE	ØF	L1	L2	L4 min	L5	SW1	SW2					
Female Thread according to DIN 3852 - ISO 1179-1 - ANSI B 1.20.3													
	G 3/4"	52	33	76,4	47	19	29	38	46	QRC-HUS-19-F-G12-BT-W3	58,5	QRC-HUS-19-M-G12-B-W3	18,5
		2,05	1,30	3,01	1,85	.75	1,14	1,50	1,81		128,97		40,79

**Series HUS-25 • BG 6 • Nominal Size 25**

Port A	Dimensions ( <sup>mm</sup> / <sub>in</sub> )									Female Body Ordering Codes	Weight (*9 <sub>lbs</sub> ) ca. per 100	Male Tip Ordering Codes	Weight (*9 <sub>lbs</sub> ) ca. per 100
	ØE	ØF	L1	L2	L4 min	L5	SW1	SW2					
Female Thread according to DIN 3852 - ISO 1179-1 - ANSI B 1.20.3													
	G 1"	62	41	92	56,5	21	35	50	50	QRC-HUS-25-F-G16-BT-W3	93,9	QRC-HUS-25-M-G16-B-W3	33,9
		2,44	1,61	3,62	2,22	.83	1,38	1,97	1,97		207,01		74,74

Note: The connection of the two halves of a coupling is achieved depending on the type. It is important to observe the positive engagement of plug-type couplings and the secure tightening of screw-type couplings to the limit stop of the thread. Forced or improper separation will result in malfunction of the coupling.





Series MK

Series MK - Overview	108
Series MK-Q-10/4 - BG 2 - Nominal Size 10	109
Series MK-R-10/4 - BG 2 - Nominal Size 10	110

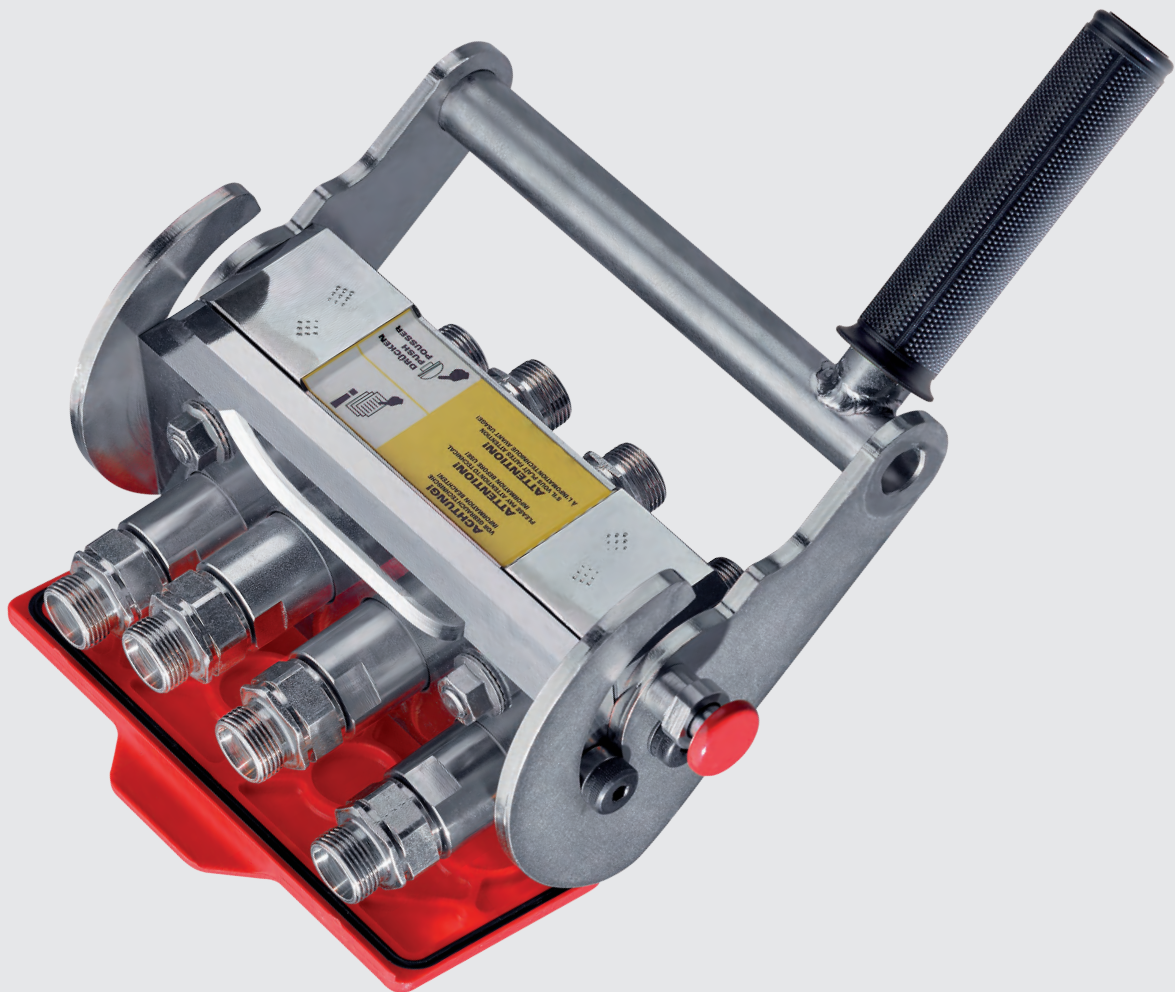

MK



## Series MK

### Description

The multi-coupling has been created for connecting and disconnecting several hydraulic lines at the same time. This is done by an operating lever the guide crank of which is designed for a minimum of operating force.

The connection of the hydraulic lines is done with flat face couplings. Due to the special sealing it is possible to couple against trapped pressure on the male halves (max. 4x100 bar / 4x1450 PSI)

The main features of the multi coupling are:

- Safety against commutability of hydraulic lines
- Quick connecting
- Coupling against trapped pressure
- Optimally minimized spillage during coupling process

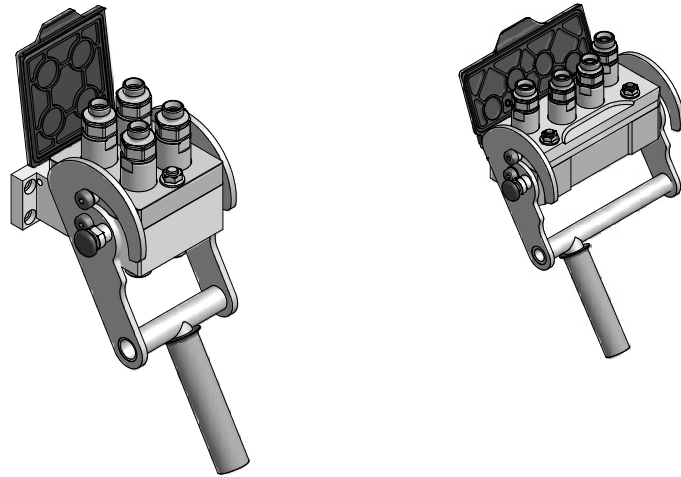

### Spare Parts

The following list shows the spare parts available for the line of the multi-coupling products. They are supplied in form of kits, including detailed removal and installation instructions:

Description	MK 24	MK 74
	Ordering Codes	Ordering Codes
Operating lever kit	QRC-MK-Q-10/4-SP-OL-W3	QRC-MK-R-10/4-SP-OL-W3
Safety lock kit	QRC-MK-Q-10/4-SP-SL-W3	QRC-MK-Q-10/4-SP-SL-W3
Dust protection kit	QRC-MK-Q-10/4-SP-DP-K	QRC-MK-R-10/4-SP-DP-K
Female coupling	QRC-EK-10-F-XXX-BT-W3	QRC-EK-10-F-XXX-BT-W3
Centering bolt kit	QRC-MK-Q-10/4-SP-CB-W3	QRC-MK-Q-10/4-SP-CB-W3
Guide screw kit	QRC-MK-Q-10/4-SP-GS-W4	QRC-MK-Q-10/4-SP-GS-W4
Male coupling	QRC-EK-10-M-XXX-BP-W3	QRC-EK-10-M-XXX-BP-W3
Seal kit (20 pcs.)	QRC-EK-10-MSK-PU	QRC-EK-10-MSK-PU

MK

Note: The connection of the two halves of a coupling is achieved depending on the type. It is important to observe the positive engagement of plug-type couplings and the secure tightening of screw-type couplings to the limit stop of the thread. Forced or improper separation will result in malfunction of the coupling.



**Working Pressure**

250 bar / 25 MPa / 3626 PSI (2 x 250 bar, 2 x 40 bar)

**Material**

Steel

**Surface Finishing**

Zinc-Nickel

**Standard Seal Material(s)**

NBR (Buna-N®), PTFE, PU

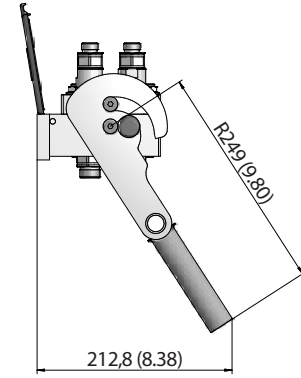
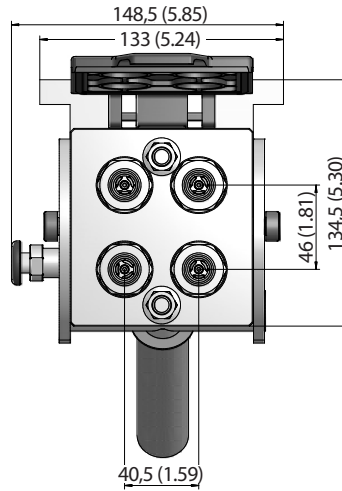

SW: Width across flats. All dimensions in mm (inch).

**Series MK-Q-10/4 24 · BG 2 · Nominal Size 10**

	Port A	Dimensions (mm/in)	Fixed half Ordering Codes	Weight (kg/lbs) ca. per 100	Mobile half Ordering Codes	Weight (kg/lbs) ca. per 100	Multicoupling System Ordering Codes	Weight (kg/lbs) ca. per 100
<b>Female Thread according to DIN 3852-2-A - ANSI B 1.20.3</b>								
	G 3/8"		QRC-MK-Q-10/4-FP-G06-BT-W3	581 1280.89	QRC-MK-Q-10/4-MP-G06-BP-W3	283 623.91	QRC-MK-Q-10/4-CC-G06-S1-W3	864 1904.79
	G 1/2"		QRC-MK-Q-10/4-FP-G08-BT-W3	581 1280.89	QRC-MK-Q-10/4-MP-G08-BP-W3	283 623.91	QRC-MK-Q-10/4-CC-G08-S1-W3	864 1904.79
	NPTF 1/2" - 14		QRC-MK-Q-10/4-FP-NF08-BT-W3	581 1280.89	QRC-MK-Q-10/4-MP-NF08-BP-W3	283 623.91	QRC-MK-Q-10/4-CC-NF08-S1-W3	864 1904.79
<b>Male Thread with 24° Conical Bore - Shape W according to DIN 3861</b>								
	M16x1,5	10L	QRC-MK-Q-10/4-FP-10L-BT-W3	557 1227.98	QRC-MK-Q-10/4-MP-10L-BP-W3	259 571.00	QRC-MK-Q-10/4-CC-10L-S1-W3	816 1798.97
	M18x1,5	12L	QRC-MK-Q-10/4-FP-12L-BT-W3	565 1245.61	QRC-MK-Q-10/4-MP-12L-BP-W3	259 571.00	QRC-MK-Q-10/4-CC-12L-S1-W3	824 1816.61
	M22x1,5	15L	QRC-MK-Q-10/4-FP-15L-BT-W3	565 1245.61	QRC-MK-Q-10/4-MP-15L-BP-W3	267 588.63	QRC-MK-Q-10/4-CC-15L-S1-W3	832 1834.25
	M26x1,5	18L	QRC-MK-Q-10/4-FP-18L-BT-W3	581 1280.89	QRC-MK-Q-10/4-MP-18L-BP-W3	267 588.63	QRC-MK-Q-10/4-CC-18L-S1-W3	848 1869.25

**MK**

Note: The connection of the two halves of a coupling is achieved depending on the type. It is important to observe the positive engagement of plug-type couplings and the secure tightening of screw-type couplings to the limit stop of the thread. Forced or improper separation will result in malfunction of the coupling.



**Working Pressure**

250 bar / 25 MPa / 3626 PSI (2 x 250 bar, 2 x 40 bar)

**Material**

Steel

**Surface Finishing**

Zinc-Nickel

**Standard Seal Material(s)**

NBR (Buna-N®), PTFE, PU

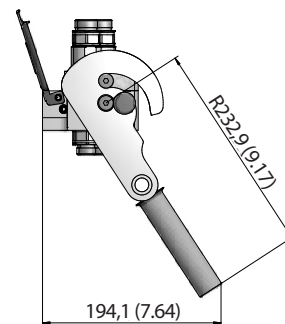
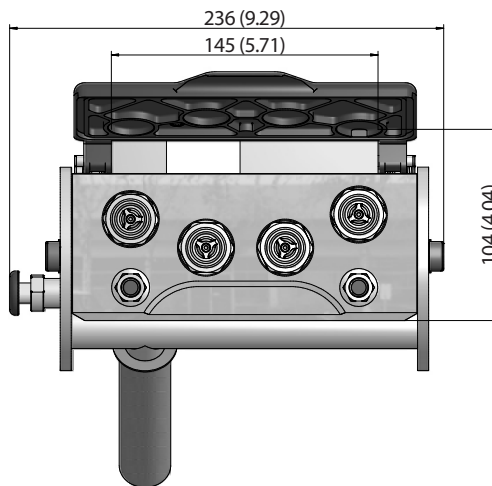

SW: Width across flats. All dimensions in mm (inch).

**Series MK-R-10/4 • BG 2 • Nominal Size 10**

Port A	Abmessung (mm/in)	Fixed half Ordering Codes	Weight ( <sup>kg</sup> /lbs) ca. per 100	Mobile half Ordering Codes	Weight ( <sup>kg</sup> /lbs) ca. per 100	Multicoupling System Ordering Codes	Weight ( <sup>kg</sup> /lbs) ca. per 100
Female Thread according to DIN 3852-2-A - ANSI B 1.20.3							
	G3/8"	QRC-MK-R-10/4-FP-G06-BT-W3	682 1503.55	QRC-MK-R-10/4-MP-G06-BP-W3	334 736.34	QRC-MK-R-10/4-CC-G06-S1-W3	1016 2239.90
	G 1/2"	QRC-MK-R-10/4-FP-G08-BT-W3	680 1499.14	QRC-MK-R-10/4-MP-G08-BP-W3	332 731.93	QRC-MK-R-10/4-CC-G08-S1-W3	1012 2231.08
	NPTF 1/2" - 14	QRC-MK-R-10/4-FP-NF08-BT-W3	678 1494.73	QRC-MK-R-10/4-MP-NF08-BP-W3	330 727.53	QRC-MK-R-10/4-CC-NF08-S1-W3	1008 2222.26
Male Thread with 24° Conical Bore - Shape W according to DIN 3861							
	M16x1,5	10L QRC-MK-R-10/4-FP-10L-BT-W3	669 1474.89	QRC-MK-R-10/4-MP-10L-BP-W3	321 707.68	QRC-MK-R-10/4-CC-10L-S1-W3	990 2182.58
	M18x1,5	12L QRC-MK-R-10/4-FP-12L-BT-W3	669 1474.89	QRC-MK-R-10/4-MP-12L-BP-W3	321 707.68	QRC-MK-R-10/4-CC-12L-S1-W3	990 2182.58
	M22x1,5	15L QRC-MK-R-10/4-FP-15L-BT-W3	672 1481.51	QRC-MK-R-10/4-MP-15L-BP-W3	324 714.30	QRC-MK-R-10/4-CC-15L-S1-W3	996 2195.80
	M26x1,5	18L QRC-MK-R-10/4-FP-18L-BT-W3	674 1485.92	QRC-MK-R-10/4-MP-18L-BP-W3	326 718.71	QRC-MK-R-10/4-CC-18L-S1-W3	1000 2204.62

MK

Note: The connection of the two halves of a coupling is achieved depending on the type. It is important to observe the positive engagement of plug-type couplings and the secure tightening of screw-type couplings to the limit stop of the thread. Forced or improper separation will result in malfunction of the coupling.



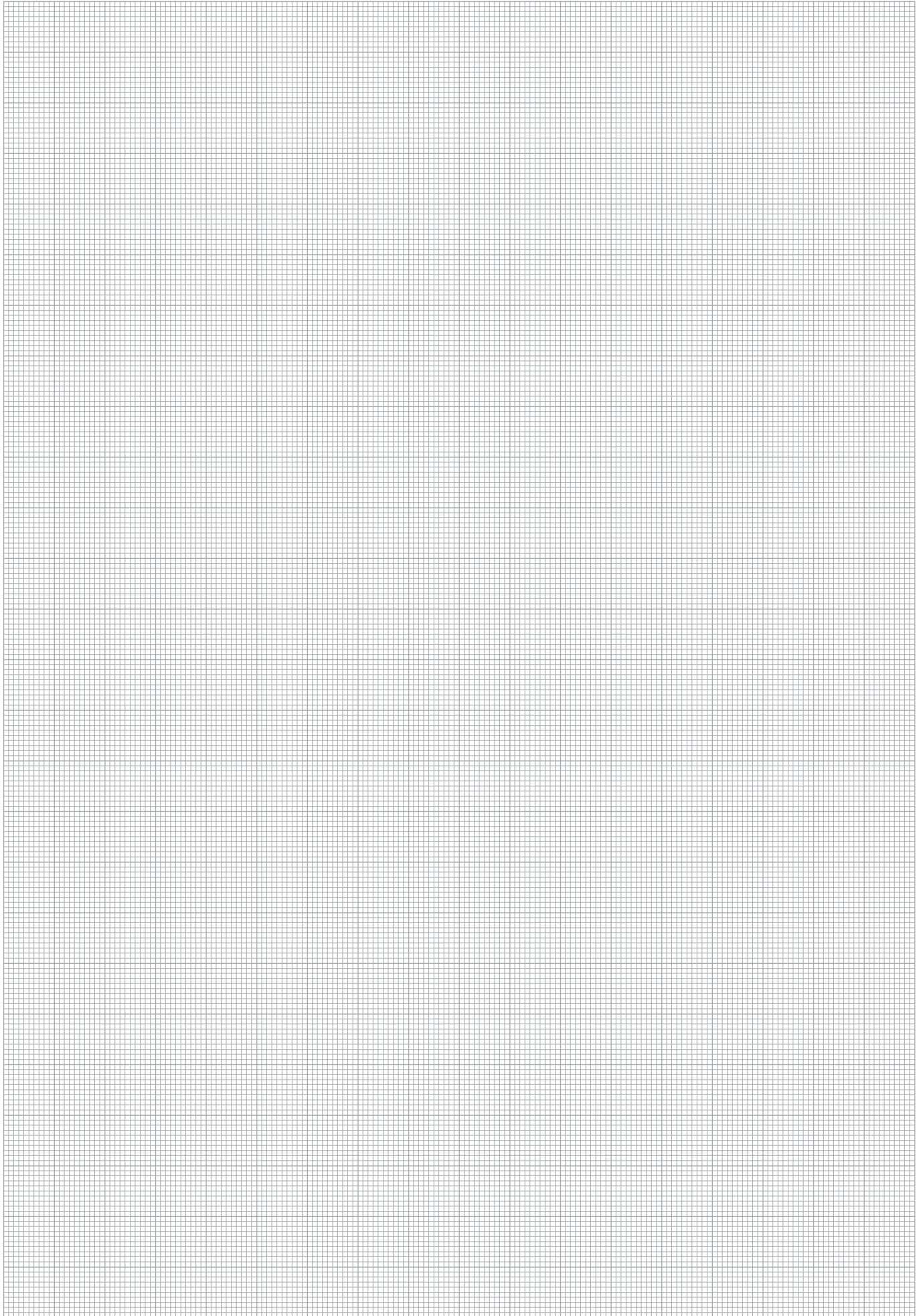

MK







Series HS - Carbon Steel

Series HS - Overview	114	Series HS-38 - BG 8 - Nominal Size 38	122
Series HS-06 - BG 1 - Nominal Size 6,3	115	Series HS - Dust Protection	123
Series HS-10 - BG 2 - Nominal Size 10	116		
Series HS-12 - BG 3 - Nominal Size 12,5	117-118		
Series HS-19 - BG 4 - Nominal Size 19	119		
Series HS-25 - BG 6 - Nominal Size 25	120		



HS



Series HS ▪ Carbon Steel

Material	Carbon Steel
Surface Finishing	Zinc-Plating and Thick-Film-Passivation (Chrome III)
Standard Seal Material(s)	NBR (Buna-N®) <sup>2</sup>
Working Temperature	-25° C ... +100° C / -13° F ... +212° F
Valve Design	Poppet Valve
Connection	Screw
Disconnection	Screw
Connect Under Pressure	Male Tip/Female Body up to 33% of the Working Pressure with Tools
Application	Construction Machinery
ISO Interchange	ISO 14541 (BG 1-6)



<sup>2</sup>Alternative seal materials are available on request.

Technical Data

Series	BG	DN Zoll Inch	DN metric ISO 4397	Q <sub>max</sub>		Working Pressure		Bursting Pressure Connected		Female Body		Male Tip		Spillage	
				l/min	US GPM	bar	PSI	bar	PSI	bar	PSI	bar	PSI	ml	fl oz
HS-06 ("...-HX")	1	1/4"	6,3	20	5.28	450	6527	1800	26107	1400	20305	1400	20305	0,8	.0271
HS-10	2	3/8"	10	40	10.57	450	6527	1600	23206	1750	25382	1550	22481	1,3	.0440
HS-12	3	1/2"	12,5	80	21.13	400	5802	1400	20305	1200	17405	1200	17405	3,1	.1048
HS-19	4	3/4"	19	120	31.70	400	5802	1500	21756	1600	23206	1200	17405	5,6	.1894
HS-25	6	1"	25	160	42.27	300	4351	1180	17114	1500	21756	1100	15954	12,3	.4159
HS-25-...-HX	6	1"	25	160	42.27	350	5076	1180	17114	1500	21756	1100	15954	12,3	.4159
HS-38	8	1 1/2"	38	220	58.12	350	5076	1800	26107	1600	23206	1200	17405	52,3	17.685

The indicated pressure ratings only apply to the coupling itself and depend on the connection type.

Flow Characteristics

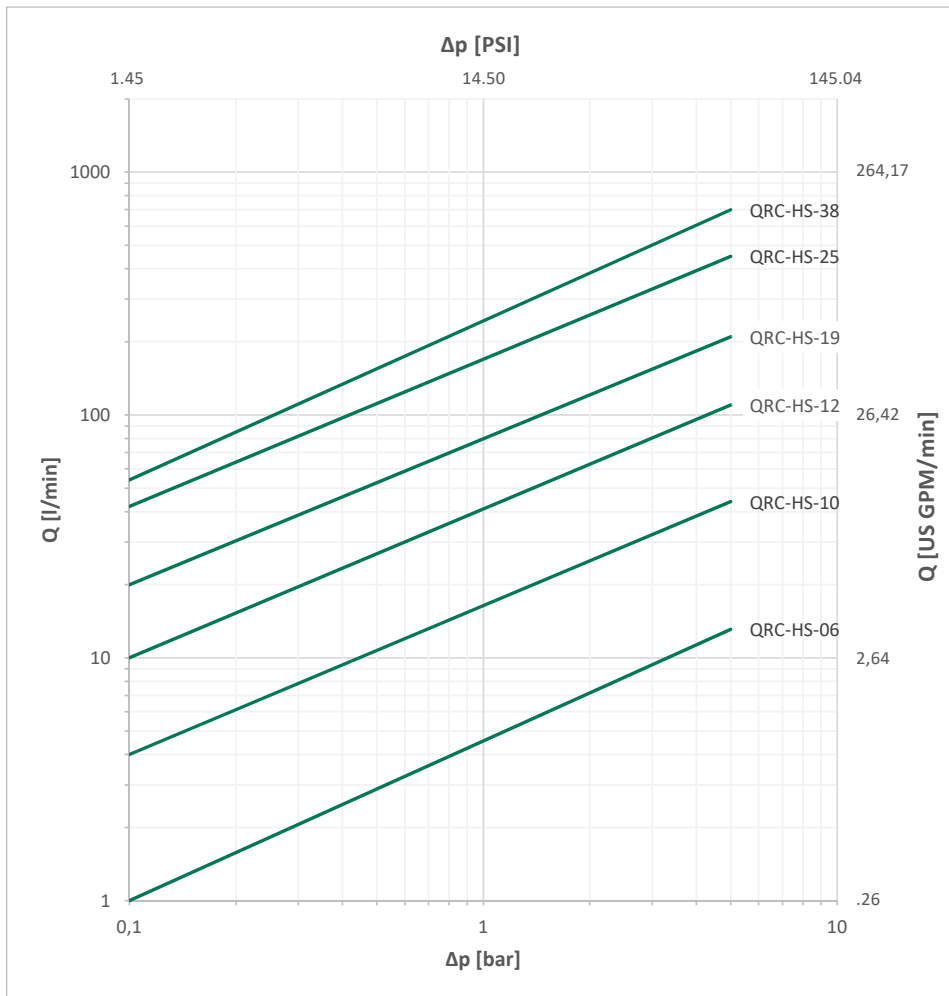

Please note: Unless otherwise stated, all flow characteristics have been determined with hydraulic oil with a kinematic viscosity of 28,8 - 35,2 mm<sup>2</sup>/s (28,8 - 35,2 cSt) and are only valid for components with non-reducing connections.



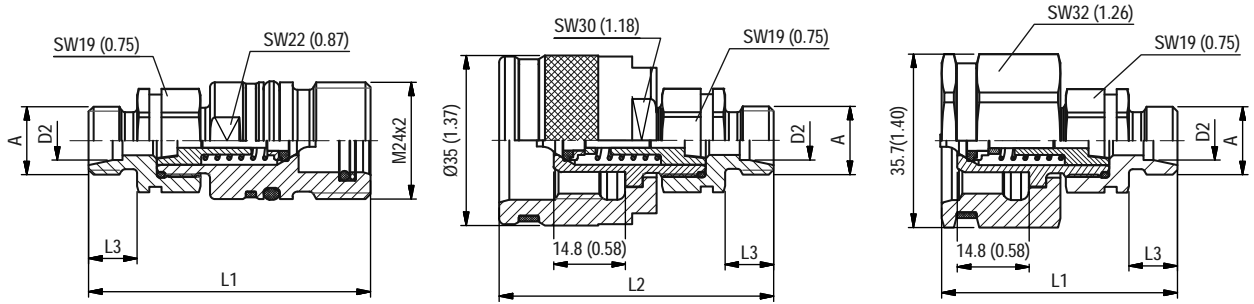

SW: Width across flats. All dimensions in mm (inch).

**Series HS-06 ▪ BG 1 ▪ Nominal Size 6,3**

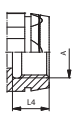
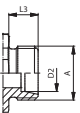
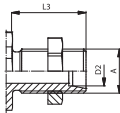
Port A	Dimensions ( <sup>mm</sup> / <sub>in</sub> )					Female Body Ordering Codes	Weight ( <sup>kg</sup> / <sub>lbs</sub> ) ca. per 100	Male Tip Ordering Codes	Weight ( <sup>kg</sup> / <sub>lbs</sub> ) ca. per 100
	ØD2	L1	L2	L3	L4				
<b>Female Thread according to DIN 3852-2-A - ANSI B 1.20.3</b>									
	G 1/4"	60 2.36	59 2.32		13 .51	QRC-HS-06-F-G04-BT-W66	12 26.46	QRC-HS-06-M-G04-BT-W66	18,20 40.12
	NPTF 1/4" -18	60 2.36	59 2.32				QRC-HS-06-F-NF04-BT-W66	12 26.46	QRC-HS-06-M-NF04-B-W66
<b>Male Thread with 24° Conical Bore - Shape W according to DIN 3861</b>									
	M14x1,5	8L	58 2.28	57 2.24	10 .39	QRC-HS-06-F-08L-BT-W66	12,10 26.68	QRC-HS-06-M-08L-B-W66	18,70 41.23
<b>Male Thread with 24° Conical Bore - Bulkhead - Shape W according to DIN 3861</b>									
	M14x1,5	8L	73 2.87	72 2.83	25 .98	QRC-HS-06-F-08LB-BT-W66	13,70 30.20	QRC-HS-06-M-08LB-B-W66	20,30 44.75

For the Version with Hexagonal Sleeve, please add "-HX" behind the Ordering Code.  
Available on request with a safety clamp.

**HS**

Note: The connection of the two halves of a coupling is achieved depending on the type. It is important to observe the positive engagement of plug-type couplings and the secure tightening of screw-type couplings to the limit stop of the thread. Forced or improper separation will result in malfunction of the coupling.



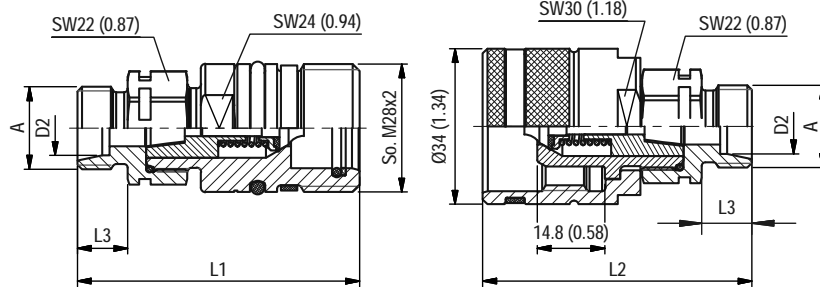

SW: Width across flats. All dimensions in mm (inch).

Series HS-10 • BG 2 • Nominal Size 10

Port A	Dimensions (mm/in)					Female Body	Weight (kg/lbs) ca. per 100	Male Tip	Weight (kg/lbs) ca. per 100
	ØD2	L1	L2	L3	L4				
<b>Male Thread according to DIN ISO 8434-1</b>									
	G 3/8"	65	62	12		QRC-HS-10-F-B06-BT-W66	16,90 37.26	QRC-HS-10-M-B06-B-W66	18,10 39.90
	UNF 3/4" -16	67	53	17		QRC-HS-10-F-J12-BT-W66	16 35.27	QRC-HS-10-M-J08-B-W66	17,50 38.58
<b>Female Thread according to DIN 3852-2-A - ISO 9974-1 - ANSI B 1.20.3</b>									
	G1/4"	64	61		13	QRC-HS-10-F-G04-BT-W66	18 39.68	QRC-HS-10-M-G04-B-W66	19,20 42.33
		G3/8"	64	61		13	QRC-HS-10-F-G06-BT-W66	17,20 37.92	QRC-HS-10-M-G06-B-W66
	M16x1,5	64	61		13	QRC-HS-10-F-M16-BT-W66	16,10 35.49	QRC-HS-10-M-M16-B-W66	17,40 38.36
		NPTF 3/8" -18	64	61			QRC-HS-10-F-NF06-BT-W66	17,30 38.14	QRC-HS-10-M-NF06-B-W66
<b>Male Thread with 24° Conical Bore - Shape W according to DIN 3861</b>									
	M14x1,5	8L	61	58	10	QRC-HS-10-F-08L-BT-W66	14,40 31.75	QRC-HS-10-M-08L-B-W66	15,80 34.83
		10L	62	59	11	QRC-HS-10-F-10L-BT-W66	15,80 34.83	QRC-HS-10-M-10L-B-W66	16,90 37.26
	M18x1,5	12L	62	59	11	QRC-HS-10-F-12L-BT-W66	16 35.27	QRC-HS-10-M-12L-B-W66	17,20 37.92
		8S	63	60	12	QRC-HS-10-F-08S-BT-W66	16,30 35.94	QRC-HS-10-M-08S-B-W66	17,40 38.36
	M18x1,5	10S	63	60	12	QRC-HS-10-F-10S-BT-W66	16,40 36.16	QRC-HS-10-M-10S-B-W66	17,60 38.80
		M20x1,5	12S	63	60	12	QRC-HS-10-F-12S-BT-W66	15,40 33.95	QRC-HS-10-M-12S-B-W66
<b>Male Thread with 24° Conical Bore - Bulkhead - Shape W according to DIN 3861</b>									
	M14x1,5	8L	76	73	25	QRC-HS-10-F-08LB-BT-W66	17,20 37.92	QRC-HS-10-M-08LB-B-W66	17,60 38.80
		10L	77	74	26	QRC-HS-10-F-10LB-BT-W66	18,70 41.23	QRC-HS-10-M-10LB-B-W66	17 37.48
	M22x1,5	15L	78	75	27	QRC-HS-10-F-15LB-BT-W66	23,10 50.93	QRC-HS-10-M-15LB-BT-W66	17,50 38.58
		08S	78	5	27	QRC-HS-10-F-08SB-BT-W66	16 35.27	QRC-HS-10-M-08SB-BT-W66	17 37.48
	M18x1,5	10S	78	75	27	QRC-HS-10-F-10SB-BT-W66	17,50 38.58	QRC-HS-10-M-10SB-B-W66	17,50 38.58
		M20x1,5	12S	78	75	27	QRC-HS-10-F-12SB-BT-W66	31 68.34	QRC-HS-10-M-12SB-B-W66

Available on request with a safety clamp and Hexagonal Sleeve.

Note: The connection of the two halves of a coupling is achieved depending on the type. It is important to observe the positive engagement of plug-type couplings and the secure tightening of screw-type couplings to the limit stop of the thread. Forced or improper separation will result in malfunction of the coupling.



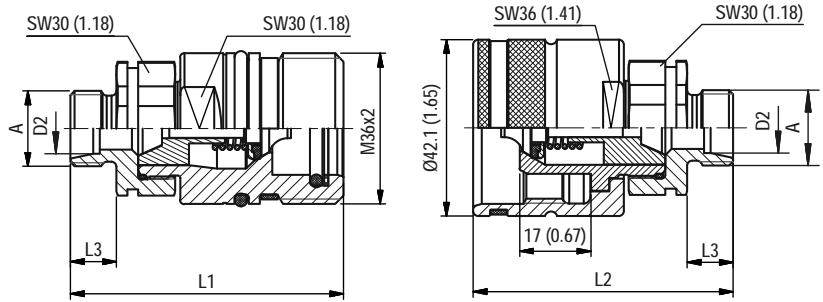

SW: Width across flats. All dimensions in mm (inch).

**Series HS-12 ▪ BG 3 ▪ Nominal Size 12,5**

Port A	Dimensions ( <sup>mm</sup> / <sub>in</sub> )					Female Body Ordering Codes	Weight ( <sup>kg</sup> / <sub>lbs</sub> ) ca. per 100	Male Tip Ordering Codes	Weight ( <sup>kg</sup> / <sub>lbs</sub> ) ca. per 100
	ØD2	L1	L2	L3	L4				
<b>Male Thread according to DIN 3852-2 - ISO 9974-3</b>									
	G 3/8"	69 2.72	66 2.60	12 .47		QRC-HS-12-F-B06-BT-W66	28,70 63.27	QRC-HS-12-M-B06-B-W66	26,70 58.86
	G 1/2"	69 2.72	66 2.60	12 .47		QRC-HS-12-F-B08-BT-W66	29,50 65.04	QRC-HS-12-M-B08-B-W66	27,10 59.75
	M22x1,5	69 2.72	66 2.60	12 .47		QRC-HS-12-F-M22M-BT-W66	29,60 65.26	QRC-HS-12-M-M22M-B-W66	26,20 57.76
<b>Female Thread according to DIN 3852-2-A - ISO 6149-1 - ANSI B 1.20.3 - SAE J1926-1 - ISO 11926-1</b>									
	G3/8"	67 2.64	64 2.52		15 .59	QRC-HS-12-F-G06-BT-W66	30,80 67.90	QRC-HS-12-M-G06-B-W66	28,80 63.49
		G1/2"	67 2.64	64 2.52		15 .59	QRC-HS-12-F-G08-BT-W66	31,90 70.33	QRC-HS-12-M-G08-B-W66
	M18x1,5		67 2.64	64 2.52		15 .59	QRC-HS-12-F-M180R-BT-W66	30,20 66.58	QRC-HS-12-M-M180R-B-W66
		M22x1,5	67 2.64	64 2.52		15 .59	QRC-HS-12-F-M220R-BT-W66	29,20 64.37	QRC-HS-12-M-M220R-B-W66
	NPTF 1/2" -14		70 2.76	67 2.64			QRC-HS-12-F-NF08-BT-W66	29,60 65.26	QRC-HS-12-M-NF08-B-W66
	UNF 7/8" -14	73 2.87	70 2.76		18 .71	QRC-HS-12-F-U10-BT-W66	29,20 64.37	QRC-HS-12-M-U10-B-W66	27 59.52

Available on request with a safety clamp and Hexagonal Sleeve.

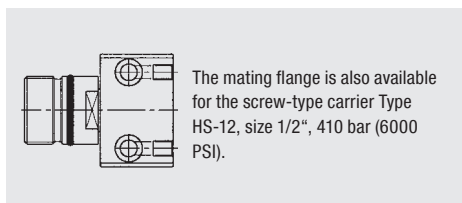
**HS**

Note: The connection of the two halves of a coupling is achieved depending on the type. It is important to observe the positive engagement of plug-type couplings and the secure tightening of screw-type couplings to the limit stop of the thread. Forced or improper separation will result in malfunction of the coupling.



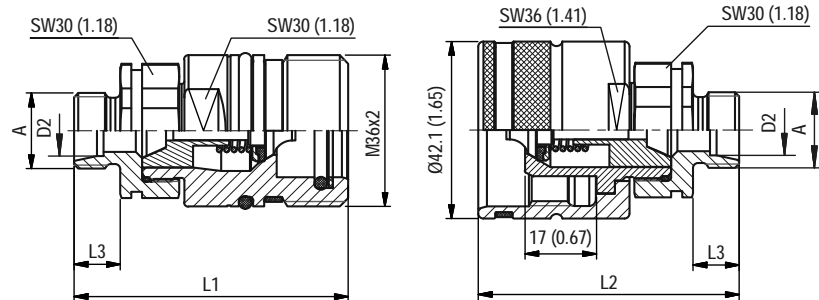

SW: Width across flats. All dimensions in mm (inch).

Series HS-12 • BG 3 • Nominal Size 12,5

	Port A	Dimensions (mm/in)				Female Body	Weight (kg/lbs) ca. per 100	Male Tip	Weight (kg/lbs) ca. per 100
		ØD2	L1	L2	L3				
<b>Male Thread with 24° Conical Bore - Shape W according to DIN 3861</b>									
	M14x1,5	8L	64 2.53	61 2.40	10 .39	QRC-HS-12-F-08L-BT-W66	26,40 58.20	QRC-HS-12-M-08L-B-W66	25,40 56.00
	M16x1,5	10L	65	62	11	QRC-HS-12-F-10L-BT-W66	27,70	QRC-HS-12-M-10L-B-W66	25,70
			2.57	2.44	.43	61.07	56.66		
	M18x1,5	12L	65	62	11	QRC-HS-12-F-12L-BT-W66	27,80	QRC-HS-12-M-12L-B-W66	25,80
			2.57	2.44	.43	61.29	56.88		
	M22x1,5	15L	66	63	12	QRC-HS-12-F-15L-BT-W66	28,40	QRC-HS-12-M-15L-B-W66	26,40
			2.61	2.48	.47	62.61	58.20		
	M26x1,5	18L	66	63	12	QRC-HS-12-F-18L-BT-W66	28,40	QRC-HS-12-M-18L-B-W66	26,40
			2.61	2.48	.47	62.61	58.20		
	M18x1,5	10S	66	63	12	QRC-HS-12-F-10S-BT-W66	28,40	QRC-HS-12-M-10S-B-W66	26,40
			2.61	2.48	.47	62.61	58.20		
M20x1,5	12S	66	63	12	QRC-HS-12-F-12S-BT-W66	28,40	QRC-HS-12-M-12S-B-W66	26,40	
		2.61	2.48	.47	62.61	58.20			
M22x1,5	14S	68	65	14	QRC-HS-12-F-14S-BT-W66	29,20	QRC-HS-12-M-14S-B-W66	27,20	
		2.69	2.56	.55	64.37	59.97			
M24x1,5	16S	68	65	14	QRC-HS-12-F-16S-BT-W66	29,20	QRC-HS-12-M-16S-B-W66	27,20	
		2.69	2.56	.55	64.37	59.97			
M30x2	20S	70	67	16	QRC-HS-12-F-20S-BT-W66	28,40	QRC-HS-12-M-20S-B-W66	25,70	
		2.76	2.64	.63	62.61	56.66			
<b>Male Thread with 24° Conical Bore - Bulkhead - Shape W according to DIN 3861</b>									
	M14x1,5	08L	80	77	26	QRC-HS-12-F-08LB-BT-W66	28,60	QRC-HS-12-M-08LB-B-W66	26,20
			3.16	3.03	1.02	63.05	57.76		
	M16x1,5	10L	80	77	26	QRC-HS-12-F-10LB-BT-W66	30,70	QRC-HS-12-M-10LB-B-W66	27,50
			3.16	3.03	1.02	67.68	60.63		
	M18x1,5	12L	84	81	30	QRC-HS-12-F-12LB-BT-W66	30,60	QRC-HS-12-M-12LB-B-W66	26,80
			3.31	3.19	1.18	67.46	59.08		
	M22x1,5	15L	81	78	27	QRC-HS-12-F-15LB-BT-W66	31,40	QRC-HS-12-M-15LB-B-W66	28,20
			3.20	3.07	1.06	69.23	62.17		
	M26x1,5	18L	81	78	27	QRC-HS-12-F-18LB-BT-W66	36,60	QRC-HS-12-M-18LB-B-W66	34,60
			3.20	3.07	1.06	80.69	76.28		
	M18x1,5	10S	80	77	26	QRC-HS-12-F-10SB-BT-W66	30,70	QRC-HS-12-M-10SB-B-W66	28
3.16			3.03	1.02	67.68	61.73			
M20x1,5	12S	81	78	27	QRC-HS-12-F-12SB-BT-W66	31,20	QRC-HS-12-M-12SB-B-W66	28,80	
		3.20	3.07	1.06	68.78	63.49			
M22x1,5	14S	83	80	29	QRC-HS-12-F-14SB-BT-W66	32,80	QRC-HS-12-M-14SB-B-W66	30,40	
		3.28	3.15	1.14	72.31	67.02			
M24x1,5	16S	83	80	29	QRC-HS-12-F-16SB-BT-W66	34,20	QRC-HS-12-M-16SB-B-W66	31,60	
		3.28	3.15	1.14	75.40	69.67			

Available on request with a safety clamp and Hexagonal Sleeve.

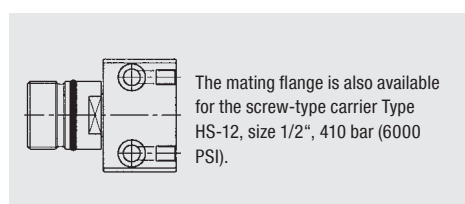

Note: The connection of the two halves of a coupling is achieved depending on the type. It is important to observe the positive engagement of plug-type couplings and the secure tightening of screw-type couplings to the limit stop of the thread. Forced or improper separation will result in malfunction of the coupling.



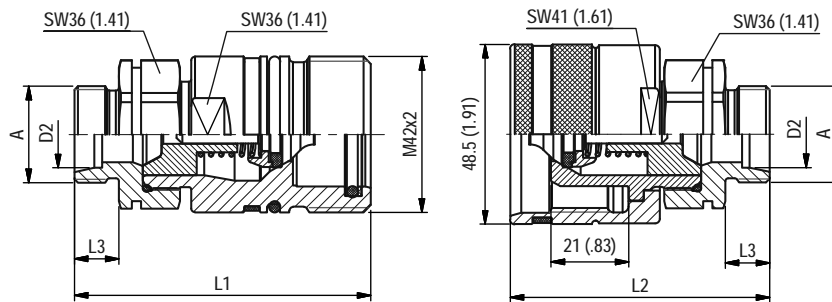

SW: Width across flats. All dimensions in mm (inch).

**Series HS-19 • BG 4 • Nominal Size 19**

Port A	Dimensions ( <sup>mm</sup> / <sub>in</sub> )					Female Body Ordering Codes	Weight ( <sup>kg</sup> / <sub>lbs</sub> ) ca. per 100	Male Tip Ordering Codes	Weight ( <sup>kg</sup> / <sub>lbs</sub> ) ca. per 100
	ØD2	L1	L2	L3	L4				
<b>Female Thread according to DIN 3852-2-A - ISO 9974-1 - ANSI B 1.20.3</b>									
	G1/2"	86 3.39	75 2.95		19 .75	QRC-HS-19-F-G08-BT-W66	52,60 115.96	QRC-HS-19-M-G08-B-W66	50,40 111.11
	G3/4"	86 3.39	75 2.95		19 .75	QRC-HS-19-F-G12-BT-W66	63,60 140.21	QRC-HS-19-M-G12-B-W66	47,60 104.94
	M22x1,5	86 3.39	75 2.95		19 .75	QRC-HS-19-F-M22-BT-W66	55 121.25	QRC-HS-19-M-M22-B-W66	49 108.03
	NPTF 3/4" -14	86 3.39	75 2.95			QRC-HS-19-F-NF12-BT-W66	55 121.25	QRC-HS-19-M-NF12-B-W66	47,60 104.94
<b>Male Thread with 24° Conical Bore - Shape W according to DIN 3861</b>									
	M18x1,5	12L	79 3.11	69 2.72	11 .43	QRC-HS-19-F-12L-BT-W66	46 101.41	QRC-HS-19-M-12L-B-W66	40,80 89.95
		15L	80 3.15	70 2.76	12 .47	QRC-HS-19-F-15L-BT-W66	46,60 102.74	QRC-HS-19-M-15L-B-W66	41,30 91.05
	M26x1,5	18L	80 3.15	70 2.76	12 .47	QRC-HS-19-F-18L-BT-W66	47,90 105.60	QRC-HS-19-M-18L-B-W66	41,90 92.37
		22L	82 3.23	72 2.83	14 .55	QRC-HS-19-F-22L-BT-W66	49,20 108.47	QRC-HS-19-M-22L-B-W66	43,10 95.02
	M24x1,5	16S	82 3.23	72 2.83	14 .55	QRC-HS-19-F-16S-BT-W66	47,40 104.50	QRC-HS-19-M-16S-B-W66	40,20 88.63
		20S	84 3.31	74 2.91	16 .63	QRC-HS-19-F-20S-BT-W66	50 110.23	QRC-HS-19-M-20S-B-W66	44 97
<b>Male Thread with 24° Conical Bore - Bulkhead - Shape W according to DIN 3861</b>									
	M18x1,5	12L	94 3.70	84 3.31	26 1.02	QRC-HS-19-F-12LB-BT-W66	48,80 107.59	QRC-HS-19-M-12LB-B-W66	42,20 93.04
		15L	95 3.74	85 3.35	27 1.06	QRC-HS-19-F-15LB-BT-W66	51 112.44	QRC-HS-19-M-15LB-B-W66	43,80 96.56
	M26x1,5	18L	95 3.74	85 3.35	27 1.06	QRC-HS-19-F-18LB-BT-W66	55,70 122.80	QRC-HS-19-M-18LB-B-W66	47,50 104.72
		22L	104 4.09	94 3.70	36 1.42	QRC-HS-19-F-22LB-BT-W66	59,40 130.95	QRC-HS-19-M-22LB-B-W66	52,40 115.52
	M24x1,5	16S	97 3.82	87 3.43	29 1.14	QRC-HS-19-F-16SB-BT-W66	53,40 117.73	QRC-HS-19-M-16SB-B-W66	46,20 101.85
		20S	104 4.09	94 3.70	36 1.42	QRC-HS-19-F-20SB-BT-W66	62,40 137.57	QRC-HS-19-M-20SB-B-W66	56,50 124.56

Available on request with a safety clamp and Hexagonal Sleeve.

**HS**

Note: The connection of the two halves of a coupling is achieved depending on the type. It is important to observe the positive engagement of plug-type couplings and the secure tightening of screw-type couplings to the limit stop of the thread. Forced or improper separation will result in malfunction of the coupling.



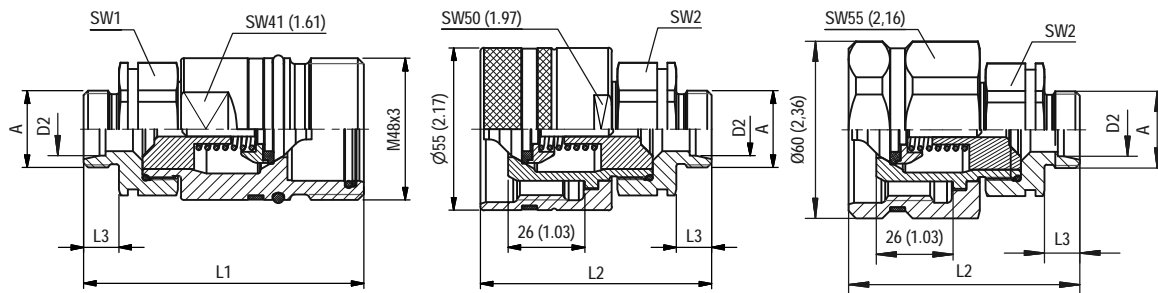

SW: Width across flats. All dimensions in mm (inch).

Series HS-25 • BG 6 • Nominal Size 25

Port A	Dimensions (mm/in)						Female Body	Weight (kg/lbs) ca. per 100	Male Tip	Weight (kg/lbs) ca. per 100		
	ØD2	L1	L2	L3	L4	SW1 SW2					Ordering Codes	Ordering Codes
Female Thread according to DIN 3852-2-A - ANSI B 1.20.3												
	G3/4"	98	81		19	41	41	QRC-HS-25-F-G12-BT-W66	78,10	QRC-HS-25-M-G12-B-W66	68,80	
		3.86	3.19		.75	1.61	1.61		172.18		151.68	
	G1"	98	81		19	41	41	QRC-HS-25-F-G16-BT-W66	73,80	QRC-HS-25-M-G16-B-W66	64,50	
		3.86	3.19		.75	1.61	1.61		162.70		142.20	
NPTF 1" -11 1/2	98	81				41	41	QRC-HS-25-F-NF16-BT-W66	78	QRC-HS-25-M-NF16-B-W66	60,10	
		3.86	3.19			1.61	1.61		171.96		132.50	
Male Thread with 24° Conical Bore - Shape W according to DIN 3861												
	M26x1,5	18L	95	78	12		41	41	QRC-HS-25-F-18L-BT-W66	70,90	QRC-HS-25-M-18L-B-W66	61,60
			3.74	3.07	.47		1.61	1.61		156.31		135.80
	M30x2	22L	97	80	14		41	41	QRC-HS-25-F-22L-BT-W66	71,50	QRC-HS-25-M-22L-B-W66	62,20
			3.82	3.15	.55		1.61	1.61		157.63		137.13
	M36x2	28L	97	80	14		41	41	QRC-HS-25-F-28L-BT-W66	72	QRC-HS-25-M-28L-B-W66	67,20
			3.82	3.15	.55		1.61	1.61		158.73		148.15
	M45x2	35L	99	82	16		46	46	QRC-HS-25-F-35L-BT-W66	80,50	QRC-HS-25-M-35L-B-W66	71,30
			3.90	3.23	.63		1.81	1.81		177.47		157.19
	M30x2	20S	99	82	16		41	41	QRC-HS-25-F-20S-BT-W66	73,10	QRC-HS-25-M-20S-B-W66	63,90
		3.90	3.23	.63		1.61	1.61		161.16		140.88	
M36x2	25S	101	84	18		41	41	QRC-HS-25-F-25S-BT-W66	75,30	QRC-HS-25-M-25S-B-W66	66	
		3.98	3.31	.71		1.61	1.61		166.01		145.51	
M42x2	30S	103	86	20		41	41	QRC-HS-25-F-30S-BT-W66	87,10	QRC-HS-25-M-30S-B-W66	65	
		4.06	3.39	.79		1.61	1.61		192.02		143.30	
M52x2	38S	105	88	22		55	55	QRC-HS-25-F-38S-BT-W66	108	QRC-HS-25-M-38S-B-W66	90,10	
		4.13	3.46	.87		2.17	2.17		238.10		198.64	
Male Thread with 24° Conical Bore - Bulkhead - Shape W according to DIN 3861												
	M22x1,5	15L	110	93	27		41	41	QRC-HS-25-F-15LB-BT-W66	82	QRC-HS-25-M-15LB-B-W66	62
			4.33	3.66	1.06		1.61	1.61		180.78		136.69
	M26x1,5	18L	115	98	32		41	41	QRC-HS-25-F-18LB-BT-W66	76,60	QRC-HS-25-M-18LB-B-W66	63,80
			4.53	3.86	1.26		1.61	1.61		168.87		140.65
	M30x2	22L	117	100	34		41	41	QRC-HS-25-F-22LB-BT-W66	86,10	QRC-HS-25-M-22LB-B-W66	65
			4.61	3.94	1.34		1.61	1.61		189.82		143.30
	M36x2	28L	117	100	34		41	41	QRC-HS-25-F-28LB-BT-W66	89,90	QRC-HS-25-M-28LB-B-W66	69
			4.61	3.94	1.34		1.61	1.61		198.20		152.12
	M30x2	20S	121	104	38		41	41	QRC-HS-25-F-20SB-BT-W66	94	QRC-HS-25-M-20SB-B-W66	70,60
		4.76	4.09	1.50		1.61	1.61		207.23		155.65	
M36x2	25S	121	104	38		41	41	QRC-HS-25-F-25SB-BT-W66	94,70	QRC-HS-25-M-25SB-B-W66	74	
		4.76	4.09	1.50		1.61	1.61		208.78		163.14	
M42x2	30S	123	106	40		46	46	QRC-HS-25-F-30SB-BT-W66	104	QRC-HS-25-M-30SB-B-W66	85	
		4.84	4.17	1.57		1.81	1.81		229.28		187.39	
M52x2	38S	123	106	40		55	55	QRC-HS-25-F-38SB-BT-W66	140,40	QRC-HS-25-M-38SB-B-W66	85	
		4.84	4.17	1.57		2.17	2.17		309.53		187.39	

For the Version with Hexagonal Sleeve, please add "-HX" behind the Ordering Code. Available on request with a safety clamp.

Note: The connection of the two halves of a coupling is achieved depending on the type. It is important to observe the positive engagement of plug-type couplings and the secure tightening of screw-type couplings to the limit stop of the thread. Forced or improper separation will result in malfunction of the coupling.





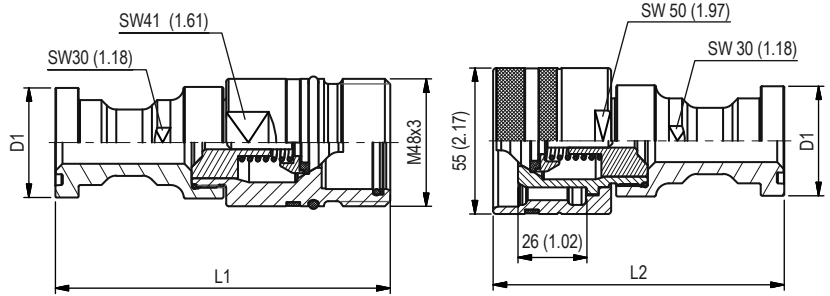

SW: Width across flats. All dimensions in mm (inch).

**Series HS-25 ▪ BG 6 ▪ Nominal Size 25**

Flange	Dimensions ( <sup>mm</sup> / <sub>in</sub> )						Female Body Ordering Codes	Weight ( <sup>kg</sup> / <sub>lbs</sub> ) ca. per 100	Male Tip Ordering Codes	Weight ( <sup>kg</sup> / <sub>lbs</sub> ) ca. per 100
	ØD1	L1	L2	L3	L4	L5				
3/4"	41,3	127 1.63	110 5.00				QRC-HS-25-F-F612-BT-W66	85,20 187.83	QRC-HS-25-M-F612-B-W66	76 167.55
1"	47,6	129 1.87	112 5.08				QRC-HS-25-F-F616-BT-W66	93,20 205.47	QRC-HS-25-M-F616-B-W66	83,90 184.97

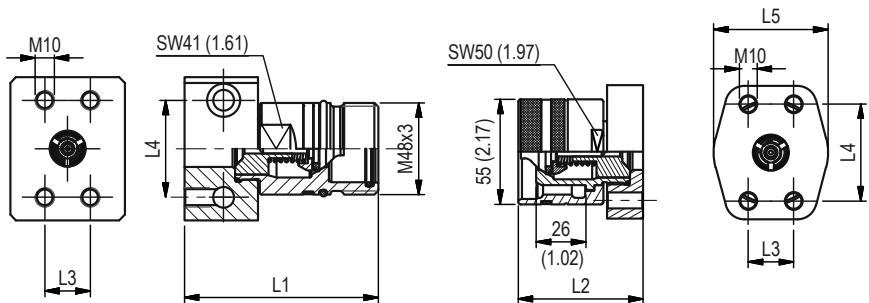

SW: Width across flats. All dimensions in mm (inch).

Flange	Dimensions ( <sup>mm</sup> / <sub>in</sub> )						Female Body Ordering Codes	Weight ( <sup>kg</sup> / <sub>lbs</sub> ) ca. per 100	Male Tip Ordering Codes	Weight ( <sup>kg</sup> / <sub>lbs</sub> ) ca. per 100
	ØD2	L1	L2	L3	L4	L5				
3/4"		102 4.02	65 2.56	23,8 .94	50,8 2.00	60 2.36	QRC-HS-25-F-C612M-B-W66-700514	163,10 359.57	QRC-HS-25-M-C612M-B-W66	87,70 193.35

**HS**

Note: The connection of the two halves of a coupling is achieved depending on the type. It is important to observe the positive engagement of plug-type couplings and the secure tightening of screw-type couplings to the limit stop of the thread. Forced or improper separation will result in malfunction of the coupling.



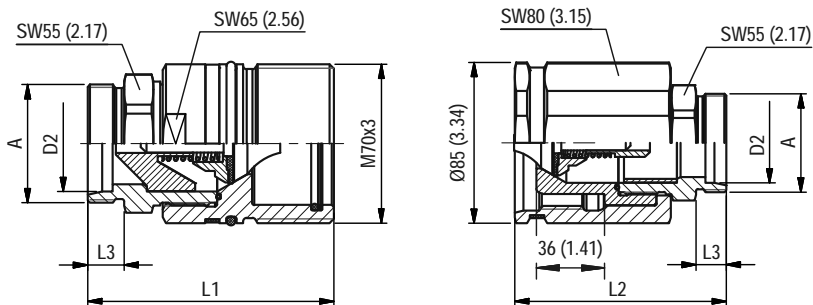

SW: Width across flats. All dimensions in mm (inch).

Series HS-38 • BG 8 • Nominal Size 38

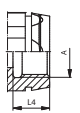
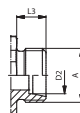
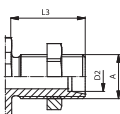
Port A	Dimensions (mm/in)					Female Body	Weight (kg/lbs) ca. per 100	Male Tip	Weight (kg/lbs) ca. per 100
	ØD2	L1	L2	L3	L4				
<b>Female Thread according to DIN 3852-2-A / Innengewinde DIN 3852-2-A</b>									
	G 1" 1/4	125 4.92	131 5.16		29 1.14	QRC-HS-38-F-G20-BT-W66	190,70 420.42	QRC-HS-38-M-G20-B-W66	276,60 609.80
	G 1" 1/2	127 5.00	134 5.28		31 1.22	QRC-HS-38-F-G24-BT-W66	184,90 407.63	QRC-HS-38-M-G24-B-W66	270,80 597.01
<b>Male Thread with 24° Conical Bore - Shape W according to DIN 3861</b>									
	M45x2	35L	105 4.11	112 4.39	16 .63	QRC-HS-38-F-35L-BT-W66	156 343.92	QRC-HS-38-M-35L-B-W66	209 460.77
	M52x2	42L	105 4.11	112 4.39	16 .63	QRC-HS-38-F-42L-BT-W66	162 357.15	QRC-HS-38-M-42L-B-W66	215 473.99
	M42x2	30S	112 4.41	119 4.69	20 .79	QRC-HS-38-F-30S-BT-W66	157,20 346.57	QRC-HS-38-M-30S-B-W66	209,20 461.21
	M52x2	38S	112 4.41	118 4.65	22 .87	QRC-HS-38-F-38S-BT-W66	162,40 358.03	QRC-HS-38-M-38S-B-W66	215,30 474.66
<b>Male Thread with 24° Conical Bore - Bulkhead - Shape W according to DIN 3861</b>									
	M45x2	35L	125 4.90	132 5.18	36 1.42	QRC-HS-38-F-35LB-BT-W66	173 381.40	QRC-HS-38-M-35LB-B-W66	234 515.88
	M52x2	42L	129 5.08	132 5.20	36 1.42	QRC-HS-38-F-42LB-BT-W66	172,50 380.30	QRC-HS-38-M-42LB-B-W66	233,50 514.78
	M42x2	30S	133 5.24	140 5.51	40 1.57	QRC-HS-38-F-30SB-BT-W66	182,40 402.12	QRC-HS-38-M-30SB-B-W66	268,30 591.50
	M52x2	38S	132 5.20	139 5.47	40 1.57	QRC-HS-38-F-38SB-BT-W66	173 381.40	QRC-HS-38-M-38SB-B-W66	279,30 615.75

Available on request with a safety clamp.

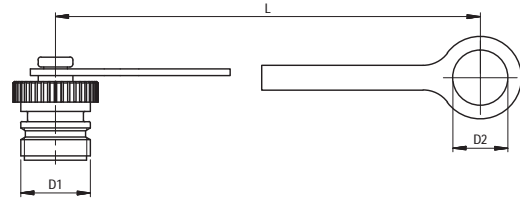
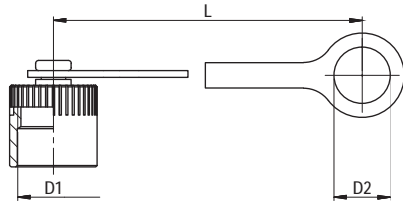

HS

**Series HS - Dust Protection**

Dimensions (mm/in)			Material	Dust Cap for Female Body
D1	D2	L		Ordering Codes
M24x2	19 .75	180 7.09	Plastic (Colour: Red)	<b>QRC-HS-06-DF-19-K-RD</b>
M28x2	23 .91	180 7.09	Plastic (Colour: Red)	<b>QRC-HS-10-DF-23-K-RD</b>
M36x2	29,5 1.16	185 7.28	Plastic (Colour: Red)	<b>QRC-HS-12-DF-30-K-RD</b>
M42x2	36,5 1.44	190 7.48	Plastic (Colour: Red)	<b>QRC-HS-19-DF-37-K-RD</b>
M48x3	41 1.61	190 7.48	Plastic (Colour: Red)	<b>QRC-HS-25-DF-41-K-RD</b>
M70x3	55 2.17	201 7.91	Plastic (Colour: Red)	<b>QRC-HS-38-DF-55-K-RD</b>

Dimensions (mm/in)			Material	Dust Plug for Male Tip
D1	D2	L		Ordering Codes
M24x2	19 .75	180 7.09	Plastic (Colour: Red)	<b>QRC-HS-06-DM-19-K-RD</b>
M28x2	23 .91	180 7.09	Plastic (Colour: Red)	<b>QRC-HS-10-DM-23-K-RD</b>
M36x2	29,5 1.16	185 7.28	Plastic (Colour: Red)	<b>QRC-HS-12-DM-30-K-RD</b>
M42x2	36,5 1.44	190 7.48	Plastic (Colour: Red)	<b>QRC-HS-19-DM-37-K-RD</b>
M48x3	41 1.61	190 7.48	Plastic (Colour: Red)	<b>QRC-HS-25-DM-41-K-RD</b>
M70x3	55 2.17	201 7.91	Plastic (Colour: Red)	<b>QRC-HS-38-DM-55-K-RD</b>

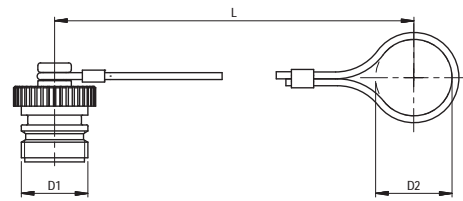
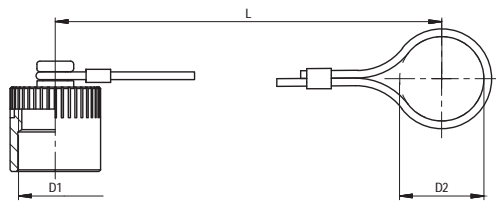

Dimensions (mm/in)			Material	Dust Cap for Female Body
D1	D2	L		Ordering Codes
M24x2			Aluminium with steel cable	<b>QRC-HS-06-DF-19-W89-SI</b>
M28x2			Aluminium with steel cable	<b>QRC-HS-10-DF-23-W89-SI</b>
M36x2			Aluminium with steel cable	<b>QRC-HS-12-DF-30-W89-SI</b>
M42x2			Aluminium with steel cable	<b>QRC-HS-19-DF-37-W89-SI</b>
M48x3			Aluminium with steel cable	<b>QRC-HS-25-DF-41-W89-SI</b>
M70x3			Aluminium with steel cable	<b>QRC-HS-38-DF-55-W89-SI</b>

Dimensions (mm/in)			Material	Dust Plug for Male Tip
D1	D2	L		Ordering Codes
M24x2			Aluminium with steel cable	<b>QRC-HS-06-DM-19-W89-SI</b>
M28x2			Aluminium with steel cable	<b>QRC-HS-10-DM-23-W89-SI</b>
M36x2			Aluminium with steel cable	<b>QRC-HS-12-DM-30-W89-SI</b>
M42x2			Aluminium with steel cable	<b>QRC-HS-19-DM-37-W89-SI</b>
M48x3			Aluminium with steel cable	<b>QRC-HS-25-DM-41-W89-SI</b>
M70x3			Aluminium with steel cable	<b>QRC-HS-38-DM-55-W89-SI</b>

In addition to the standard colours as stated above, plastic dust caps are also available in blue, green, yellow and black. Please use the color codes BU, GN, YE and BK respectively instead of RD.

**HS**

Note: The connection of the two halves of a coupling is achieved depending on the type. It is important to observe the positive engagement of plug-type couplings and the secure tightening of screw-type couplings to the limit stop of the thread. Forced or improper separation will result in malfunction of the coupling.



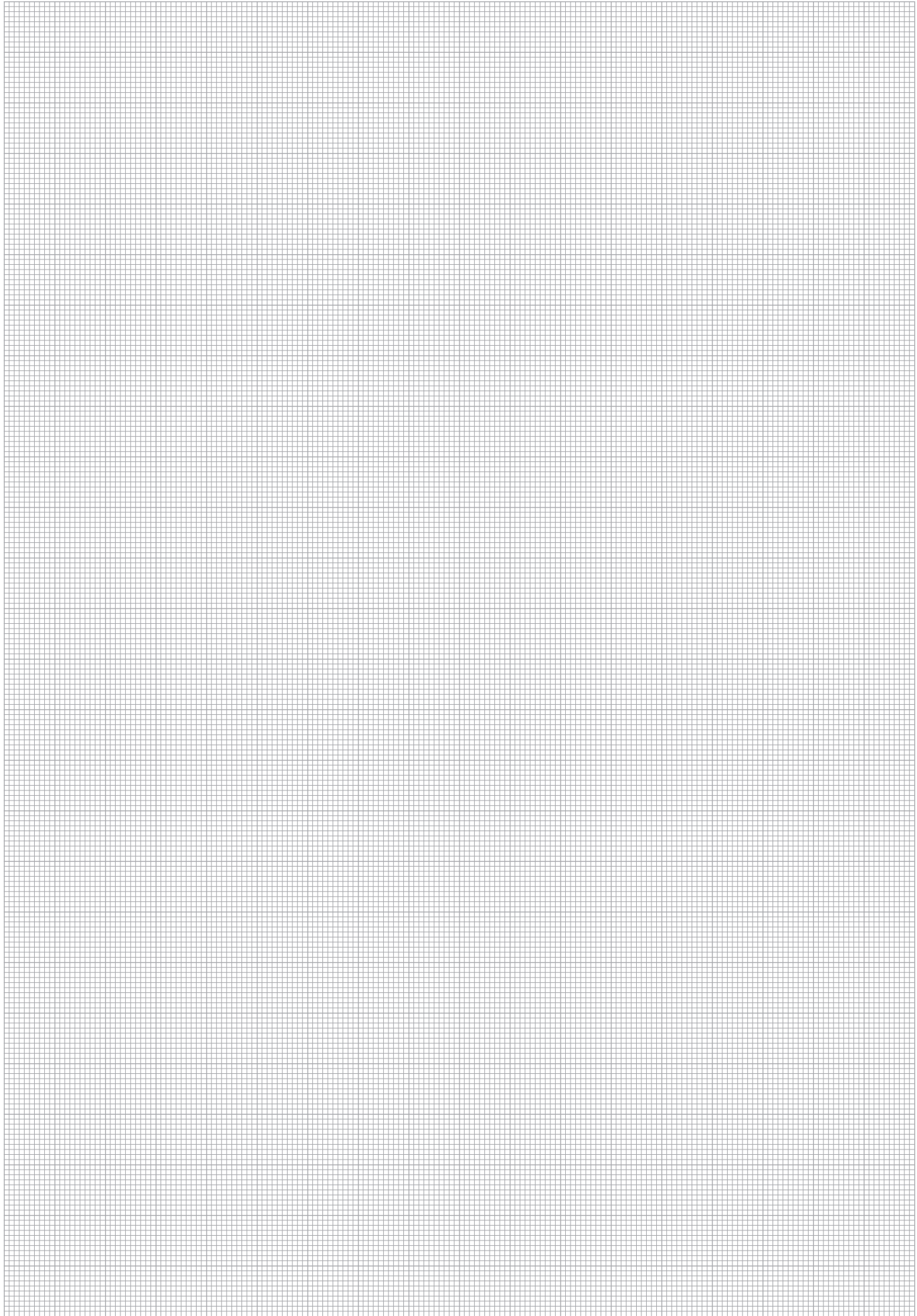

HS



Series HS • Stainless Steel

Series HS • Overview	126
Series HS-06 • BG 1 • Nominal Size 6,3	127
Series HS-10 • BG 2 • Nominal Size 10	127
Series HS-12 • BG 3 • Nominal Size 12,5	127
Series HS-19 • BG 4 • Nominal Size 19	127
Series HS-25 • BG 6 • Nominal Size 25	128
Series HS-38 • BG 8 • Nominal Size 38	128

Series HS • Dust Protection	129
-----------------------------	-----



HS



### Series HS ▪ Stainless Steel

Material	Stainless Steel V4A (AISI 316)
Surface Finishing	-
Standard Seal Material(s)	FKM (Viton®) <sup>2</sup>
Working Temperature	-25° C ... +200° C / -13° F ... +392° F
Valve Design	Poppet Valve
Connection	Screw
Disconnection	Screw
Connect Under Pressure	Male Tip/Female Body up to 33% of the Working Pressure with Tools
Application	Agricultural and Forestry Machinery, Construction Machinery, Industrial Hydraulic
ISO Interchange	ISO 14541 (BG 1-6)



<sup>2</sup>Alternative seal materials are available on request.

### Technical Data

Series	BG	DN Zoll Inch	DN metric ISO 4397	Q <sub>max</sub>		Working Pressure		Bursting Pressure Connected		Female Body		Male Tip		Spillage	
				l/min	US GPM	bar	PSI	bar	PSI	bar	PSI	bar	PSI	ml	fl oz
HS-06	1	1/4"	6,3	17	4.49	300	4351	1200	17405	1200	17405	1200	17405	0,8	.0271
HS-10	2	3/8"	10	30	7.93	250	3626	1500	21756	1400	20305	1000	14504	1,9	.0642
HS-12	3	1/2"	12,5	80	21.13	250	3626	1800	26107	1800	26107	1100	15954	2,7	.0913
HS-19	4	3/4"	19 (20)	106	28.00	150	2176	1700	24656	700	10153	600	8702	9,3	.3145
HS-25	6	1"	25	189	49.93	150	2176	1200	17405	600	8702	600	8702	16	.5410
HS-38	8	1 1/2"	38	350	92.46	100	1450	400	5802	400	5802	400	5802	30	10.144

The indicated pressure ratings only apply to the coupling itself and depend on the connection type.

### Flow Characteristics

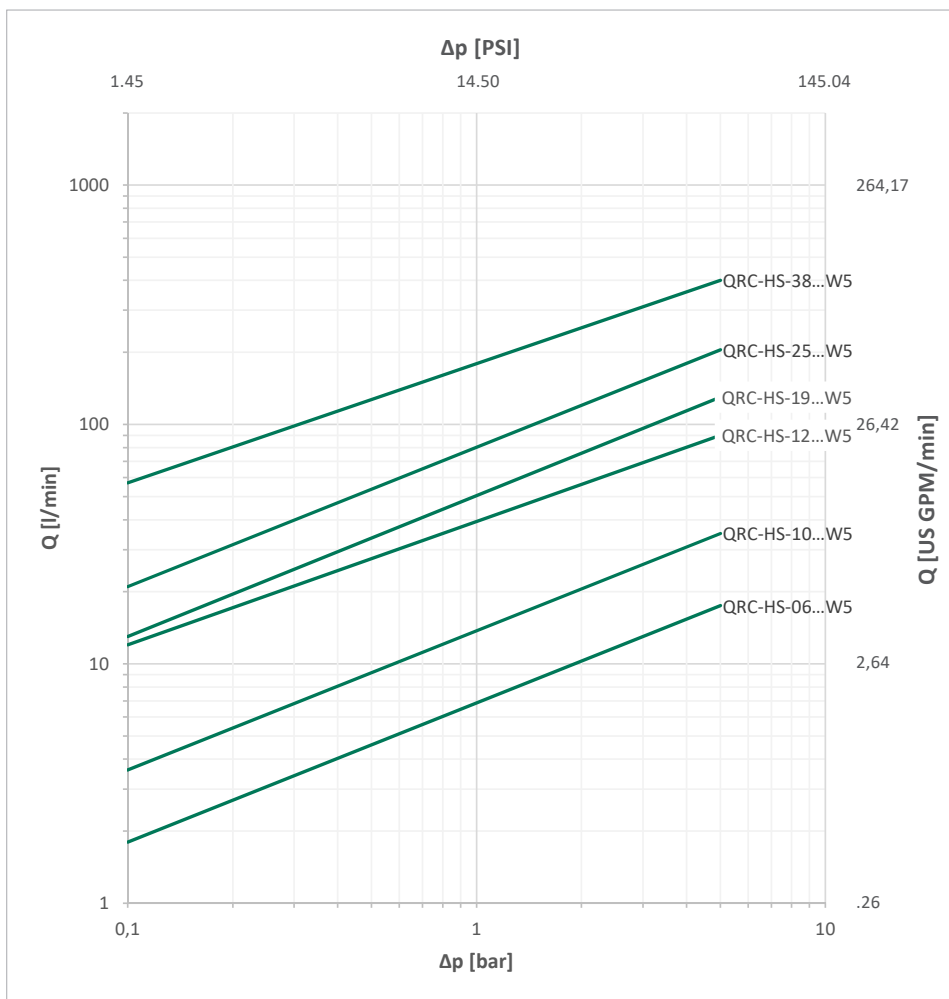

Please note: Unless otherwise stated, all flow characteristics have been determined with hydraulic oil with a kinematic viscosity of 28,8 - 35,2 mm<sup>2</sup>/s (28,8 - 35,2 cSt) and are only valid for components with non-reducing connections.



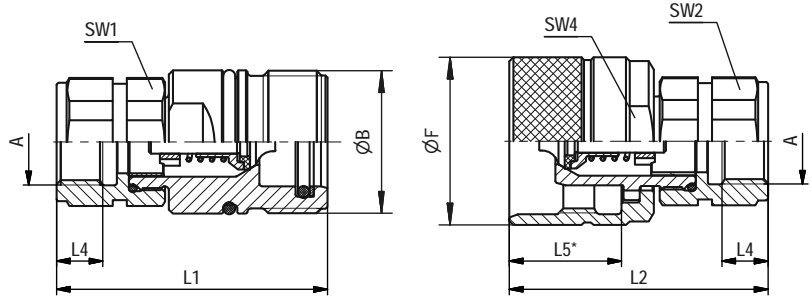

SW: Width across flats. All dimensions in mm (inch). Drawing similar Series HS-12.  
\* Insertion Female Body.

### Series HS-06 ▪ BG 1 ▪ Nominal Size 6,3

Port A	Dimensions (mm/in)	Female Body									Weight ( <sup>kg</sup> /lbs) ca. per 100	Male Tip Ordering Codes	Weight ( <sup>kg</sup> /lbs) ca. per 100	
		ØB	ØF	L1	L2	L4 min	L5	SW1	SW2	SW4				Ordering Codes
Female Thread according to DIN 3852 - ISO 1179-1														
	G 1/4"	M24x2	30	59,1	58	12	25,1	19	19	27	QRC-HS-06-F-G04-VT-W5	12,20 26.90	QRC-HS-06-M-G04-V-W5	13 28.66
			1.18	2.33	2.28	.47	.99	.75	.75	1.06				

### Series HS-10 ▪ BG 2 ▪ Nominal Size 10

Port A	Dimensions (mm/in)	Female Body									Weight ( <sup>kg</sup> /lbs) ca. per 100	Male Tip Ordering Codes	Weight ( <sup>kg</sup> /lbs) ca. per 100	
		ØB	ØF	L1	L2	L4 min	L5	SW1	SW2	SW4				Ordering Codes
Female Thread according to DIN 3852 - ISO 1179-1														
	G 3/8"	M28x2	34	64,5	62	12	26,5	22	22	30	QRC-HS-10-F-G06-VT-W5	16,30 35.94	QRC-HS-10-M-G06-V-W5	17,40 38.36
			1.34	2.54	2.44	.47	1.04	.87	.87	1.18				

### Series HS-12 ▪ BG 3 ▪ Nominal Size 12,5

Port A	Dimensions (mm/in)	Female Body									Weight ( <sup>kg</sup> /lbs) ca. per 100	Male Tip Ordering Codes	Weight ( <sup>kg</sup> /lbs) ca. per 100	
		ØB	ØF	L1	L2	L4 min	L5	SW1	SW2	SW4				Ordering Codes
Female Thread according to DIN 3852 - ISO 1179-1														
	G 3/8"	M36x2	41,8	67	63	12	28	30	30	38	QRC-HS-12-F-G06-VT-W5	33,10 72.97	QRC-HS-12-M-G06-V-W5	30,50 67.24
			1.64	2.64	2.48	.47	1.1	1.18	1.18	1.49				
	G 1/2"	M36x2	41,8	67	63	12	28	30	30	38	QRC-HS-12-F-G08-VT-W5	31,20 68.78	QRC-HS-12-M-G08-V-W5	28,10 61.95
			1.64	2.64	2.48	.47	1.1	1.18	1.18	1.49				

### Series HS-19 ▪ BG 4 ▪ Nominal Size 19

Port A	Dimensions (mm/in)	Female Body									Weight ( <sup>kg</sup> /lbs) ca. per 100	Male Tip Ordering Codes	Weight ( <sup>kg</sup> /lbs) ca. per 100	
		ØB	ØF	L1	L2	L4 min	L5	SW1	SW2	SW4				Ordering Codes
Female Thread according to DIN 3852 - ISO 1179-1														
	G 3/4"	M42x2	48	82	75	16	21	36	36	41	QRC-HS-19-F-G12-VT-W5	51,10 112.66	QRC-HS-19-M-G12-V-W5	44,10 97.22
			1.89	3.23	2.95	.63	.83	1.42	1.42	1.61				

Note: The connection of the two halves of a coupling is achieved depending on the type. It is important to observe the positive engagement of plug-type couplings and the secure tightening of screw-type couplings to the limit stop of the thread. Forced or improper separation will result in malfunction of the coupling.



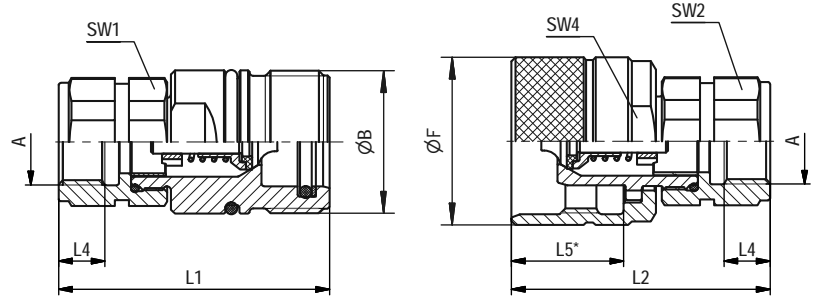

SW: Width across flats. All dimensions in mm (inch). Drawing similar Series HS-12.  
\* Insertion Female Body.

**Series HS-25 • BG 6 • Nominal Size 25**

Port A	Dimensions (mm/inch)										Female Body Ordering Codes	Weight ( <sup>kg</sup> / <sub>lbs</sub> ) ca. per 100	Male Tip Ordering Codes	Weight ( <sup>kg</sup> / <sub>lbs</sub> ) ca. per 100
	ØB	ØF	L1	L2	L4 min	L5	SW1	SW2	SW4					
Female Thread according to DIN 3852 - ISO 1179-1														
 G 3/4"	M48x3	55	95	78,5	16		35,5	41	16	50	QRC-HS-25-F-G12-VT-W5	74,80	QRC-HS-25-M-G12-V-W5	65,10
		2.16	3.74	3.09	.63		1.40	1.61	.63	1.97		164.91		143.52
 G 1"	M48x3	55	95	78,5	18		35,5	41	18	50	QRC-HS-25-F-G16-VT-W5	71,30	QRC-HS-25-M-G16-V-W5	61,50
		2.16	3.74	3.09	.71		1.40	1.61	.71	1.97		157.19		135.58

**Series HS-38 • BG 8 • Nominal Size 38**

Port A	Dimensions (mm/inch)										Female Body Ordering Codes	Weight ( <sup>kg</sup> / <sub>lbs</sub> ) ca. per 100	Male Tip Ordering Codes	Weight ( <sup>kg</sup> / <sub>lbs</sub> ) ca. per 100
	ØB	ØF	L1	L2	L4 min	L5	SW1	SW2	SW4					
Female Thread according to DIN 3852 - ISO 1179-1														
 G 1 1/4"	M70x3	80	116	121	20		44	60	20	65	QRC-HS-38-F-G20-VT-W5	180,20	QRC-HS-38-M-G20-V-W5	235
		3.12	4.57	4.76	.79		1.73	2.36	.79	2.56		397.27		518.09
 G 1 1/2"	M70x3	80	116	121	22		44	60	22	65	QRC-HS-38-F-G24-VT-W5	173	QRC-HS-38-M-G24-V-W5	227,80
		3.12	4.57	4.76	.87		1.73	2.36	.87	2.56		381.40		502,21

HS

Note: The connection of the two halves of a coupling is achieved depending on the type. It is important to observe the positive engagement of plug-type couplings and the secure tightening of screw-type couplings to the limit stop of the thread. Forced or improper separation will result in malfunction of the coupling.



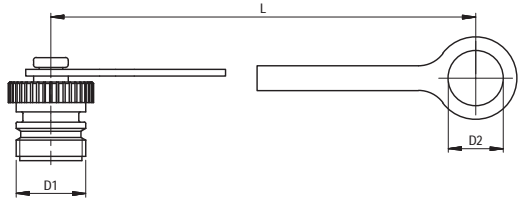
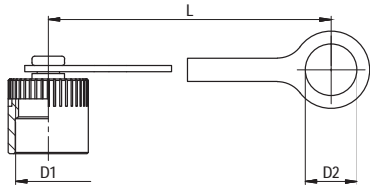

**Series HS • Dust Protection**

Dimensions (mm/in)			Material	Dust Cap for Female Body
D1	D2	L		Ordering Codes
M24x2	19 .75	180 7.09	Plastic (Colour: Red)	<b>QRC-HS-06-DF-19-K-RD</b>
M28x2	23 .91	180 7.09	Plastic (Colour: Red)	<b>QRC-HS-10-DF-23-K-RD</b>
M36x2	29,5 1.16	185 7.28	Plastic (Colour: Red)	<b>QRC-HS-12-DF-30-K-RD</b>
M42x2	36,5 1.44	190 7.48	Plastic (Colour: Red)	<b>QRC-HS-19-DF-37-K-RD</b>
M48x3	41 1.61	190 7.48	Plastic (Colour: Red)	<b>QRC-HS-25-DF-41-K-RD</b>
M70x3	55 2.17	201 7.91	Plastic (Colour: Red)	<b>QRC-HS-38-DF-55-K-RD</b>

Dimensions (mm/in)			Material	Dust Plug for Male Tip
D1	D2	L		Ordering Codes
M24x2	19 .75	180 7.09	Plastic (Colour: Red)	<b>QRC-HS-06-DM-19-K-RD</b>
M28x2	23 .91	180 7.09	Plastic (Colour: Red)	<b>QRC-HS-10-DM-23-K-RD</b>
M36x2	29,5 1.16	185 7.28	Plastic (Colour: Red)	<b>QRC-HS-12-DM-30-K-RD</b>
M42x2	36,5 1.44	190 7.48	Plastic (Colour: Red)	<b>QRC-HS-19-DM-37-K-RD</b>
M48x3	41 1.61	190 7.48	Plastic (Colour: Red)	<b>QRC-HS-25-DM-41-K-RD</b>
M70x3	55 2.17	201 7.91	Plastic (Colour: Red)	<b>QRC-HS-38-DM-55-K-RD</b>

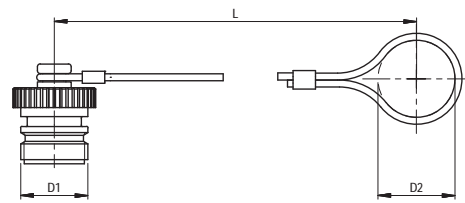
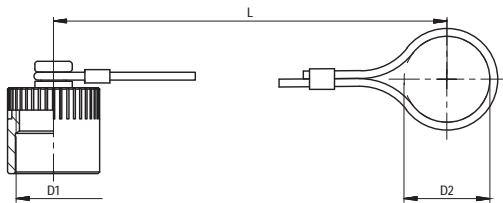

Dimensions (mm/in)			Material	Dust Cap for Female Body
D1	D2	L		Ordering Codes
M24x2			Aluminium with steel cable	<b>QRC-HS-06-DF-19-W89-SI</b>
M28x2			Aluminium with steel cable	<b>QRC-HS-10-DF-23-W89-SI</b>
M36x2			Aluminium with steel cable	<b>QRC-HS-12-DF-30-W89-SI</b>
M42x2			Aluminium with steel cable	<b>QRC-HS-19-DF-37-W89-SI</b>
M48x3			Aluminium with steel cable	<b>QRC-HS-25-DF-41-W89-SI</b>
M70x3			Aluminium with steel cable	<b>QRC-HS-38-DF-55-W89-SI</b>

Dimensions (mm/in)			Material	Dust Plug for Male Tip
D1	D2	L		Ordering Codes
M24x2			Aluminium with steel cable	<b>QRC-HS-06-DM-19-W89-SI</b>
M28x2			Aluminium with steel cable	<b>QRC-HS-10-DM-23-W89-SI</b>
M36x2			Aluminium with steel cable	<b>QRC-HS-12-DM-30-W89-SI</b>
M42x2			Aluminium with steel cable	<b>QRC-HS-19-DM-37-W89-SI</b>
M48x3			Aluminium with steel cable	<b>QRC-HS-25-DM-41-W89-SI</b>
M70x3			Aluminium with steel cable	<b>QRC-HS-38-DM-55-W89-SI</b>

In addition to the standard colours as stated above, plastic dust caps are also available in blue, green, yellow and black. Please use the color codes BU, GN, YE and BK respectively instead of RD.

**HS**



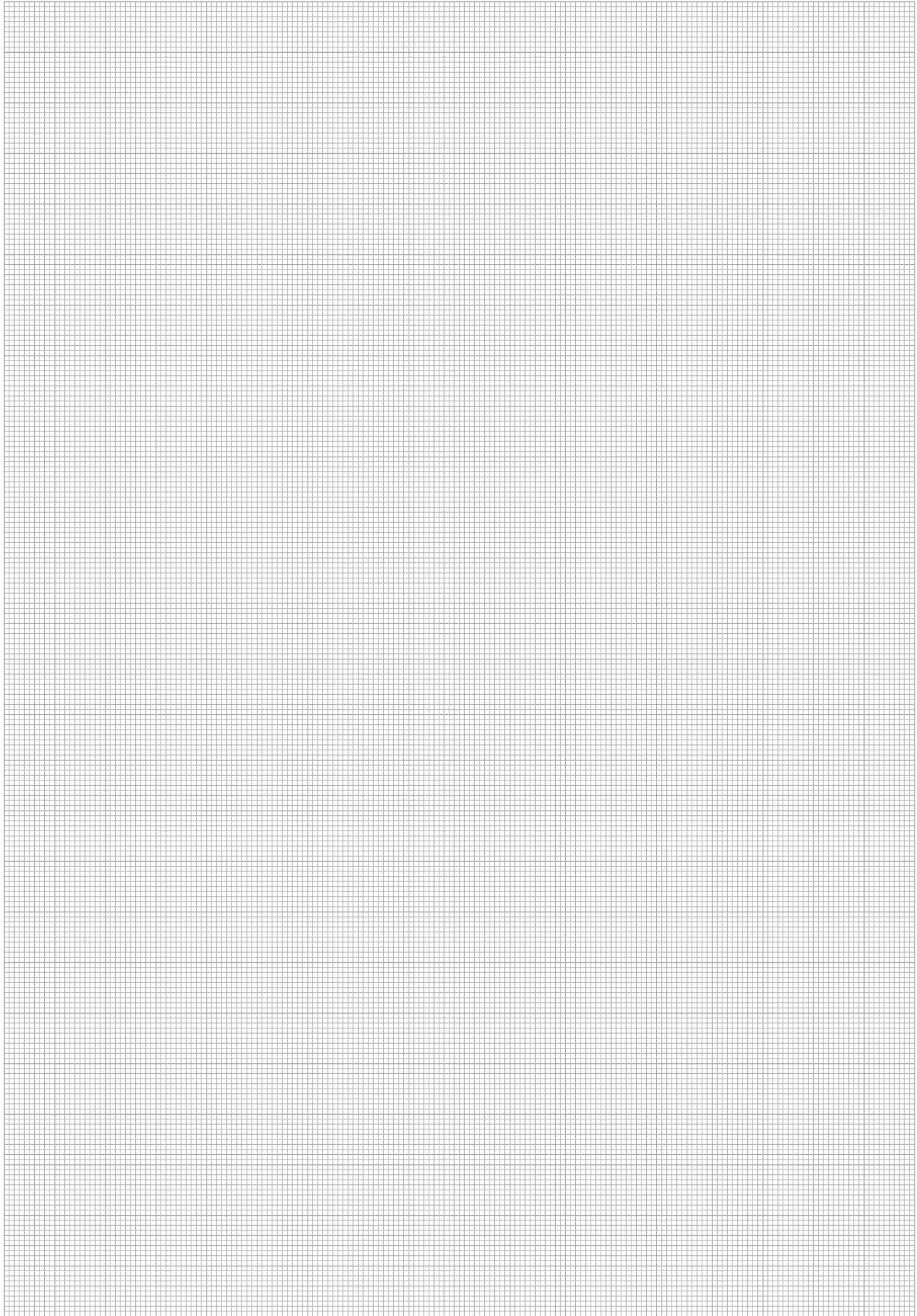

HS



**Series PS • Carbon Steel**

<b>Series PS • Overview</b>	<b>132</b>
<b>Series PS-25 • BG 08 • Nominal Size 25</b>	<b>133</b>
<b>Series PS • Dust Protection</b>	<b>133</b>

**PS**

### Series PS ▪ Carbon Steel

Material	Carbon Steel
Surface Finishing	Zinc-Nickel
Standard Seal Material(s)	HNBR, FKM (Viton®), PTFE <sup>2</sup>
Working Temperature	-20° C ... +150° C / -4° F ... +302° F
Valve Design	Poppet Valve
Connection	Screw
Disconnection	Screw
Connect Under Pressure	not allowed
Application	Construction Machinery
ISO Interchange	-



<sup>2</sup>Alternative seal materials are available on request.

### Technical Data

Series	BG	DN Zoll	DN metric ISO 4397	Q <sub>max</sub>		Working Pressure		Bursting Pressure Connected		Female Body		Male Tip		Spillage	
				l/min	US GPM	bar	PSI	bar	PSI	bar	PSI	bar	PSI	ml	fl oz
PS-25	08	1 1/4"	25	600 (1000)*	158.50	380	5511	1520	22046	1520	22046	1520	22046	27	.9130

The indicated pressure ratings only apply to the coupling itself and depend on the connection type.

\* short term possible

### Flow Characteristics

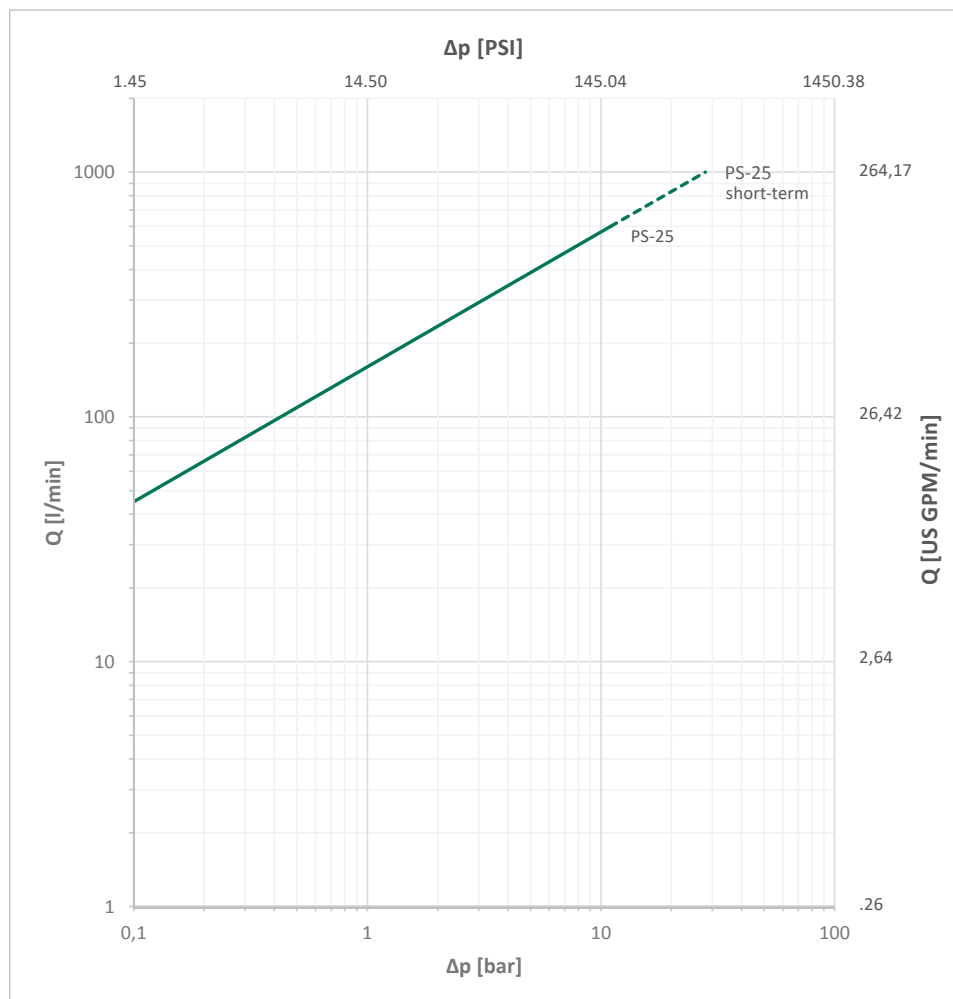

Please note: Unless otherwise stated, all flow characteristics have been determined with hydraulic oil with a kinematic viscosity of 28,8 - 35,2 mm<sup>2</sup>/s (28,8 - 35,2 cSt) and are only valid for components with non-reducing connections.

PS



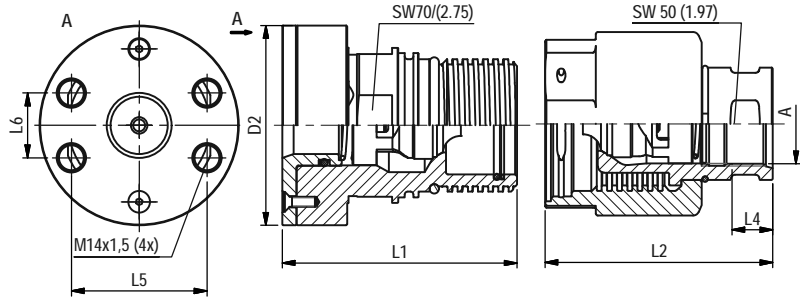

SW: Width across flats. All dimensions in mm (inch).

**Series PS-25 • BG 08 • Nominal Size 25**

Port A	Dimensions (mm/in)							Female Body Ordering Codes	Weight (kg/lbs) ca. per 100	Male Tip Ordering Codes	Weight (kg/lbs) ca. per 100
	ØD2	L1	L2	L3	L4	L5	L6				
<b>Flange SAE 6000 PSI</b>											
	1" 1/4	98	115,5 4.55	115,5 4.55		66,7 2,62	31,8 1,24	QRC-PS-25-F-C620M-S3-W3	300,40 662,27		
<b>Female Thread according to SAE J1926-14 - ISO 11926-1</b>											
	UN 1" 5/8 -12		112 4.41	19 .75						QRC-PS-25-M-U20-HB-W3	262,60 578,93
	<b>Female Thread according to DIN 3852-2-A</b>										
	G 1" 1/4	76 2.99	122 4.80	112 4.41	21,5 .85			QRC-PS-25-F-G20-S3-W3	244 537.93	QRC-PS-25-M-G20-HB-W3	255,90 564.16

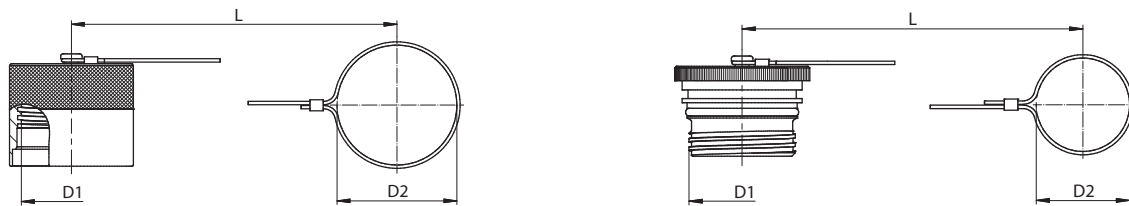
**PS**
**Series PS • Dust Protection**

Dimensions (mm/in)			Material	Dust Cap for Female Body
D1	D2	L		Ordering Codes
So. 65x5	80 3.15	280 11.02	Aluminium silver with steel cable	QRC-PS-25-DF-80-W89-SI

Dimensions (mm/in)			Material	Dust Plug for Male Tip
D1	D2	L		Ordering Codes
So. 65x5	56 2.20	240 9.45	Aluminium silver with steel cable	QRC-PS-25-DM-56-W89-SI

Note: The connection of the two halves of a coupling is achieved depending on the type. It is important to observe the positive engagement of plug-type couplings and the secure tightening of screw-type couplings to the limit stop of the thread. Forced or improper separation will result in malfunction of the coupling.



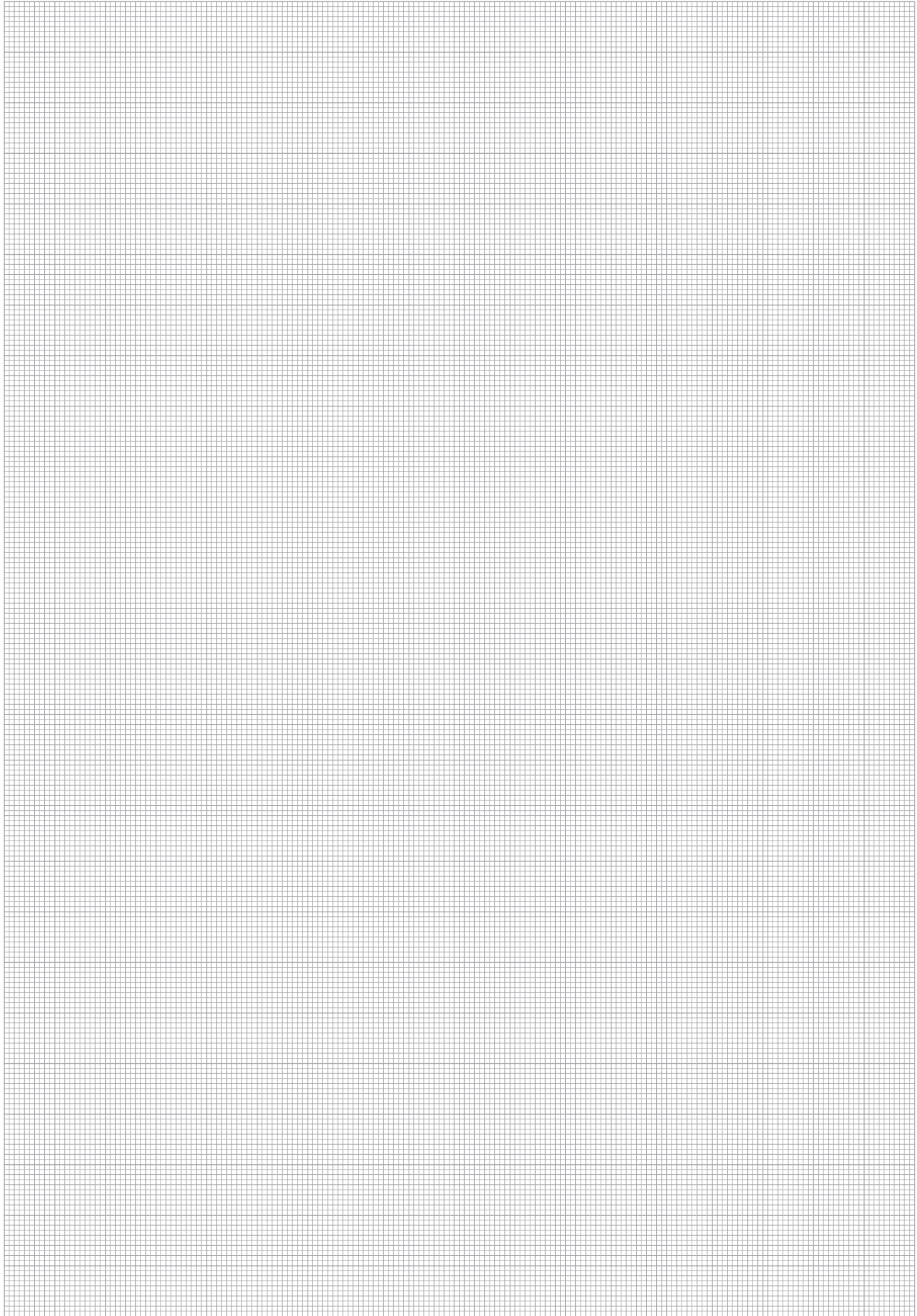

PS



Series RH - Carbon Steel

Series RH - Overview	136
Series RH-10 - BG 2 - Nominal Size 10	137
Series RH-12 - BG 3 - Nominal Size 12,5	137
Series RH-16 - BG 4 - Nominal Size 16	138
Series RH-19 - BG 6 - Nominal Size 19	138
Series RH-25 - BG 8 - Nominal Size 25	139
Series RH - Dust Protection	139



RH



**Series RH - Carbon Steel**

Material	Carbon Steel
Surface Finishing	Zinc-Nickel
Standard Seal Material(s)	NBR (Buna-N®), PTFE <sup>2</sup>
Working Temperature	-30° C ... +100° C / -22° F ... +212° F
Valve Design	Flat Valve
Connection	Screw
Disconnection	Screw
Connect Under Pressure	Max. 20 bar / 290 PSI Residual Pressure with Tools allowed
Application	Construction Machinery
ISO Interchange	-



<sup>2</sup>Alternative seal materials are available on request.

**Technical Data**

Series	BG	DN Zoll Inch	DN metric ISO 4397	Q <sub>max</sub>		Working Pressure*		Bursting Pressure Connected		Female Body		Male Tip		Spillage	
				l/min	US GPM	bar	PSI	bar	PSI	bar	PSI	bar	PSI	ml	fl oz
RH-10	2	3/8"	10	40	10.57	420	6092	1300	18855	1350	19580	1450	210301	0,1	.0034
RH-12	3	1/2"	12,5	70	18.49	420	6092	1260	18275	1260	18275	1260	18275	0,16	.0054
RH-16	4	5/8"	16	105	27.74	420	6092	1260	18275	1260	18275	1260	18275	1,02	.0344
RH-19	6	3/4"	19	200	52.83	420	6092	1300	18855	1400	20305	1200	17405	0,86	.0291
RH-25	8	1"	25	500	132.09	420	6092	1150	16679	1100	15954	900	13053	2,84	.0960

The indicated pressure ratings only apply to the coupling itself and depend on the connection type.  
\* in connected and disconnected condition.

**Flow Characteristics**

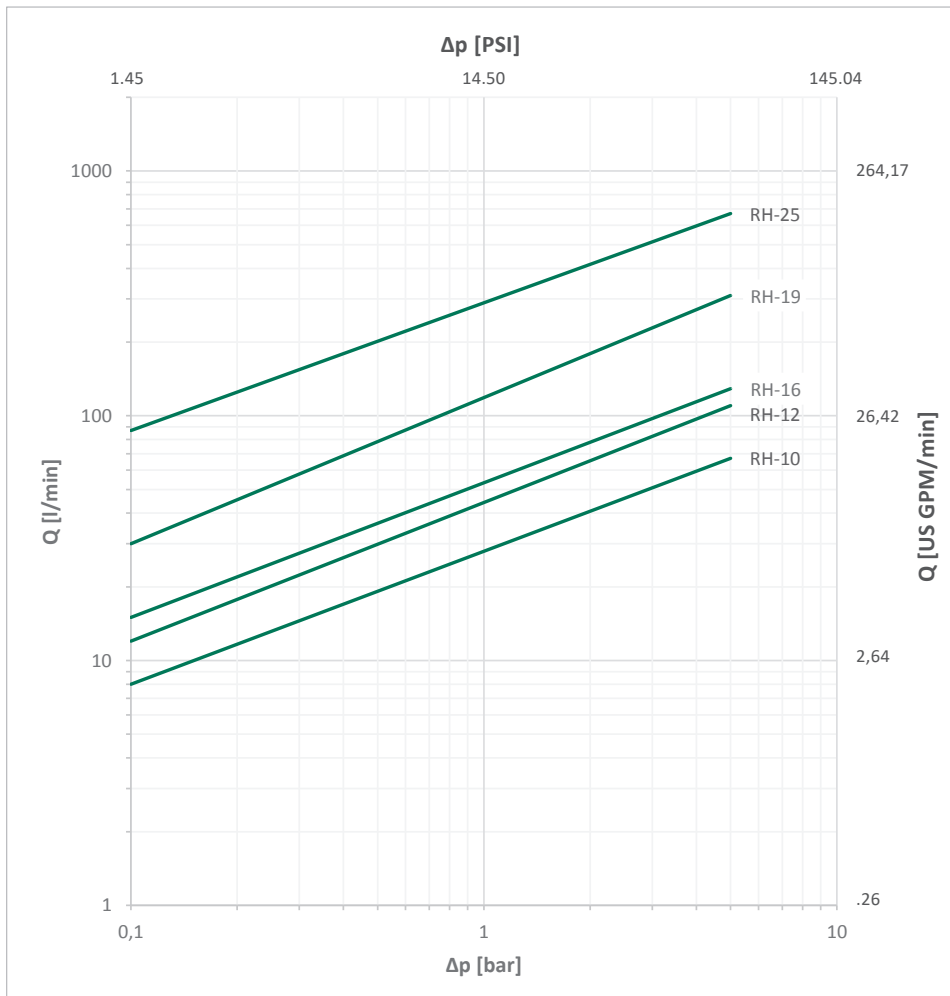

Please note: Unless otherwise stated, all flow characteristics have been determined with hydraulic oil with a kinematic viscosity of 28,8 - 35,2 mm<sup>2</sup>/s (28,8 - 35,2 cSt) and are only valid for components with non-reducing connections.

RH





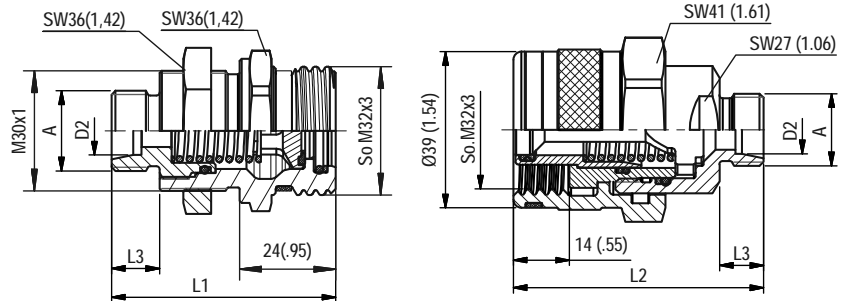

SW: Width across flats. All dimensions in mm (inch).

**Series RH-10 • BG 2 • Nominal Size 10**

Port A	Dimensions ( <sup>mm</sup> / <sub>in</sub> )					Female Body Ordering Codes	Weight ( <sup>kg</sup> / <sub>lbs</sub> ) ca. per 100	Male Tip Ordering Codes	Weight ( <sup>kg</sup> / <sub>lbs</sub> ) ca. per 100
	ØD2	L1	L2	L3	L4				
<b>Male Thread with 24° Conical Bore - Shape W according to DIN 3861</b>									
	M14x1.5	8L	54 2.13	61 2.40	10 .39	QRC-RH-10-F-08L-S1-W3	20,80 45.86	QRC-RH-10-M-08L-BT-W3	31,80 70.11
	M16x1.5	10L	55 2.17	61 2.40	11 .43	QRC-RH-10-F-10L-S1-W3	21 46.30	QRC-RH-10-M-10L-BT-W3	32 70.55
	M18x1.5	12L	55 2.17	61 2.40	11 .43	QRC-RH-10-F-12L-S1-W3	21,20 46.74	QRC-RH-10-M-12L-BT-W3	32,20 70.99
	M22x1.5	15L	56 2.20	62 2.44	12 .47	QRC-RH-10-F-15L-S1-W3	22 48.50	QRC-RH-10-M-15L-BT-W3	32,90 72.53
	M18x1.5	10S	56 2.20	62 2.44	12 .47	QRC-RH-10-F-10S-S1-W3	21,50 47.40	QRC-RH-10-M-10S-BT-W3	32,60 71.87
	M20x1.5	12S	56 2.20	62 2.44	12 .47	QRC-RH-10-F-12S-S1-W3	22 48.50	QRC-RH-10-M-12S-BT-W3	33 72.75
	M22x1.5	14S	58 2.28	64 2.52	14 .55	QRC-RH-10-F-14S-S1-W3	22,70 50.04	QRC-RH-10-M-14S-BT-W3	33,80 74.52
	M24x1.5	16S	58 2.28	64 2.52	14 .55	QRC-RH-10-F-16S-S1-W3	23 50.71	QRC-RH-10-M-16S-BT-W3	33,90 74.74

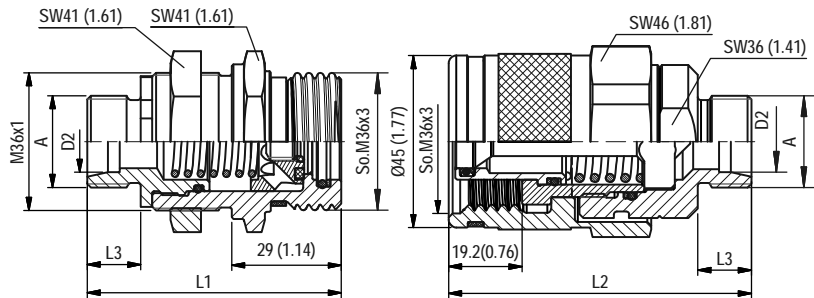

SW: Width across flats. All dimensions in mm (inch).

**Series RH-12 • BG 3 • Nominal Size 12,5**

Port A	Dimensions ( <sup>mm</sup> / <sub>in</sub> )					Female Body Ordering Codes	Weight ( <sup>kg</sup> / <sub>lbs</sub> ) ca. per 100	Male Tip Ordering Codes	Weight ( <sup>kg</sup> / <sub>lbs</sub> ) ca. per 100
	ØD2	L1	L2	L3	L4				
<b>Male Thread with 24° Conical Bore - Shape W according to DIN 3861</b>									
	M22x1.5	15L	65 2.56	78 3.07	12 .47	QRC-RH-12-F-15L-S1-W3	31,20 68.78	QRC-RH-12-M-15L-BT-W3	56,40 124.34
	M24x1.5	16S	67 2.64	80 3.15	14 .55	QRC-RH-12-F-16S-S1-W3	32 70.55	QRC-RH-12-M-16S-BT-W3	57,30 126.32
	M30x2	20S	69,5 2.74	81,2 3.20	16 .63	QRC-RH-12-F-20S-S1-W3	34,80 76.72	QRC-RH-12-M-20S-BT-W3	59,50 131.18

Note: The connection of the two halves of a coupling is achieved depending on the type. It is important to observe the positive engagement of plug-type couplings and the secure tightening of screw-type couplings to the limit stop of the thread. Forced or improper separation will result in malfunction of the coupling.



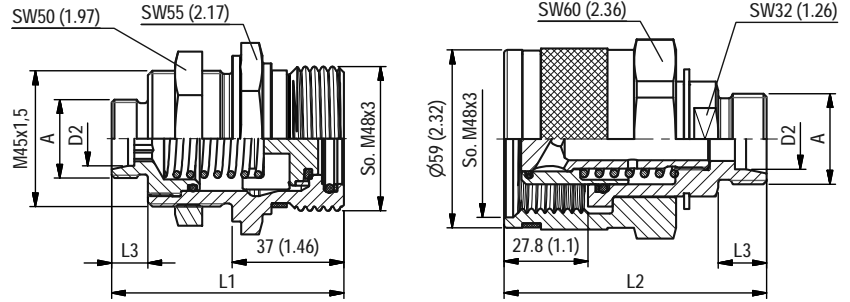

SW: Width across flats. All dimensions in mm (inch).

**Series RH-16 • BG 4 • Nominal Size 16**

Port A	Dimensions (mm/in)					Female Body Ordering Codes	Weight (kg/lbs) ca. per 100	Male Tip Ordering Codes	Weight (kg/lbs) ca. per 100
	ØD2	L1	L2	L3	L4				
<b>Male Thread with 24° Conical Bore - Shape W according to DIN 3861</b>									
	M22x1,5	15L	77 3.03	77 3.03	12 .47	QRC-RH-16-F-15L-S1-W3	61,40 135.36	QRC-RH-16-M-15L-BT-W3	94 207.23
	M26x1,5	18L	77 3.03	77 3.03	12 .47	QRC-RH-16-F-18L-S1-W3	61,60 135.80	QRC-RH-16-M-18L-BT-W3	94,30 207.90
			79 3.11	79 3.11	14 .55	QRC-RH-16-F-16S-S1-W3	61,70 136.03	QRC-RH-16-M-16S-BT-W3	94,50 208.34
	M30x2	20S	81 3.19	81 3.19	16 .63	QRC-RH-16-F-20S-S1-W3	62 136.69	QRC-RH-16-M-20S-BT-W3	94,90 209.22

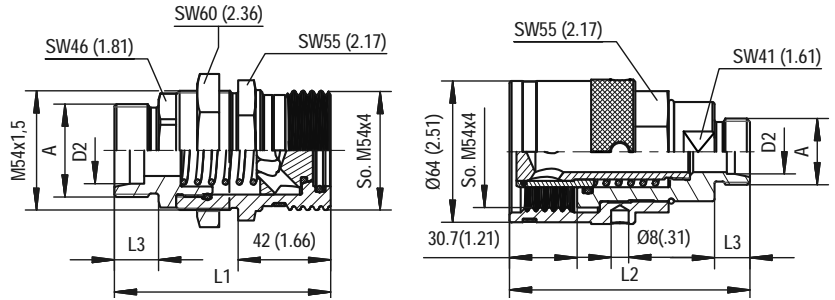

SW: Width across flats. All dimensions in mm (inch).

**Series RH-19 • BG 6 • Nominal Size 19**

Port A	Dimensions (mm/in)					Female Body Ordering Codes	Weight (kg/lbs) ca. per 100	Male Tip Ordering Codes	Weight (kg/lbs) ca. per 100
	ØD2	L1	L2	L3	L4				
<b>Male Thread with 24° Conical Bore - Shape W according to DIN 3861</b>									
	M26x1,5	18L	90 3.54	103 4.06	12 .47	QRC-RH-19-F-18L-S1-W3	88 194.01	QRC-RH-19-M-18L-BT-W3	128,80 283.96
			M30x2	22L	92 3.62	105 4.13	14 .55	QRC-RH-19-F-22L-S1-W3	88,80 195.77
	M36x2	28L			92 3.62	107 4.21	14 .55	QRC-RH-19-F-28L-S1-W3	90 198.42
			M30x2	20S	95 3.74	109 4.29	16 .63	QRC-RH-19-F-20S-S1-W3	92,20 203.27
	M36x2	25S			97 3.82	111 4.37	18 .71	QRC-RH-19-F-25S-S1-W3	93 205.03
			M42x2	30S	99 3.90	113 4.45	20 .79	QRC-RH-19-F-30S-S1-W3	95,80 211.20

Note: The connection of the two halves of a coupling is achieved depending on the type. It is important to observe the positive engagement of plug-type couplings and the secure tightening of screw-type couplings to the limit stop of the thread. Forced or improper separation will result in malfunction of the coupling.



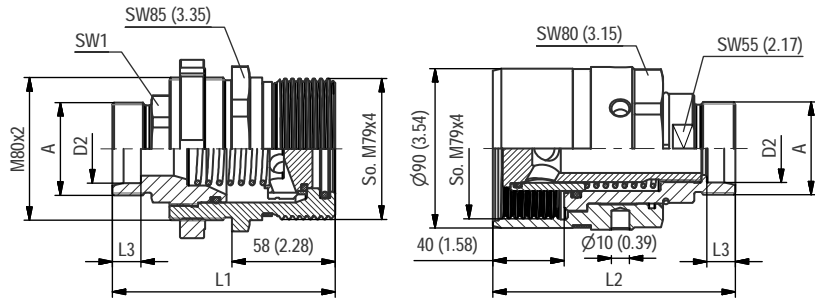

SW: Width across flats. All dimensions in mm (inch).

**Series RH-25 ▪ BG 8 ▪ Nominal Size 25**

Port A	Dimensions (mm/in)						Female Body Ordering Codes	Weight (kg/lbs) ca. per 100	Male Tip Ordering Codes	Weight (kg/lbs) ca. per 100
	ØD2	L1	L2	L3	L4	SW1				
<b>Male Thread with 24° Conical Bore - Shape W according to DIN 3861</b>										
	M45x2	35L	122 4.80	136 5.35	16 .63	46 1.81	<b>QRC-RH-25-F-35L-S1-W3</b>	273 601.86	<b>QRC-RH-25-M-35L-BT-W3</b>	335 738.55
	M52x2	42L	122 4.80	136 5.35	16 .63	55 2.17	<b>QRC-RH-25-F-42L-S1-W3</b>	283 623.91	<b>QRC-RH-25-M-42L-BT-W3</b>	335 738.55
	M52x2	38S	125 4.92	136 5.35	22 .87	55 2.17	<b>QRC-RH-25-F-38S-S1-W3</b>	285.50 629.42	<b>QRC-RH-25-M-38S-BT-W3</b>	334.50 737.45

**Series RH ▪ Dust Protection**

Dimensions (mm/in)			Material	Dust Cap for Female Body
D1	D2	L		Ordering Codes
M32x3	36,5 1.44	190 7.48	Plastic (Colour: Red)	<b>QRC-RH-10-DF-37-K-RD</b>
M32x3	29,5 1.16	185 7.28		<b>QRC-RH-10-DF-30-K-RD</b>
M36x3	41 1.61	190 7.48	Plastic (Colour: Red)	<b>QRC-RH-12-DF-41-K-RD</b>
M48x3	55 2.17	210 8.27		<b>QRC-RH-16-DF-55-K-RD</b>

Dimensions (mm/in)			Material	Dust Plug for Male Tip
D1	D2	L		Ordering Codes
M32x3	29,5 1.16	185 7.28	Plastic (Colour: Red)	<b>QRC-RH-10-DM-30-K-RD</b>
M36x3	29,5 1.16	185 7.28		<b>QRC-RH-12-DM-30-K-RD</b>
M48x3	36,5 1.44	190 7.48	Plastic (Colour: Red)	<b>QRC-RH-16-DM-37-K-RD</b>

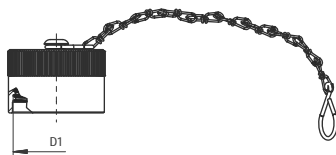

Dimensions (mm/in)			Material	Dust Cap for Female Body
D1	D2	L		Ordering Codes
So. M48x3			Aluminium silver with chain	<b>QRC-RH-16-DF-CN-W89-SI</b>
So. M54x4				<b>QRC-RH-19-DF-CN-W89-SI</b>
So. M79x4				<b>QRC-RH-25-DF-CN-W89-SI</b>

Dimensions (mm/in)			Material	Dust Plug for Male Tip
D1	D2	L		Ordering Codes
So. M48x3			Aluminium silver with chain	<b>QRC-RH-16-DM-CN-W89-SI</b>
So. M54x4				<b>QRC-RH-19-DM-CN-W89-SI</b>
So. M79x4				<b>QRC-RH-25-DM-CN-W89-SI</b>

In addition to the standard colours as stated above, plastic dust caps are also available in blue, green, yellow and black. Please use the color codes BU, GN, YE and BK respectively instead of RD.

Note: The connection of the two halves of a coupling is achieved depending on the type. It is important to observe the positive engagement of plug-type couplings and the secure tightening of screw-type couplings to the limit stop of the thread. Forced or improper separation will result in malfunction of the coupling.



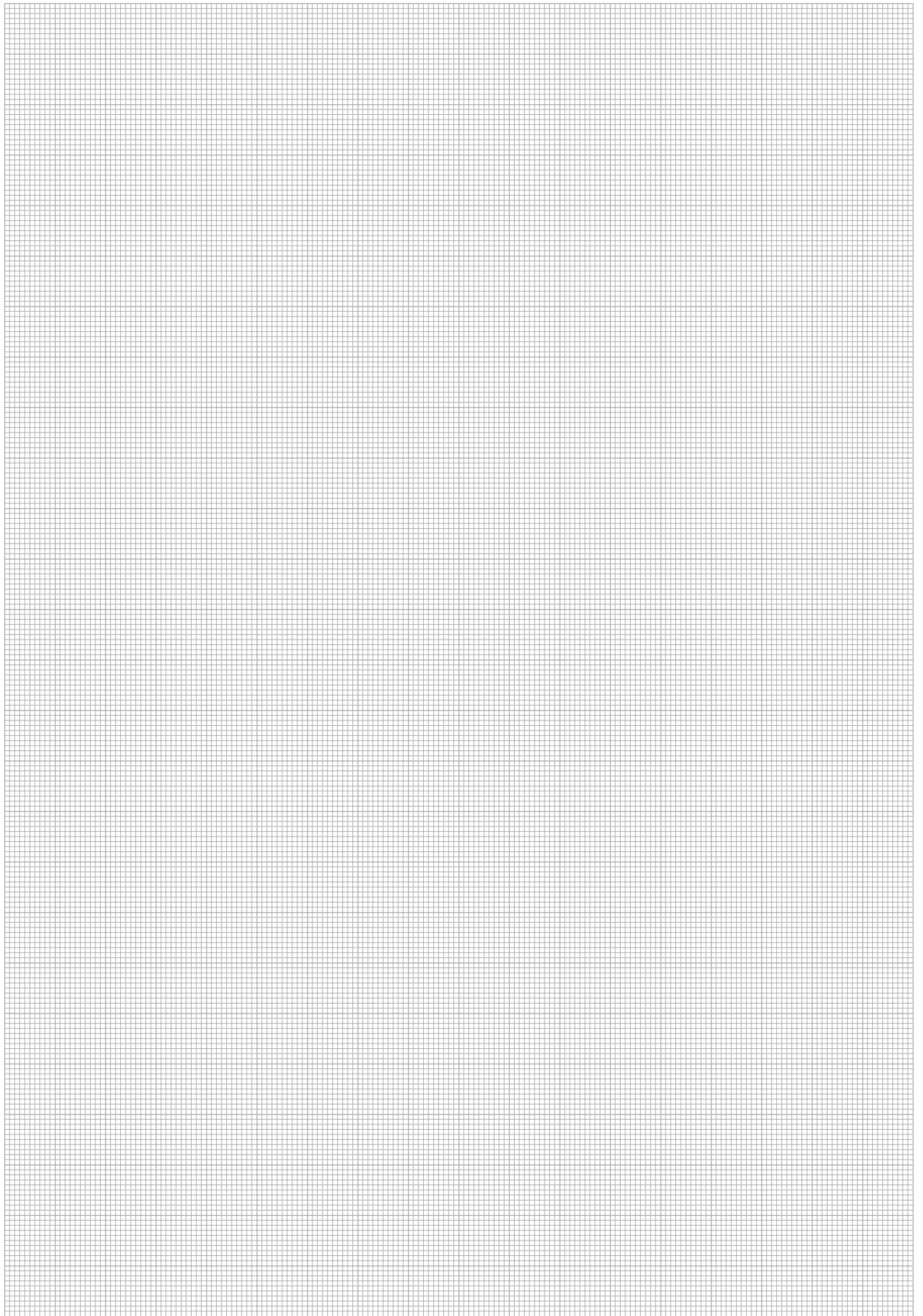

RH



Series FT • Carbon Steel

Series FT • Overview	142
Series FT-10 • BG 2 • Nominal Size 10	143
Series FT-12 • BG 3 • Nominal Size 12,5	143
Series FT-16 • BG 4A • Nominal Size 16	144
Series FT-19 • BG 4 • Nominal Size 19	144
Series FT-25 • BG 5 • Nominal Size 25	145
Series FT-31 • BG 6 • Nominal Size 31,5	145

Series FT • Dust Protection	146
-----------------------------	-----



FT



### Series FT • Carbon Steel

Material	Carbon Steel
Surface Finishing	Zinc-Nickel
Standard Seal Material(s)	NBR (Buna-N®), PTFE <sup>2</sup>
Working Temperature	-25° C ... +100° C / -13° F ... +212° F
Valve Design	Flat Face
Connection	Screw
Disconnection	Screw
Connect Under Pressure	Male Tip up to the max. Working Pressure allowed
Application	Construction Machinery, Industrial Hydraulic
ISO Interchange	-



<sup>2</sup>Alternative seal materials are available on request.

### Technical Data

Series	BG	DN Zoll Inch	DN metric ISO 4397	Q <sub>max</sub>		Working Pressure		Bursting Pressure Connected		Female Body		Male Tip		Spillage	
				l/min	US GPM	bar	PSI	bar	PSI	bar	PSI	bar	PSI	ml	fl oz
FT-10	2	3/8"	10	80	21.13	550	7977	1400	20305	1100	15954	1400	20305	0,04	.0014
FT-12	3	1/2"	12,5	120	31.70	550	7977	1400	20305	1000	14504	1400	20305	0,025	.0008
FT-16	4A	5/8"	16	140	36.98	550	7977	1400	20305	1000	14504	1600	23206		
FT-19	4	3/4"	19	180	47.55	500	7252	1400	20305	1050	15229	1400	20305	0,018	.0006
FT-25	5	1"	25	260	68.68	470	6817	1300	18855	1000	14504	1300	18855	0,06	.0020
FT-31	6	1 1/4"	31,5	600	158.50	400	5802	1100	15954	1100	15954	1100	15954		

The indicated pressure ratings only apply to the coupling itself and depend on the connection type.

### Flow Characteristics

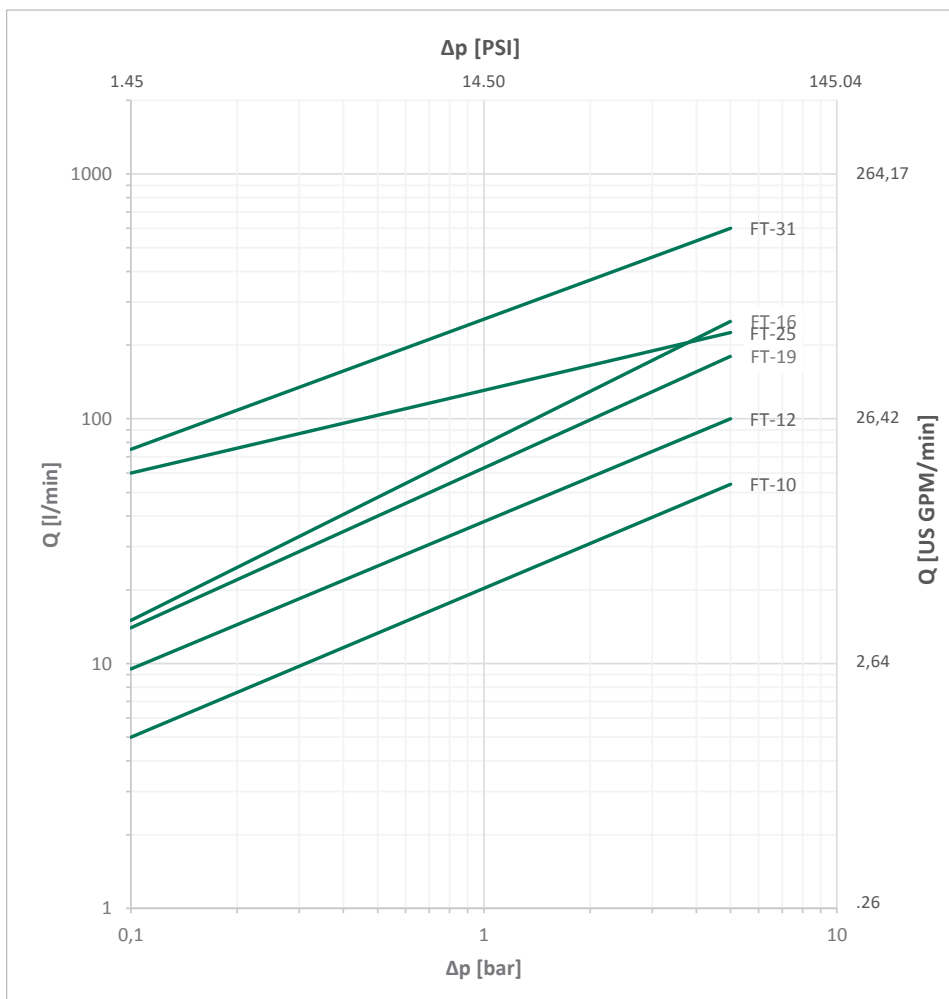

Please note: Unless otherwise stated, all flow characteristics have been determined with hydraulic oil with a kinematic viscosity of 28,8 - 35,2 mm<sup>2</sup>/s (28,8 - 35,2 cSt) and are only valid for components with non-reducing connections.



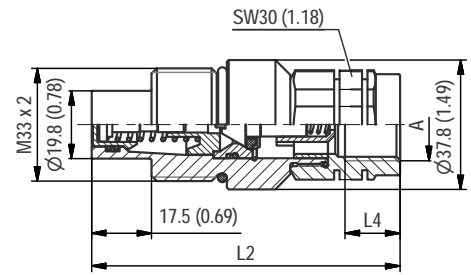
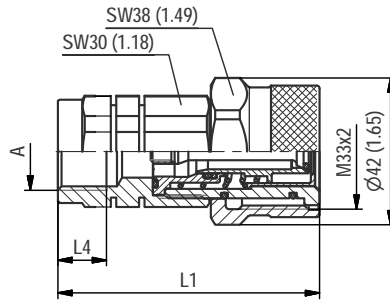

SW: Width across flats. All dimensions in mm (inch).

**Series FT-10 • BG 2 • Nominal Size 10**

Port A	Dimensions (mm/in)				Female Body Ordering Codes	Weight ( <sup>kg</sup> /lbs) ca. per 100	Male Tip Ordering Codes	Weight ( <sup>kg</sup> /lbs) ca. per 100
	ØD2	L1	L2	L3				
Female Thread according to DIN 3852-2 - ANSI B 1.20.3 - SAE J1926-1 - ISO 11926-1								
	G 3/8"	70 2.76	87 3.43		12 .47	QRC-FT-10-F-G06-BT-W3 36 79.37	QRC-FT-10-M-G06-BT-W3 38,40 84.66	
	G 1/2"	75 2.95	90 3.54		14 .55	QRC-FT-10-F-G08-BT-W3 36,50 80.47	QRC-FT-10-M-G08-BT-W3 37,90 83.56	
	NPTF 3/8" -18	75 2.95	90 3.54			QRC-FT-10-F-NF06-BT-W3 38,30 84.44	QRC-FT-10-M-NF06-BT-W3 39,70 87.52	
	NPTF 1/2" -14	75 2.95	90 3.54			QRC-FT-10-F-NF08-BT-W3 36,90 81.35	QRC-FT-10-M-NF08-BT-W3 38,50 84.89	
	UNF 3/4" -16	75 2.95	87 3.43		14,3 .56	QRC-FT-10-F-U08-BT-W3 37,30 82.23	QRC-FT-10-M-U08-BT-W3 37,50 82.67	

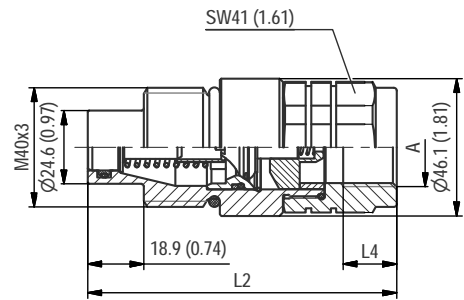
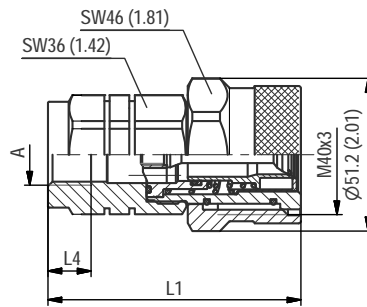

SW: Width across flats. All dimensions in mm (inch).

**Series FT-12 • BG 3 • Nominal Size 12,5**

Port A	Dimensions (mm/in)				Female Body Ordering Codes	Weight ( <sup>kg</sup> /lbs) ca. per 100	Male Tip Ordering Codes	Weight ( <sup>kg</sup> /lbs) ca. per 100
	ØD2	L1	L2	L3				
Female Thread according to DIN 3852-2 - ANSI B 1.20.3 - SAE J1926-1 - ISO 11926-1								
	G 1/2"	85 3.35	98 3.86		14,5 .57	QRC-FT-12-F-G08-BT-W3 65,70 144.84	QRC-FT-12-M-G08-BT-W3 67,10 147.93	
		G 3/4"	85 3.35	104 4.09		16 .63	QRC-FT-12-F-G12-BT-W3 62,50 137.79	QRC-FT-12-M-G12-BT-W3 69,10 152.34
	NPTF 1/2" -14	85 3.35	104 4.09			QRC-FT-12-F-NF08-BT-W3 61,70 136.03	QRC-FT-12-M-NF08-BT-W3 73,10 161.16	
		NPTF 3/4" -14	85 3.35	104 4.09			QRC-FT-12-F-NF12-BT-W3 63 138.89	QRC-FT-12-M-NF12-BT-W3 67,50 148.81
	UNF 3/4" -16	85 3.35	98 3.86		16 .63	QRC-FT-12-F-U08-BT-W3 65,80 145.06	QRC-FT-12-M-U08-BT-W3 69,60 153.44	
		UN 1" 1/16 -12	85 3.35	104 4.09		19 .75	QRC-FT-12-F-U12-BT-W3 61 134.48	QRC-FT-12-M-U12-BT-W3 68,50 151.02

**FT**

Note: The connection of the two halves of a coupling is achieved depending on the type. It is important to observe the positive engagement of plug-type couplings and the secure tightening of screw-type couplings to the limit stop of the thread. Forced or improper separation will result in malfunction of the coupling.



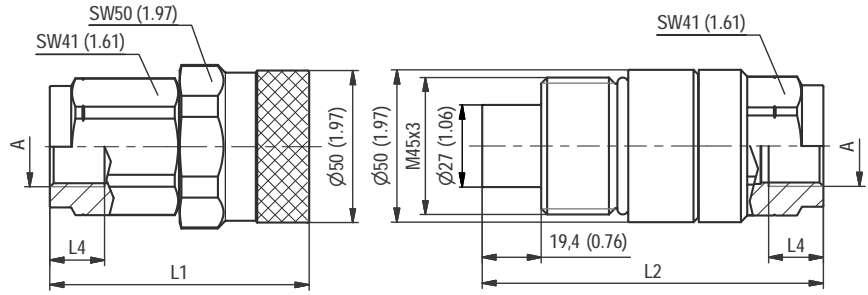

SW: Width across flats. All dimensions in mm (inch).

**Series FT-16 • BG 4A • Nominal Size 16**

Port A	Dimensions (mm/in)				Female Body Ordering Codes	Weight (kg/lbs) ca. per 100	Male Tip Ordering Codes	Weight (kg/lbs) ca. per 100
	ØD2	L1	L2	L3 L4				
Female Thread according to 3852-2 - ANSI B 1.20.3 - SAE J1926-1 - ISO 11926-1								
	G 3/4"	85	112	16	QRC-FT-16-F-G12-BT-W3	80,30 177.03	QRC-FT-16-M-G12-S2-W3	96,30 212.31
	G 1"	87	114	18	QRC-FT-16-F-G16-BT-W3	76,80 169.31	QRC-FT-16-M-G16-S2-W3	92,80 204.59
	NPTF 3/4" -14	85	112		QRC-FT-16-F-NF12-BT-W3	79,80 175.93	QRC-FT-16-M-NF12-S2-W3	96,90 213.63
	UN 1" 1/16 -12	85	112	19	QRC-FT-16-F-U12-BT-W3	74,50 164.24	QRC-FT-16-M-U12-S2-W3	95,60 210.76

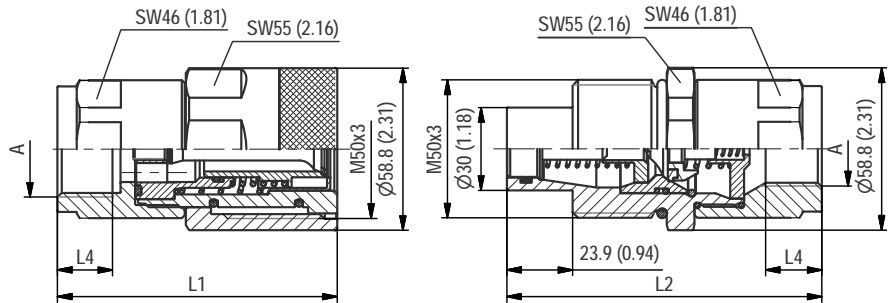

SW: Width across flats. All dimensions in mm (inch).

**Series FT-19 • BG 4 • Nominal Size 19**

Port A	Dimensions (mm/in)				Female Body Ordering Codes	Weight (kg/lbs) ca. per 100	Male Tip Ordering Codes	Weight (kg/lbs) ca. per 100
	ØD2	L1	L2	L3 L4				
Female Thread according to DIN 3852-2 - ANSI B 1.20.3 - SAE J1926-1 - ISO 11926-1								
	G 3/4"	101	114	16	QRC-FT-19-F-G12-BT-W3	135,50 298.73	QRC-FT-19-M-G12-BT-W3	106,10 233.91
	G 1"	101	114	18	QRC-FT-19-F-G16-BT-W3	129,80 286.16	QRC-FT-19-M-G16-BT-W3	101,40 223.55
	NPTF 1" -11 1/2	101	114		QRC-FT-19-F-NF16-BT-W3	132 291.01	QRC-FT-19-M-NF16-BT-W3	102,80 226.64
	UN 1" 5/16 -12	101	114	19	QRC-FT-19-F-U16-BT-W3	129,70 285.94	QRC-FT-19-M-U16-BT-W3	100,50 221.56

Note: The connection of the two halves of a coupling is achieved depending on the type. It is important to observe the positive engagement of plug-type couplings and the secure tightening of screw-type couplings to the limit stop of the thread. Forced or improper separation will result in malfunction of the coupling.





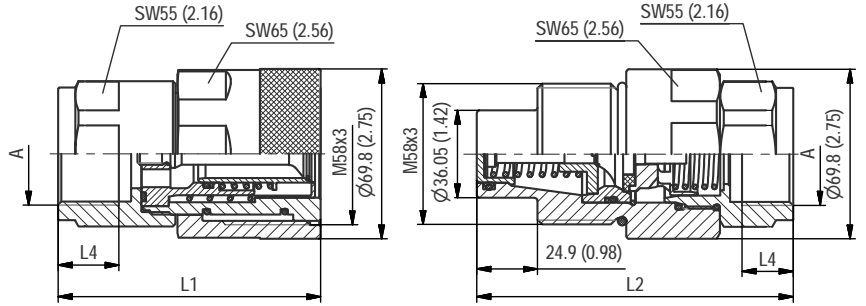

SW: Width across flats. All dimensions in mm (inch).

**Series FT-25 • BG 5 • Nominal Size 25**

Port A	Dimensions (mm/in)				Female Body Ordering Codes	Weight ( <sup>kg</sup> /lbs) ca. per 100	Male Tip Ordering Codes	Weight ( <sup>kg</sup> /lbs) ca. per 100	
	ØD2	L1	L2	L3					L4
Female Thread according to DIN 3852-2 - ANSI B 1.20.3 - SAE J1926-1 - ISO 11926-1									
	G 1" 1/4	108	130		20	QRC-FT-25-F-G20-BT-W3	150,20	QRC-FT-25-M-G20-BT-W3	189,70
		4.25	5.12		.79		331.13		418.22
	NPTF 1"¼ -11½	108	130			QRC-FT-25-F-NF20-BT-W3	153,90	QRC-FT-25-M-NF20-BT-W3	191,90
		4.25	5.12				339.29		423.07
	UN 1" 5/8 - 12	108	130		19	QRC-FT-25-F-U20-BT-W3	152,30	QRC-FT-25-M-U20-BT-W3	190,40
		4.25	5.12		.75		335.76		419.76

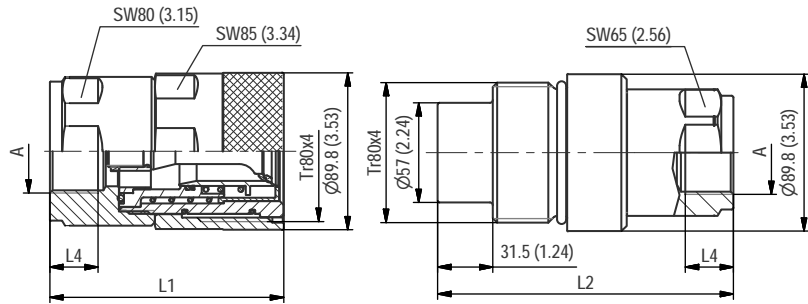

SW: Width across flats. All dimensions in mm (inch).

**Series FT-31 • BG 6 • Nominal Size 31,5**

Port A	Dimensions (mm/in)				Female Body Ordering Codes	Weight ( <sup>kg</sup> /lbs) ca. per 100	Male Tip Ordering Codes	Weight ( <sup>kg</sup> /lbs) ca. per 100	
	ØD2	L1	L2	L3					L4
Female Thread according to DIN 3852-2 - ANSI B 1.20.3 - SAE J1926-1 - ISO 11926-1									
	G 1" 1/2	134	169		22	QRC-FT-31-F-G24-S1-W3	442,20	QRC-FT-31-M-G24-S2-W3	402
		5.28	6.65		.87		974.88		886.26
	NPTF 1"½ -11	134	169			QRC-FT-31-F-NF24-S1-W3	444,20	QRC-FT-31-M-NF24-S2-W3	404,10
		5.28	6.65				979.29		890.89
	UN 1" 7/8 - 12	134	169		19	QRC-FT-31-F-U24-S1-W3	439,20	QRC-FT-31-M-U24-S2-W3	400,50
		5.28	6.65		.75		968.27		882.95

**FT**

Note: The connection of the two halves of a coupling is achieved depending on the type. It is important to observe the positive engagement of plug-type couplings and the secure tightening of screw-type couplings to the limit stop of the thread. Forced or improper separation will result in malfunction of the coupling.



Series FT • Dust Protection

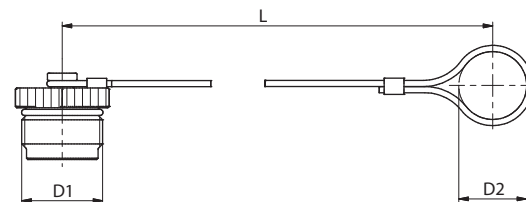
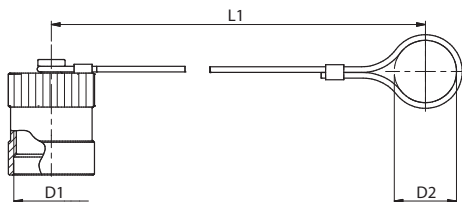

Dimensions ( <sup>mm</sup> / <sub>in</sub> )			Material	Dust Cap for Male Tip
D1	D2	L		Ordering Codes
M33x2	30 1.18	175 6.89	Aluminium silver with steel cable	QRC-FT-10-DM-30-W89-SI
M40x3	40,5 1.59	215 8.46		QRC-FT-12-DM-41-W89-SI
M45x3	42,5 1.67	230 9.06	Aluminium silver with steel cable	QRC-FT-16-DM-43-W89-SI
M50x3	46 1.81	245 9.65		QRC-FT-19-DM-46-W89-SI
M58x3	55 2.17	275 10.83	Aluminium silver with steel cable	QRC-FT-25-DM-55-W89-SI
TR80x4	71,5 2.81	350 13.78		QRC-FT-31-DM-72-W89-SI

Dimensions ( <sup>mm</sup> / <sub>in</sub> )			Material	Dust Plug for Female Body
D1	D2	L		Ordering Codes
M33x2	30 1.18	175 6.89	Aluminium silver with steel cable	QRC-FT-10-DF-30-W89-SI
M40x3	36 1.42	215 8.46		QRC-FT-12-DF-36-W89-SI
M45x3	42,5 1.67	230 9.06	Aluminium silver with steel cable	QRC-FT-16-DF-43-W89-SI
M50x3	46 1.81	245 9.65		QRC-FT-19-DF-46-W89-SI
M58x3	55 2.17	275 10.83	Aluminium silver with steel cable	QRC-FT-25-DF-55-W89-SI
TR80x4	71,5 2.81	350 13.78		QRC-FT-31-DF-72-W89-SI

FT



Series HR - Carbon Steel

Series HR - Overview	148	Series HR - Dust Protection	151
Series HR-10 - BG 2 - Nominal Size 10	149		
Series HR-12 - BG 3 - Nominal Size 12,5	149		
Series HR-19 - BG 4 - Nominal Size 19	149		
Series HR-25 - BG 6 - Nominal Size 25	149		
Series HR-31 - BG 8 - Nominal Size 31,5	150		
Series HR-38 - BG 10 - Nominal Size 38	150		



HR



### Series HR ▪ Carbon Steel

Material	Carbon Steel
Surface Finishing	Zinc-Plating and Thick-Film-Passivation (Chrome III)
Standard Seal Material(s)	NBR (Buna-N®) <sup>2</sup>
Working Temperature	-25° C ... +100° C / -13° F ... +212° F
Valve Design	Poppet Valve
Connection	Screw
Disconnection	Screw
Connect Under Pressure	Male Tip and Female Body up to max. 100 bar / 1450 PSI allowed
Application	Construction Machinery
ISO Interchange	-



<sup>2</sup>Alternative seal materials are available on request.

### Technical Data

Series	BG	DN Zoll	DN metric ISO 4397	Q <sub>max</sub>		Working Pressure		Bursting Pressure Connected		Female Body		Male Tip		Spillage	
				l/min	US GPM	bar	PSI	bar	PSI	bar	PSI	bar	PSI	ml	fl oz
HR-10	2	3/8"	10	50	13.21	610	8847	2450	35534	2450	35534	2600	37710	2	.0676
HR-12	3	1/2"	12,5	85	22.45	470	6817	1900	27557	2100	30458	1650	23931	3	.1014
HR-19	4	3/4"	19 (20)	120	31.70	310	4496	1250	18130	1500	21756	1250	18130	10	.3381
HR-25	6	1"	25	280	73.97	300	4351	1300	18855	1600	23206	1100	15954	16	.5410
HR-31	8	1 1/4"	31	460	121.52	300	4351	1300	18855	1300	18855	1200	17405	30	10.144
HR-38	10	1 1/2"	38	700	184.92	270	3916	1100	15954	1500	21756	950	13779	54	18.260

The indicated pressure ratings only apply to the coupling itself and depend on the connection type.

### Flow Characteristics

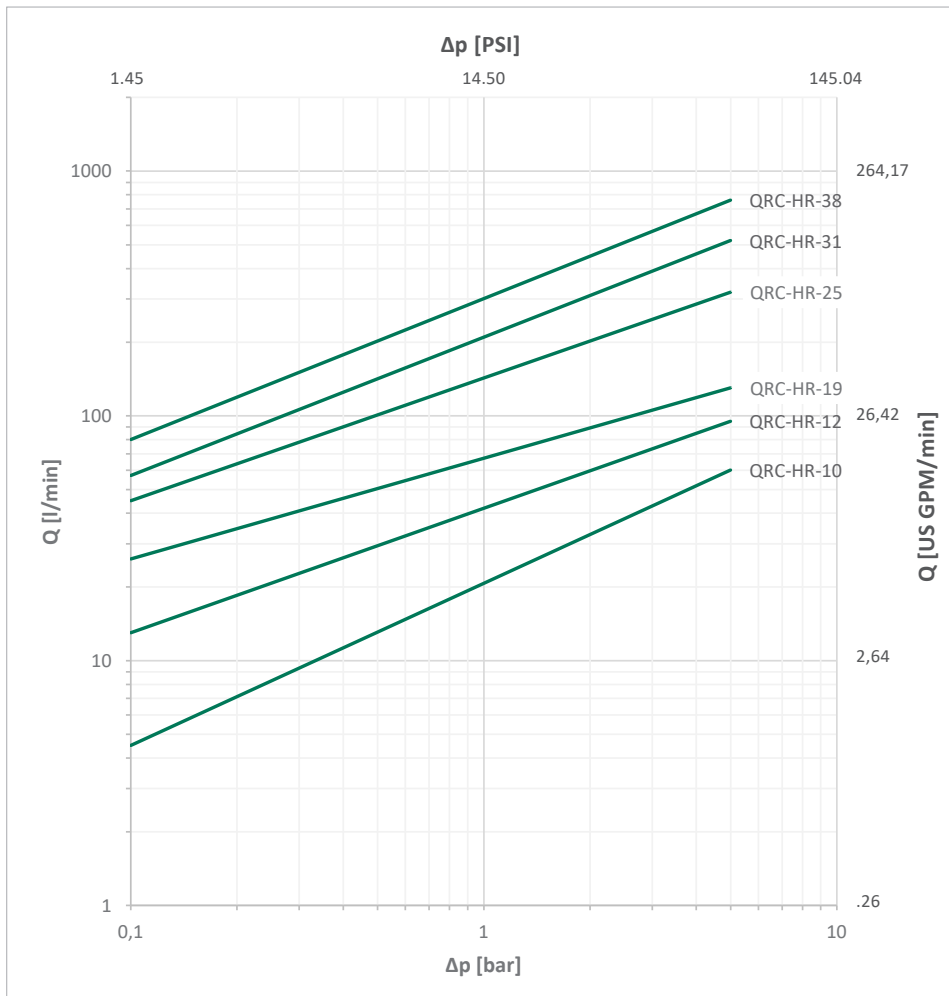

Please note: Unless otherwise stated, all flow characteristics have been determined with hydraulic oil with a kinematic viscosity of 28,8 - 35,2 mm<sup>2</sup>/s (28,8 - 35,2 cSt) and are only valid for components with non-reducing connections.



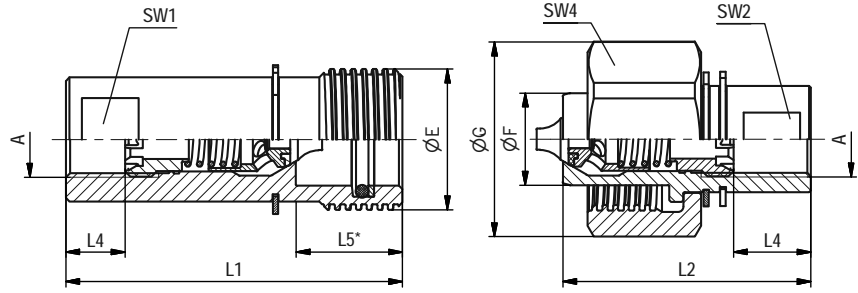

SW: Width across flats. All dimensions in mm (inch). Drawing similar Series HR-12.  
\* Insertion Female Body.

### Series HR-10 • BG 2 • Nominal Size 10

Port A	Dimensions ( <sup>mm</sup> / <sub>in</sub> )											Female Body Ordering Codes	Weight ( <sup>kg</sup> / <sub>lbs</sub> ) ca. per 100	Male Tip Ordering Codes	Weight ( <sup>kg</sup> / <sub>lbs</sub> ) ca. per 100	
	ØE	ØF	ØG	L1	L2	L4 min	L5	SW1	SW2	SW4						
Female Thread according to DIN 3852 - ISO 1179-1																
 G 3/8"	36	22	49	77	57	12	22	22	22	45	QRC-HR-10-F-G06-BT-W66	31,80	QRC-HR-10-M-G06-B-W66	35,20		
	1.42	.87	1.93	3.03	2.24	.47	.87	.87	.87	1.77		70.11		77.60		
	36	22	49	77	57	12	22	22	22	45		QRC-HR-10-FD-G06-BT-W66-DM		37,10	QRC-HR-10-MD-G06-B-W66-DM	41
	1.42	.87	1.93	3.03	2.24	.47	.87	.87	.87	1.77		81.79		QRC-HR-10-MD-G06-B-W66-DM	90.39	

### Series HR-12 • BG 3 • Nominal Size 12,5

Port A	Dimensions ( <sup>mm</sup> / <sub>in</sub> )											Female Body Ordering Codes	Weight ( <sup>kg</sup> / <sub>lbs</sub> ) ca. per 100	Male Tip Ordering Codes	Weight ( <sup>kg</sup> / <sub>lbs</sub> ) ca. per 100	
	ØE	ØF	ØG	L1	L2	L4 min	L5	SW1	SW2	SW4						
Female Thread according to DIN 3852 - ISO 1179-1																
 G 1/2"	40	26	55	95	70	14	30	26	26	50	QRC-HR-12-F-G08-BT-W66	48,40	QRC-HR-12-M-G08-B-W66	48		
	1.57	1.02	2.16	3.74	2.76	.55	1.18	1.02	1.02	1.97		106.70		105.82		
	40	26	55	95	70	14	30	26	26	50		QRC-HR-12-FD-G08-BT-W66-DM		54	QRC-HR-12-MD-G08-B-W66-DM	56,60
	1.57	1.02	2.16	3.74	2.76	.55	1.18	1.02	1.02	1.97		119.05		QRC-HR-12-MD-G08-B-W66-DM	124.78	

### Series HR-19 • BG 4 • Nominal Size 19

Port A	Dimensions ( <sup>mm</sup> / <sub>in</sub> )											Female Body Ordering Codes	Weight ( <sup>kg</sup> / <sub>lbs</sub> ) ca. per 100	Male Tip Ordering Codes	Weight ( <sup>kg</sup> / <sub>lbs</sub> ) ca. per 100	
	ØE	ØF	ØG	L1	L2	L4 min	L5	SW1	SW2	SW4						
Female Thread according to DIN 3852 - ISO 1179-1																
 G 3/4"	44,7	26	60	99	73	16	30	30	30	60	QRC-HR-19-F-G12-BT-W66	66	QRC-HR-19-M-G12-B-W66	59,90		
	1.76	1.02	2.36	3.90	2.87	.63	1.18	1.18	1.18	2.36		145.51		132.06		
	44,7	26	60	99	73	16	30	30	30	60		QRC-HR-19-FD-G12-BT-W66-DM		72,80	QRC-HR-19-MD-G12-B-W66-DM	68
	1.76	1.02	2.36	3.90	2.87	.63	1.18	1.18	1.18	2.36		160.50		QRC-HR-19-MD-G12-B-W66-DM	149.91	

### Series HR-25 • BG 6 • Nominal Size 25

Port A	Dimensions ( <sup>mm</sup> / <sub>in</sub> )											Female Body Ordering Codes	Weight ( <sup>kg</sup> / <sub>lbs</sub> ) ca. per 100	Male Tip Ordering Codes	Weight ( <sup>kg</sup> / <sub>lbs</sub> ) ca. per 100	
	ØE	ØF	ØG	L1	L2	L4 min	L5	SW1	SW2	SW4						
Female Thread according to DIN 3852 - ISO 1179-1																
 G 1"	58	36,8	77	106	81	18	30	40	40	77	QRC-HR-25-F-G16-BT-W66	117,90	QRC-HR-25-M-G16-B-W66	114,7		
	2.28	1.45	3.02	4.17	3.19	.71	1.18	1.57	1.57	3.02		259.93		252.87		
	58	36,8	77	106	81	18	30	40	40	77		QRC-HR-25-FD-G16-BT-W66-DM		125,70	QRC-HR-25-MD-G16-B-W66-DM	125,80
	2.28	1.45	3.02	4.17	3.19	.71	1.18	1.57	1.57	3.02		277.12		QRC-HR-25-MD-G16-B-W66-DM	277.34	

Note: The connection of the two halves of a coupling is achieved depending on the type. It is important to observe the positive engagement of plug-type couplings and the secure tightening of screw-type couplings to the limit stop of the thread. Forced or improper separation will result in malfunction of the coupling.



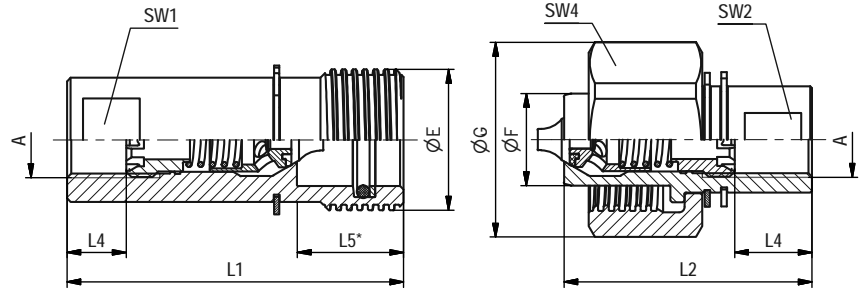

SW: Width across flats. All dimensions in mm (inch). Drawing similar Series HR-12.  
\* Insertion Female Body.

**Series HR-31 • BG 8 • Nominal Size 31,5**

Port A	Dimensions (mm/in)											Female Body	Weight (kg/lbs) ca. per 100	Male Tip	Weight (kg/lbs) ca. per 100
	ØE	ØF	ØG	L1	L2	L4 min	L5	SW1	SW2	SW4	Ordering Codes	Ordering Codes			
Female Thread according to DIN 3852 - ISO 1179-1															
	G 1 1/4"	66	47	88	118	88	20	35	48	48	88	QRC-HR-31-F-G20-BT-W66	160,60	QRC-HR-31-M-G20-B-W66	180,30
		2.60	1.85	3.46	4.65	3.46	.79	1.38	1.89	1.89	3.46		354.06		397.49
		66	47	88	118	88	20	35	48	48	88	QRC-HR-31-FD-G20-BT-W66-DM	171,10	QRC-HR-31-MD-G20-B-W66-DM	192,80
		2.60	1.85	3.46	4.65	3.46	.79	1.38	1.89	1.89	3.46		377.21		425.05

**Series HR-38 • BG 10 • Nominal Size 38**

Port A	Dimensions (mm/in)											Female Body	Weight (kg/lbs) ca. per 100	Male Tip	Weight (kg/lbs) ca. per 100
	ØE	ØF	ØG	L1	L2	L4 min	L5	SW1	SW2	SW4	Ordering Codes	Ordering Codes			
Female Thread according to DIN 3852 - ISO 1179-1															
	G 1 1/2"	75	57	93	121	90	22	35	55	55	93	QRC-HR-38-F-G24-BT-W66	200,60	QRC-HR-38-M-G24-B-W66	218,40
		2.95	2.24	3.66	4.76	3.54	.87	1.38	2.16	2.16	3.66		442.25		481.49
		75	57	93	121	90	22	35	55	55	93	QRC-HR-38-FD-G24-BT-W66-DM	213,90	QRC-HR-38-MD-G24-B-W66-DM	233,10
		2.95	2.24	3.66	4.76	3.54	.87	1.38	2.16	2.16	3.66		471.57		513.90

HR

Note: The connection of the two halves of a coupling is achieved depending on the type. It is important to observe the positive engagement of plug-type couplings and the secure tightening of screw-type couplings to the limit stop of the thread. Forced or improper separation will result in malfunction of the coupling.

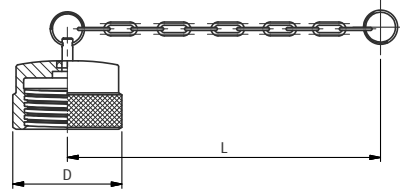
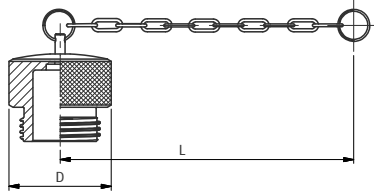

**Series HR • Dust Protection**

Dimensions (mm/in)			Material	Dust Plug for Male Tip
D1	D2	L		Ordering Codes
48		200	Plastic (Colour: Black)	<b>QRC-HR-10-DM-CN-KI-BK</b>
1.89		7.87		
51		200	Plastic (Colour: Black)	<b>QRC-HR-12-DM-CN-KI-BK</b>
2.01		7.87		
57		200	Plastic (Colour: Black)	<b>QRC-HR-19-DM-CN-KI-BK</b>
2.24		7.87		
68		200	Plastic (Colour: Black)	<b>QRC-HR-25-DM-CN-KI-BK</b>
2.68		7.87		
76		265	Plastic (Colour: Black)	<b>QRC-HR-31-DM-CN-KI-BK</b>
2.99		10.43		
86		265	Plastic (Colour: Black)	<b>QRC-HR-38-DM-CN-KI-BK</b>
3.39		10.43		

Dimensions (mm/in)			Material	Dust Cap for Female Body
D1	D2	L		Ordering Codes
48		200	Plastic (Colour: Black)	<b>QRC-HR-10-DF-CN-KI-BK</b>
1.89		7.87		
51		200	Plastic (Colour: Black)	<b>QRC-HR-12-DF-CN-KI-BK</b>
2.01		7.87		
57		200	Plastic (Colour: Black)	<b>QRC-HR-19-DF-CN-KI-BK</b>
2.24		7.87		
68		200	Plastic (Colour: Black)	<b>QRC-HR-25-DF-CN-KI-BK</b>
2.68		7.87		
76		265	Plastic (Colour: Black)	<b>QRC-HR-31-DF-CN-KI-BK</b>
2.99		10.43		
85		265	Plastic (Colour: Black)	<b>QRC-HR-38-DF-CN-KI-BK</b>
3.35		10.43		

In addition to the standard colours as stated above, plastic dust caps are also available in blue, green, yellow and black. Please use the color codes BU, GN, YE and BK respectively instead of RD.

Note: The connection of the two halves of a coupling is achieved depending on the type. It is important to observe the positive engagement of plug-type couplings and the secure tightening of screw-type couplings to the limit stop of the thread. Forced or improper separation will result in malfunction of the coupling.



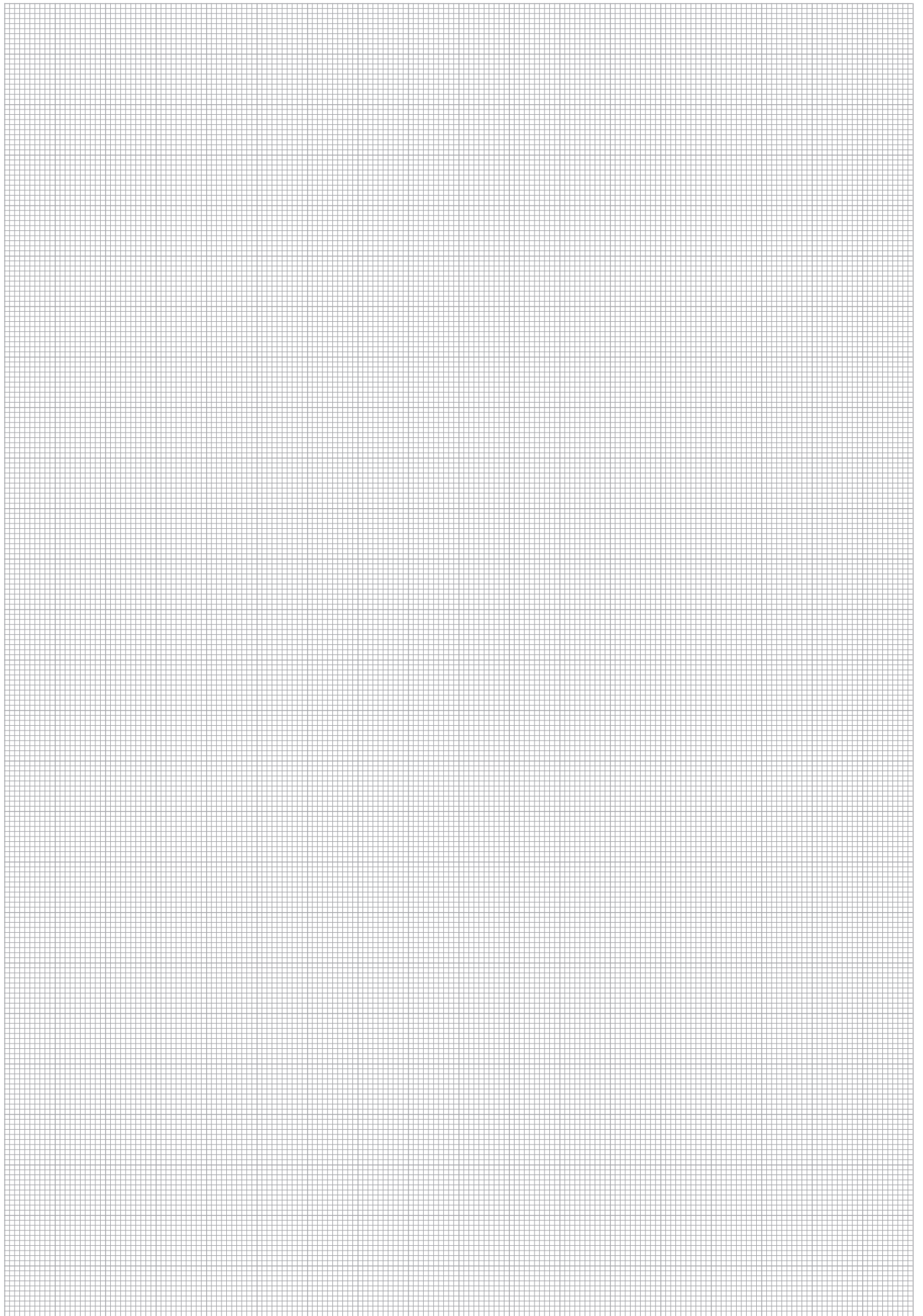

HR





Series HH - Carbon Steel

Series HH - Overview	154	Series HH-51 - BG 12 - Nominal Size 51	156
Series HH-10 - BG 2 - Nominal Size 10	155	Series HH - Dust Protection	157
Series HH-12 - BG 3 - Nominal Size 12,5	155		
Series HH-19 - BG 4 - Nominal Size 19	155		
Series HH-25 - BG 6 - Nominal Size 25	155		
Series HH-31 - BG 8 - Nominal Size 31,5	156		
Series HH-38 - BG 10 - Nominal Size 38	156		



HH



### Series HH ▪ Carbon Steel

Material	Carbon Steel
Surface Finishing	Zinc-Nickel
Standard Seal Material(s)	NBR (Buna-N®) <sup>2</sup>
Working Temperature	-25° C ... +100° C / -13° F ... +212° F
Valve Design	Poppet Valve
Connection	Screw
Disconnection	Screw
Connect Under Pressure	Male Tip or Female Body allowed
Application	Industrial Hydraulic, Rescue and Tensioning Hydraulics
ISO Interchange	-



<sup>2</sup>Alternative seal materials are available on request.

### Technical Data

Series	BG	DN Zoll	DN metric ISO 4397	Q <sub>max</sub>		Working Pressure		Bursting Pressure Connected		Female Body		Male Tip		Spillage	
				l/min	US GPM	bar	PSI	bar	PSI	bar	PSI	bar	PSI	ml	fl oz
HH-10	2	3/8"	10	18	4.76	650	9427	3000	43511	3000	43511	3000	43511	1,9	.0642
HH-12	3	1/2"	12,5	23	6.08	600	8702	2200	31908	2700	39160	2500	36260	2,7	.0913
HH-19	4	3/4"	19 (20)	45	11.89	500	7252	2100	30458	2600	37710	2400	34809	9,3	.3145
HH-25	6	1"	25	106	28.00	460	6672	2000	29008	2600	37710	2300	33359	16	.5410
HH-31	8	1 1/4"	31	189	49.93	360	5221	1500	21756	1500	21756	1500	21756	30	10.144
HH-38	10	1 1/2"	38	300	79.25	360	5221							54	18.260
HH-51	12	2"	51	757	199.98	210	3046							120	40.577

The indicated pressure ratings only apply to the coupling itself and depend on the connection type.

### Flow Characteristics

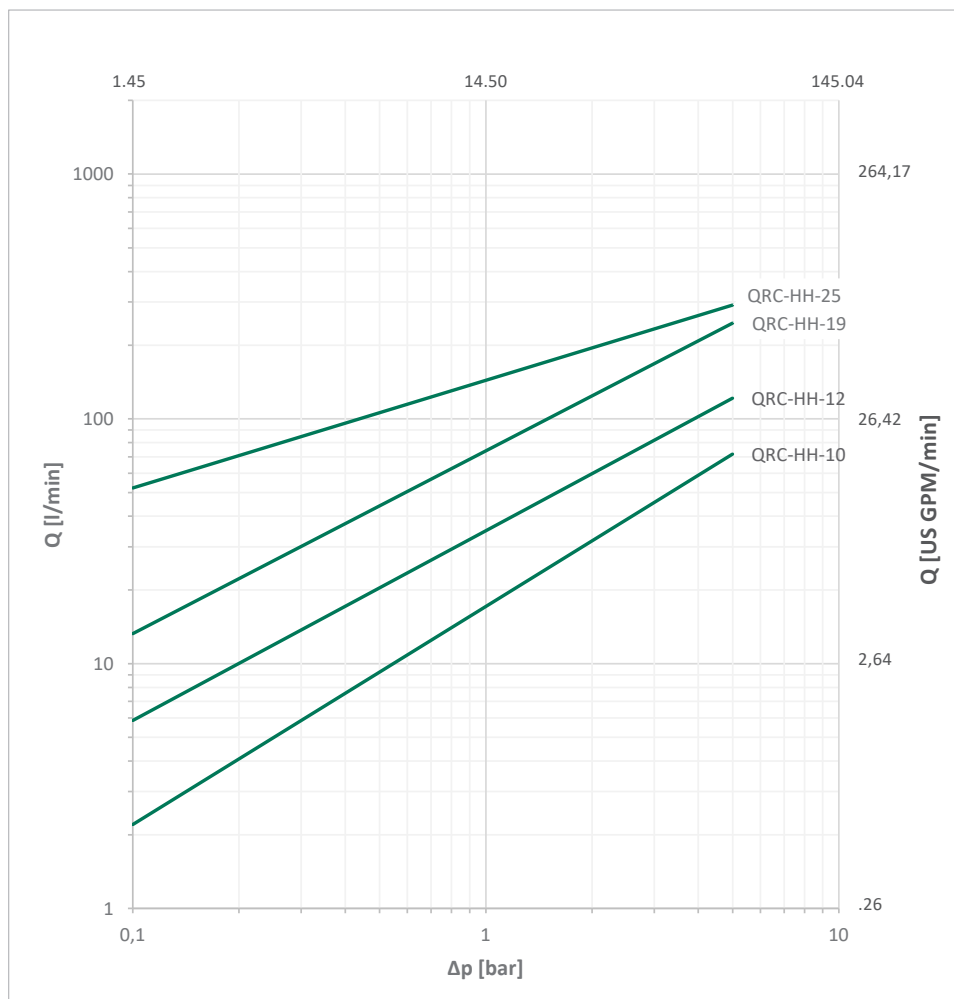

Please note: Unless otherwise stated, all flow characteristics have been determined with hydraulic oil with a kinematic viscosity of 28,8 - 35,2 mm<sup>2</sup>/s (28,8 - 35,2 cSt) and are only valid for components with non-reducing connections.



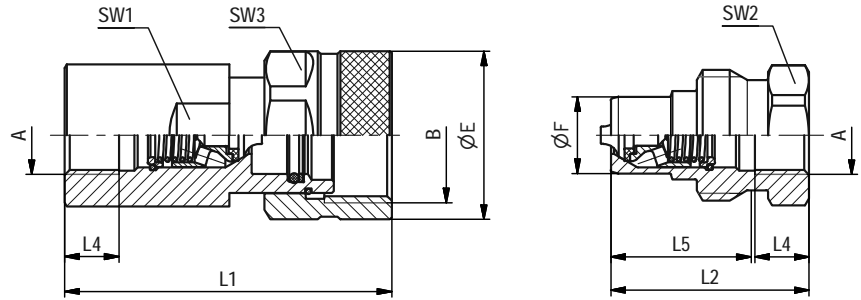

SW: Width across flats. All dimensions in mm (inch). Drawing similar Series HH-12.  
\* Insertion Male Tip.

### Series HH-10 • BG 2 • Nominal Size 10

Port A	Dimensions (mm/in)											Female Body	Weight (kg/lbs) ca. per 100	Male Tip	Weight (kg/lbs) ca. per 100
	ØE	ØF	B	L1	L2	L4 min	L5	SW1	SW2	SW3	Ordering Codes				
Female Thread according to DIN 3852 - ISO 1179-1 - ANSI B 1.20.3															
	G 3/8"	40	18,9	1 1/4" - 8 UN	75,6	48	16	34	30	32	36	QRC-HH-10-F-G06-BT-W3	36,86	QRC-HH-10-M-G06-B-W3	15,07
		.16	.74		2,98	1,89	.63	1,34	1,18	1,26	1,42		81,26		34,17
	NPTF 3/8" -18	40	18,9	1 1/4" - 8 UN	75,6	48		34	30	32	36	QRC-HH-10-F-NF06-BT-W3	34,60	QRC-HH-10-M-NF06-B-W3	15,70
		.16	.74		2,98	1,89		1,34	1,18	1,26	1,42		76,28		34,61

### Series HH-12 • BG 3 • Nominal Size 12,5

Port A	Dimensions (mm/in)											Female Body	Weight (kg/lbs) ca. per 100	Male Tip	Weight (kg/lbs) ca. per 100
	ØE	ØF	B	L1	L2	L4 min	L5	SW1	SW2	SW3	Ordering Codes				
Female Thread according to DIN 3852 - ISO 1179-1 - ANSI B 1.20.3															
	G 1/2"	45	20,5	1 3/8" - 8 UN	86,4	53	18	37,2	34	34	41	QRC-HH-12-F-G08-BT-W3	56,70	QRC-HH-12-M-G08-B-W3	18,82
		1,77	.81		3,40	2,09	.71	1,46	1,34	1,34	1,61		125,00		41,49
	NPTF 1/2" -14	45	20,5	1 3/8" - 8 UN	86,4	53		37,2	34	34	41	QRC-HH-12-F-NF08-BT-W3	58,20	QRC-HH-12-M-NF08-B-W3	18,00
		1,77	.81		3,40	2,09		1,46	1,34	1,34	1,61		128,31		39,68

### Series HH-19 • BG 4 • Nominal Size 19

Port A	Dimensions (mm/in)											Female Body	Weight (kg/lbs) ca. per 100	Male Tip	Weight (kg/lbs) ca. per 100
	ØE	ØF	B	L1	L2	L4 min	L5	SW1	SW2	SW3	Ordering Codes				
Female Thread according to DIN 3852 - ISO 1179-1 - ANSI B 1.20.3															
	G 3/4"	53,8	27,9	1 3/4" - 6 UN	105,5	63	21	47,3	41	46	50	QRC-HH-19-F-G12-BT-W3	93,00	QRC-HH-19-M-G12-B-W3	36,80
		2,12	1,10		4,15	2,48	0,83	1,86	1,61	1,81	1,97		205,03		80,25
	NPTF 3/4" -14	53,8	27,9	1 3/4" - 6 UN	105,5	63		47,3	41	46	50	QRC-HH-19-F-NF12-BT-W3	99,70	QRC-HH-19-M-NF12-B-W3	37,30
		2,12	1,10		4,15	2,48		1,86	1,61	1,81	1,97		219,80		82,23

### Series HH-25 • BG 6 • Nominal Size 25

Port A	Dimensions (mm/in)											Female Body	Weight (kg/lbs) ca. per 100	Male Tip	Weight (kg/lbs) ca. per 100
	ØE	ØF	B	L1	L2	L4 min	L5	SW1	SW2	SW3	Ordering Codes				
Female Thread according to DIN 3852 - ISO 1179-1 - ANSI B 1.20.3															
	G 1"	59	31,3	M52x4	123	72	23	56,5	50	50	55	QRC-HH-25-F-G16-BT-W3	137,90	QRC-HH-25-M-G16-B-W3	51,70
		2,32	1,23		4,84	2,83	.91	2,22	1,97	1,97	2,17		309,31		113,98
	NPTF 1" -11	59	31,3	M52x4	123	72		56,5	50	50	55	QRC-HH-25-F-NF16-BT-W3	148,10	QRC-HH-25-M-NF16-B-W3	54,00
	1/2	2,32	1,23		4,84	2,83		2,22	1,97	1,97	2,17		326,50		119,05

**HH**

Note: The connection of the two halves of a coupling is achieved depending on the type. It is important to observe the positive engagement of plug-type couplings and the secure tightening of screw-type couplings to the limit stop of the thread. Forced or improper separation will result in malfunction of the coupling.



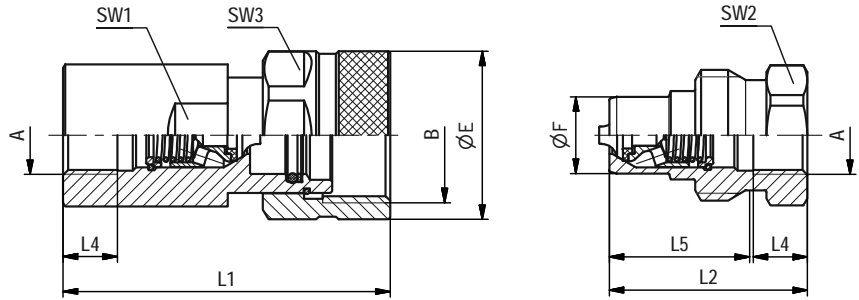

SW: Width across flats. All dimensions in mm (inch). Drawing similar Series HH-12.  
\* Insertion Male Tip.

**Series HH-31 • BG 8 • Nominal Size 31,5**

Port A	Dimensions (mm/in)										Female Body	Weight (kg/lbs) ca. per 100	Male Tip	Weight (kg/lbs) ca. per 100	
	ØE	ØF	B	L1	L2	L4 min	L5	SW1	SW2	SW3					Ordering Codes
Female Thread according to DIN 3852 - ISO 1179-1 - ANSI B 1.20.3															
	G 1 1/4"	78,5	43,9	M68x6	152,5	86	24	71,3	65	65	75	QRC-HH-31-F-G20-BT-W3	292,60	QRC-HH-31-M-G20-B-W3	105,50
		3,09	1,73		6,01	3,39	.94	2,81	2,56	2,56	2,95		632,73		231,49
	NPTF 1 1/4"	78,5	43,9	M68x6	152,5	86		71,3	65	65	75	QRC-HH-31-F-NF20-BT-W3	295	QRC-HH-31-M-NF20-B-W3	109,20
	-11 1/2	3,09	1,73		6,01	3,39		2,81	2,56	2,56	2,95		650,36		240,74

**Series HH-38 • BG 10 • Nominal Size 38**

Port A	Dimensions (mm/in)										Female Body	Weight (kg/lbs) ca. per 100	Male Tip	Weight (kg/lbs) ca. per 100	
	ØE	ØF	B	L1	L2	L4 min	L5	SW1	SW2	SW3					Ordering Codes
Female Thread according to DIN 3852 - ISO 1179-1 - ANSI B 1.20.3															
	G 1 1/2"	98	53,4	M78x6	172	95	27	79	75	80	90	QRC-HH-38-F-G24-BT-W3	444,40	QRC-HH-38-M-G24-B-W3	173,70
		3,86	2,10		6,77	3,74	1,06	3,11	2,95	3,15	3,54		978,85		374,79
	NPTF 1 1/2"	98	53,4	M78x6	172	95		79	75	80	90	QRC-HH-38-F-NF24-BT-W3	447	QRC-HH-38-M-NF24-B-W3	172
	-11 1/2	3,86	2,10		6,77	3,74		3,11	2,95	3,15	3,54		985,47		379,20

**Series HH-51 • BG 12 • Nominal Size 51**

Port A	Dimensions (mm/in)										Female Body	Weight (kg/lbs) ca. per 100	Male Tip	Weight (kg/lbs) ca. per 100	
	ØE	ØF	B	L1	L2	L4 min	L5	SW1	SW2	SW3					Ordering Codes
Female Thread according to DIN 3852 - ISO 1179-1 - ANSI B 1.20.3															
	G 2"	129	81,8	M115x8	206,5	118	27	97,1	100	110	125	QRC-HH-51-F-G32-BT-W3	856,50	QRC-HH-51-M-G32-B-W3	492,80
		5,07	3,22		8,13	4,65	1,06	3,82	3,94	4,33	4,92		1888,26		1086,88
	NPTF 2" -11 1/2	129	81,8	M115x8	206,5	118		97,1	100	110	125	QRC-HH-51-F-NF32-BT-W3	892,00	QRC-HH-51-M-NF32-B-W3	507
		5,07	3,22		8,13	4,65		3,82	3,94	4,33	4,92		1966,52		1117,74

Note: The connection of the two halves of a coupling is achieved depending on the type. It is important to observe the positive engagement of plug-type couplings and the secure tightening of screw-type couplings to the limit stop of the thread. Forced or improper separation will result in malfunction of the coupling.

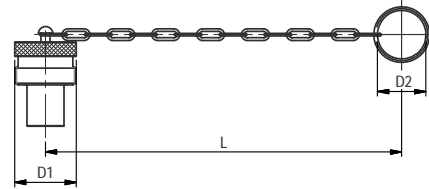
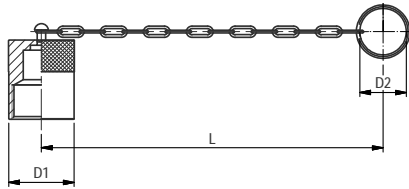

**Series HH • Dust Protection**

Dimensions (mm/in)			Material	Dust Cap for Male Tip
D1	D2	L		Ordering Codes
34	30	240	Aluminium with chain	QRC-HH-10-DM-30/CN-W89-SI
1.34	1.18	9.45		
38	30	240	Aluminium with chain	QRC-HH-12-DM-30/CN-W89-SI
1.50	1.18	9.45		
48	41	290	Aluminium with chain	QRC-HH-19-DM-41/CN-W89-SI
1.89	1.61	11.42		
58	48	300	Aluminium with chain	QRC-HH-25-DM-48/CN-W89-SI
2.28	1.89	11.81		
81	48	400	Aluminium with chain	QRC-HH-31-DM-48/CN-W89-SI
3.19	1.89	15.75		
85	46	260	Aluminium with chain	QRC-HH-38-DM-46/CN-W89-SI
3.35	1.81	10.24		
100	46	300	Aluminium with chain	QRC-HH-51-DM-46/CN-W89-SI
3.94	1.81	11.81		

Dimensions (mm/in)			Material	Dust Plug for Female Body
D1	D2	L		Ordering Codes
34	30	190	Aluminium with chain	QRC-HH-10-DF-30/CN-W89-SI
1.34	1.18	7.48		
34	30	240	Aluminium with chain	QRC-HH-12-DF-30/CN-W89-SI
1.34	1.18	9.45		
53	48	300	Aluminium with chain	QRC-HH-19-DF-48/CN-W89-SI
2.09	1.89	11.81		
53	41	290	Aluminium with chain	QRC-HH-25-DF-41/CN-W89-SI
2.09	1.61	11.42		
71	48	400	Aluminium with chain	QRC-HH-31-DF-48/CN-W89-SI
2.80	1.89	15.75		
98	46	210	Aluminium with chain	QRC-HH-38-DF-46/CN-W89-SI
3.86	1.81	8.27		
115	46	270	Aluminium with chain	QRC-HH-51-DF-46/CN-W89-SI
4.53	1.81	10.63		

**HH**

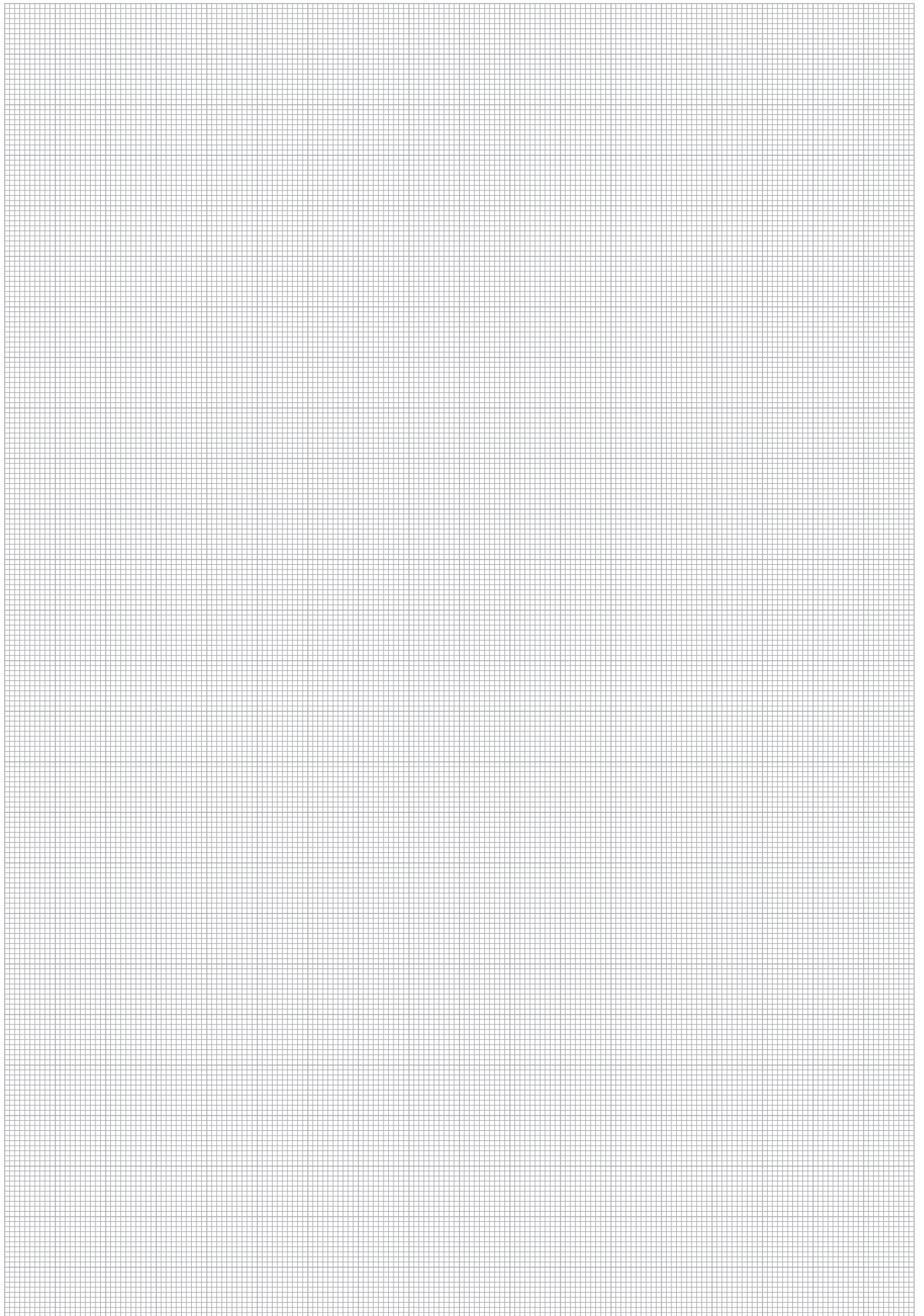
HH



Series HH • Stainless Steel

Series HH • Overview	160
Series HH-10 • BG 2 • Nominal Size 10	161
Series HH-12 • BG 3 • Nominal Size 12,5	161
Series HH-19 • BG 4 • Nominal Size 19	161
Series HH-25 • BG 6 • Nominal Size 25	161
Series HH-31 • BG 8 • Nominal Size 31,5	162
Series HH-38 • BG 10 • Nominal Size 38	162

Series HH-51 • BG 12 • Nominal Size 51	162
Series HH • Dust Protection	163



HH



### Series HH ▪ Stainless Steel

Material	Stainless Steel V4A (AISI 316)
Surface Finishing	-
Standard Seal Material(s)	FKM (Viton®) <sup>2</sup>
Working Temperature	-25° C ... +200° C / -13° F ... +392° F
Valve Design	Poppet Valve
Connection	Screw
Disconnection	Screw
Connect Under Pressure	Male Tip or Female Body allowed
Application	Industrial Hydraulic, Offshore, Rescue and Tensioning Hydraulics
ISO Interchange	-



<sup>2</sup>Alternative seal materials are available on request.

### Technical Data

Series	BG	DN Zoll Inch	DN metric ISO 4397	Q <sub>max</sub>		Working Pressure		Bursting Pressure Connected		Female Body		Male Tip		Spillage	
				l/min	US GPM	bar	PSI	bar	PSI	bar	PSI	bar	PSI	ml	fl oz
HH-10	2	3/8"	10	18	4.76	650	9427	2600	37730	2000	29008	2300	33359	1,9	.0642
HH-12	3	1/2"	12,5	23	6.08	600	8702	2500	36260	2700	39160	2100	30458	2,7	.0913
HH-19	4	3/4"	19 (20)	45	11.89	500	7252	2400	34809	1700	24656	2100	30458	9,3	.3145
HH-25	6	1"	25	106	28.00	460	6672	1500	21756	1900	27557	1600	23206	16	.5410
HH-31	8	1 1/4"	31	189	49.93	360	5221	1000	14504	1000	14504	1000	14504	30	10.144
HH-38	10	1 1/2"	38	300	79.25	360	5221	900	13053	900	13053	900	13053	54	18.260
HH-51	12	2"	51	757	199.98	210	3046	500	7252	500	7252	500	7252	120	40.577

The indicated pressure ratings only apply to the coupling itself and depend on the connection type.

### Flow Characteristics

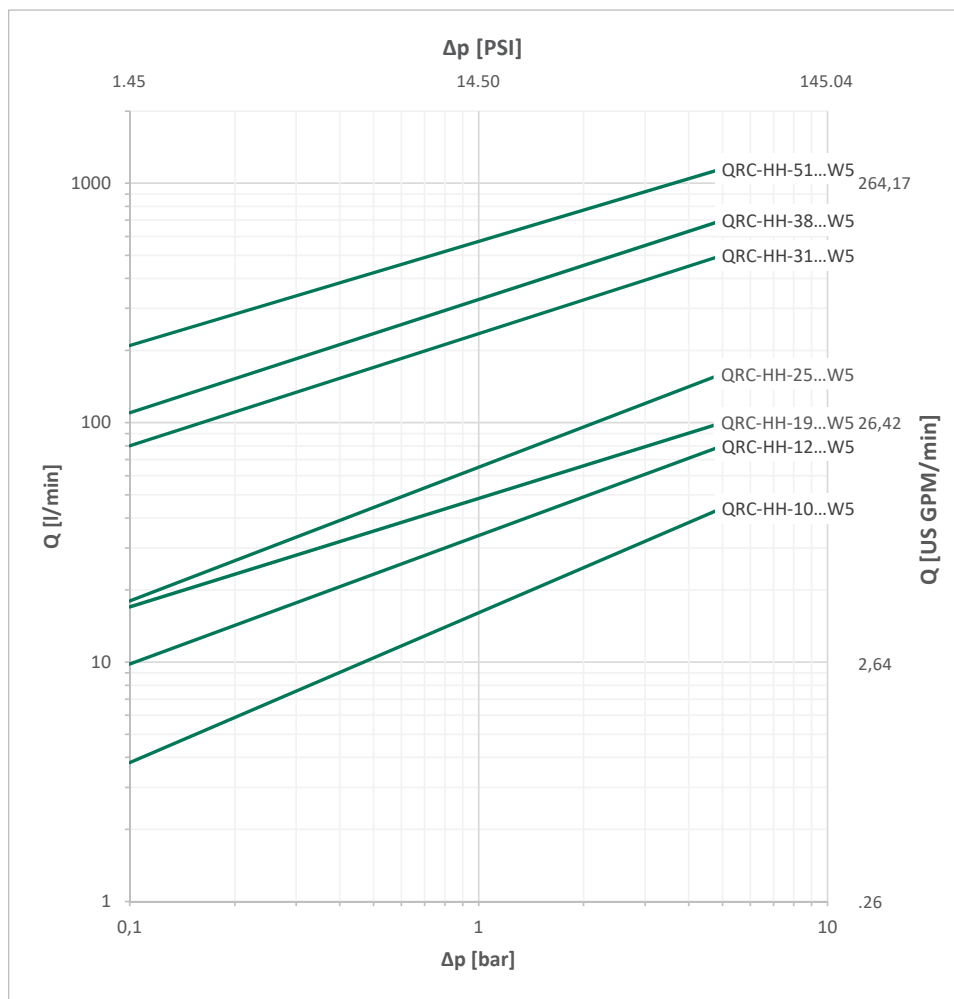

Please note: Unless otherwise stated, all flow characteristics have been determined with hydraulic oil with a kinematic viscosity of 28,8 - 35,2 mm<sup>2</sup>/s (28,8 - 35,2 cSt) and are only valid for components with non-reducing connections.





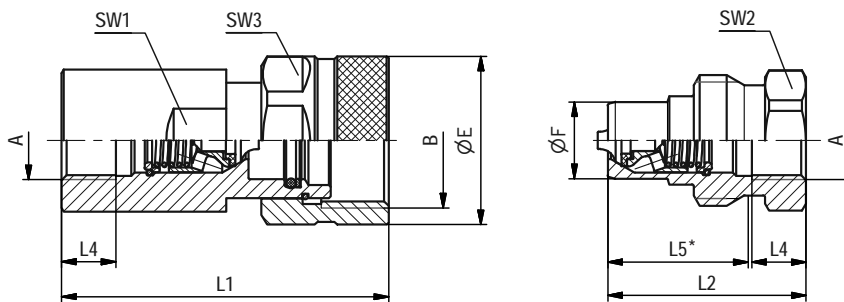

SW: Width across flats. All dimensions in mm (inch). Drawing similar Series HH-12.  
\* Insertion Male Tip.

### Series HH-10 • BG 2 • Nominal Size 10

Port A	Dimensions (mm/in)											Female Body	Weight (kg/lbs) ca. per 100	Male Tip	Weight (kg/lbs) ca. per 100
	ØE	ØF	B	L1	L2	L4 min	L5	SW1	SW2	SW3	Ordering Codes				
Female Thread according to DIN 3852 - ISO 1179-1 - ANSI B 1.20.3															
	G 3/8"	40	19	1 1/4" - 8 UN	76	48	12	34	27	32	36	QRC-HH-10-F-G06-VT-W5	34,40	QRC-HH-10-M-G06-V-W5	15,50
		1.57	.75		2.99	1.89	.47	1.34	1.06	1.26	1.42		75.84		34.17
	NPTF 3/8" - 18	40	19	1 1/4" - 8 UN	76	48		34	27	32	36	QRC-HH-10-F-NF06-VT-W5	34,60	QRC-HH-10-M-NF06-V-W5	15,70
		1.57	.75		2.99	1.89		1.34	1.06	1.26	1.42	QRC-HH-10-F-NF06-VT-W5	76.28		34.61

### Series HH-12 • BG 3 • Nominal Size 12,5

Port A	Dimensions (mm/in)											Female Body	Weight (kg/lbs) ca. per 100	Male Tip	Weight (kg/lbs) ca. per 100
	ØE	ØF	B	L1	L2	L4 min	L5	SW1	SW2	SW3	Ordering Codes				
Female Thread according to DIN 3852 - ISO 1179-1 - ANSI B 1.20.3															
	G 1/2"	45	20,5	1 3/8" - 8 UN	87	53	14	37,5	34	34	41	QRC-HH-12-F-G08-VT-W5	57,60	QRC-HH-12-M-G08-V-W5	17,70
		1.77	.81		3.43	2.09	.55	1.48	1.34	1.34	1.61		126.99		39.02
	NPTF 1/2" - 14	45	20,5	1 3/8" - 8 UN	87	53		37,5	34	34	41	QRC-HH-12-F-NF08-VT-W5	58,20	QRC-HH-12-M-NF08-V-W5	18
		1.77	.81		3.43	2.09		1.48	1.34	1.34	1.61	QRC-HH-12-F-NF08-VT-W5	128.31		39.68

### Series HH-19 • BG 4 • Nominal Size 19

Port A	Dimensions (mm/in)											Female Body	Weight (kg/lbs) ca. per 100	Male Tip	Weight (kg/lbs) ca. per 100
	ØE	ØF	B	L1	L2	L4 min	L5	SW1	SW2	SW3	Ordering Codes				
Female Thread according to DIN 3852 - ISO 1179-1 - ANSI B 1.20.3															
	G 3/4"	55	27,9	1 3/4" - 6 UN	106	63	16	48	41	46	50	QRC-HH-19-F-G12-VT-W5	98,80	QRC-HH-19-M-G12-V-W5	36,40
		2.16	1.10		4.17	2.48	.63	1.89	1.61	1.81	1.97		217.82		80.25
	NPTF 3/4" - 14	55	27,9	1 3/4" - 6 UN	106	63		48	41	46	50	QRC-HH-19-F-NF12-VT-W5	99,70	QRC-HH-19-M-NF12-V-W5	37,30
		2.16	1.10		4.17	2.48		1.89	1.61	1.81	1.97	QRC-HH-19-F-NF12-VT-W5	219.80		82.23

### Series HH-25 • BG 6 • Nominal Size 25

Port A	Dimensions (mm/in)											Female Body	Weight (kg/lbs) ca. per 100	Male Tip	Weight (kg/lbs) ca. per 100
	ØE	ØF	B	L1	L2	L4 min	L5	SW1	SW2	SW3	Ordering Codes				
Female Thread according to DIN 3852 - ISO 1179-1 - ANSI B 1.20.3															
	G 1"	60	31,2	M52x4	123	72	18	56	50	50	55	QRC-HH-25-F-G16-VT-W5	146,50	QRC-HH-25-M-G16-V-W5	52,40
		2.36	1.23		4.84	2.83	.71	2.20	1.97	1.97	2.16		322.98		115.52
	NPTF 1" - 11	60	31,2	M52x4	123	72		56	50	50	55	QRC-HH-25-F-NF16-VT-W5	148,10	QRC-HH-25-M-NF16-V-W5	54
	1/2	2.36	1.23		4.84	2.83		2.20	1.97	1.97	2.16	QRC-HH-25-F-NF16-VT-W5	326.50		119.05

**HH**

Note: The connection of the two halves of a coupling is achieved depending on the type. It is important to observe the positive engagement of plug-type couplings and the secure tightening of screw-type couplings to the limit stop of the thread. Forced or improper separation will result in malfunction of the coupling.



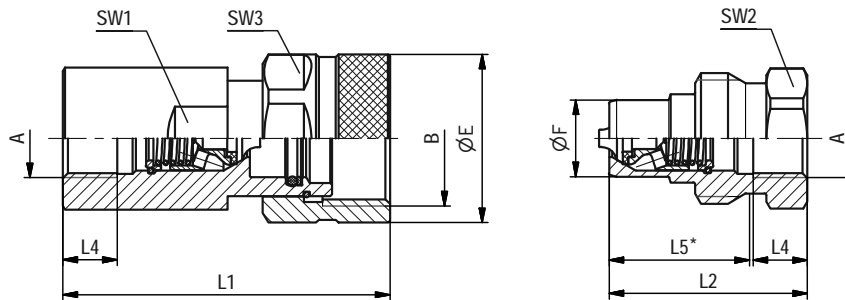

SW: Width across flats. All dimensions in mm (inch). Drawing similar Series HH-12.  
\* Insertion Male Tip.

### Series HH-31 • BG 8 • Nominal Size 31,5

Port A	Dimensions (mm/in)		Female Body	Weight (kg/lbs) ca. per 100	Male Tip	Weight (kg/lbs) ca. per 100									
	ØE	ØF					B	L1	L2	L4 min	L5	SW1	SW2	SW3	Ordering Codes
Female Thread according to DIN 3852 - ISO 1179-1 - ANSI B 1.20.3															
	G 1 1/4"	80 3.15	44 1.73	M68x6	153 6.02	86 3.39	20 .79	72 2.83	65 2.56	65 2.56	75 2.95	QRC-HH-31-F-G20-VT-W5	293,30 646.62	QRC-HH-31-M-G20-V-W5	107,40 236.78
	NPTF 1 1/4" -11 1/2	80 3.15	44 1.73	M68x6	153 6.02	86 3.39		72 2.83	65 2.56	65 2.56	75 2.95	QRC-HH-31-F-NF20-VT-W5	295 650.36	QRC-HH-31-M-NF20-V-W5	109,20 240.74

### Series HH-38 • BG 10 • Nominal Size 38

Port A	Dimensions (mm/in)		Female Body	Weight (kg/lbs) ca. per 100	Male Tip	Weight (kg/lbs) ca. per 100									
	ØE	ØF					B	L1	L2	L4 min	L5	SW1	SW2	SW3	Ordering Codes
Female Thread according to DIN 3852 - ISO 1179-1 - ANSI B 1.20.3															
	G 1 1/2"	98 3.86	53,4 2.10	M78x6	172 6.77	95 3.74	22 .87	80 3.15	75 2.95	80 3.15	90 3.54	QRC-HH-38-F-G24-VT-W5	455 1003.10	QRC-HH-38-M-G24-V-W5	173,40 382.28
	NPTF 1 1/2" -11 1/2	98 3.86	53,4 2.10	M78x6	172 6.77	95 3.74		80 3.15	75 2.95	80 3.15	90 3.54	QRC-HH-38-F-NF24-VT-W5	457 1007.51	QRC-HH-38-M-NF24-V-W5	173 381.40

### Series HH-51 • BG 12 • Nominal Size 51

Port A	Dimensions (mm/in)		Female Body	Weight (kg/lbs) ca. per 100	Male Tip	Weight (kg/lbs) ca. per 100									
	ØE	ØF					B	L1	L2	L4 min	L5	SW1	SW2	SW3	Ordering Codes
Female Thread according to DIN 3852 - ISO 1179-1 - ANSI B 1.20.3															
	G 2"	129 5.07	81,8 3.22	M115x8	205 8.07	118 4.65	24 .94	96 3.78	100 3.93	110 4.33	125 4.92	QRC-HH-51-F-G32-VT-W5	888 1957.71	QRC-HH-51-M-G32-V-W5	503 1108.93
	NPTF 2" -11 1/2	129 5.07	81,8 3.22	M115x8	205 8.07	118 4.65		96 3.78	100 3.93	110 4.33	125 4.92	QRC-HH-51-F-NF32-VT-W5	892 1966.52	QRC-HH-51-M-NF32-V-W5	507 1117.74

Note: The connection of the two halves of a coupling is achieved depending on the type. It is important to observe the positive engagement of plug-type couplings and the secure tightening of screw-type couplings to the limit stop of the thread. Forced or improper separation will result in malfunction of the coupling.

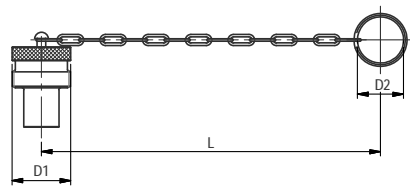
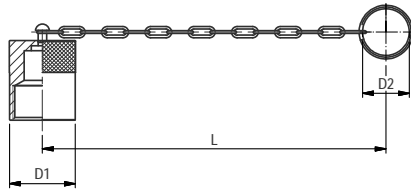

**Series HH • Dust Protection**

Dimensions (mm/in)			Material	Dust Cap for Male Tip
D1	D2	L		Ordering Codes
34	30	240	Aluminium with chain	QRC-HH-10-DM-30/CN-W89-SI
1.34	1.18	9.45		
38	30	240	Aluminium with chain	QRC-HH-12-DM-30/CN-W89-SI
1.50	1.18	9.45		
48	41	290	Aluminium with chain	QRC-HH-19-DM-41/CN-W89-SI
1.89	1.61	11.42		
58	48	300	Aluminium with chain	QRC-HH-25-DM-48/CN-W89-SI
2.28	1.89	11.81		
81	48	400	Aluminium with chain	QRC-HH-31-DM-48/CN-W89-SI
3.19	1.89	15.75		
85	46	260	Aluminium with chain	QRC-HH-38-DM-46/CN-W89-SI
3.35	1.81	10.24		
100	46	300	Aluminium with chain	QRC-HH-51-DM-46/CN-W89-SI
3.94	1.81	11.81		

Dimensions (mm/in)			Material	Dust Plug for Female Body
D1	D2	L		Ordering Codes
34	30	240	Aluminium with chain	QRC-HH-10-DF-30/CN-W89-SI
1.34	1.18	9.45		
34	30	240	Aluminium with chain	QRC-HH-12-DF-30/CN-W89-SI
1.34	1.18	9.45		
53	48	300	Aluminium with chain	QRC-HH-19-DF-48/CN-W89-SI
2.09	1.89	11.81		
53	41	290	Aluminium with chain	QRC-HH-25-DF-41/CN-W89-SI
2.09	1.61	11.42		
71	48	400	Aluminium with chain	QRC-HH-31-DF-48/CN-W89-SI
2.80	1.89	15.75		
98	46	210	Aluminium with chain	QRC-HH-38-DF-46/CN-W89-SI
3.86	1.81	8.27		
115	46	270	Aluminium with chain	QRC-HH-51-DF-46/CN-W89-SI
4.53	1.81	10.63		

**HH**

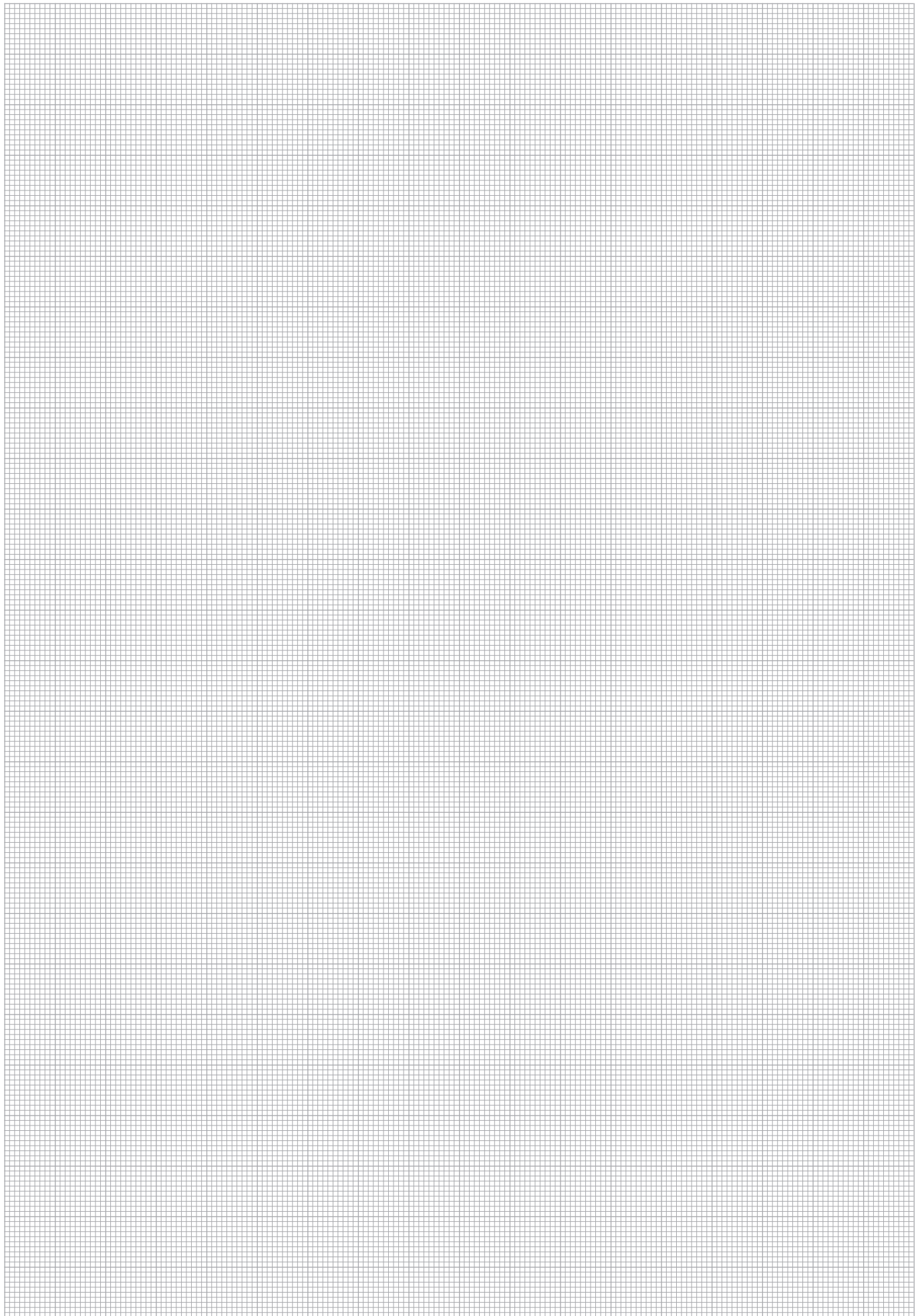
HH



Series HI - Carbon Steel

Series HI - Overview	166
Series HI-06 - BG 1 - Nominal Size 6,3	167
Series HI-10 - BG 2 - Nominal Size 10	167
Series HI - Dust Protection	168



HI



### Series HI (HIB) • Carbon Steel

Material	Carbon Steel
Surface Finishing	Zinc-Nickel
Standard Seal Material(s)	NBR (Buna-N®), PU <sup>2</sup>
Working Temperature	-25° C ... +100° C / -13° F ... +212° F
Valve Design	Poppet Valve (HI), Ball Valve (HIB) (optional)
Connection	Screw
Disconnection	Screw
Connect Under Pressure	not allowed
Application	Industrial Hydraulic, Rescue and Tensioning Hydraulics
ISO Interchange	ISO 14540



<sup>2</sup>Alternative seal materials are available on request.

### Technical Data

Series	BG	DN Zoll	DN metric ISO 4397	Q <sub>max</sub>		Working Pressure		Bursting Pressure Connected		Female Body		Male Tip		Spillage	
				l/min	US GPM	bar	PSI	bar	PSI	bar	PSI	bar	PSI	ml	fl oz
HI-06	1	1/4"	6,3	10	2.64	720	10443	2160	31328	2160	31328	2160	31328	0,5	.0176
HI-10	2	3/8"	10	20	5.28	720	10443	2160	31328	2160	31328	2160	31328	1	.0352
HIB-06	1	1/4"	6,3	10	2.64	720	10443	2160	31328	1440	20885	1440	20885	0,5	.0176
HIB-10	2	3/8"	10	20	5.28	720	10443	2160	31328	1440	20885	1440	20885	1	.0352

The indicated pressure ratings only apply to the coupling itself and depend on the connection type.

### Flow Characteristics

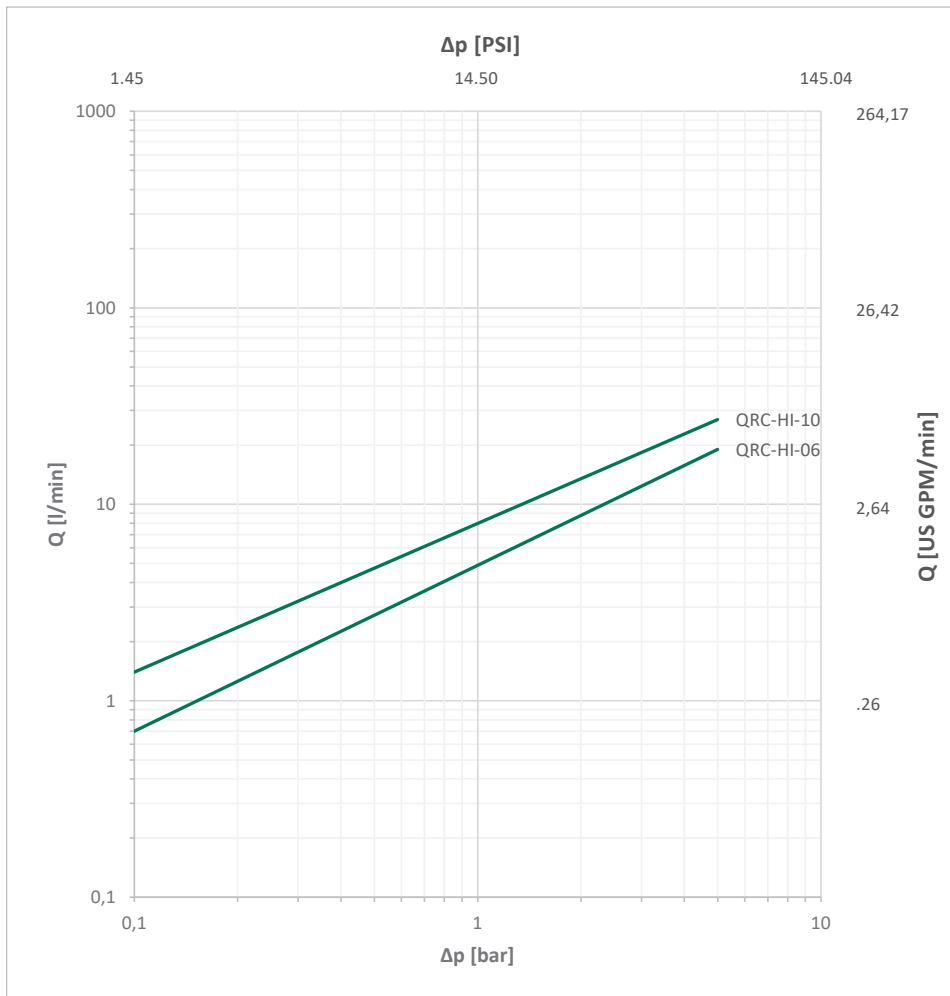



Please note: Unless otherwise stated, all flow characteristics have been determined with hydraulic oil with a kinematic viscosity of 28,8 - 35,2 mm<sup>2</sup>/s (28,8 - 35,2 cSt) and are only valid for components with non-reducing connections.

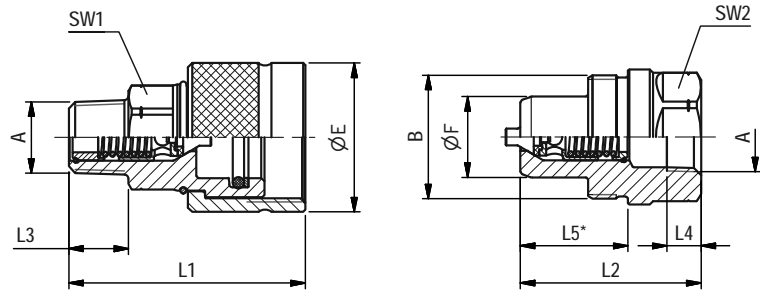



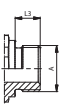

SW: Width across flats. All dimensions in mm (inch). Drawing similar Series HI-10.  
\* Insertion Male Tip.

### Series HI-06 ▪ BG 1 ▪ Nominal Size 6,3

Port A	Dimensions (mm/in)								Female Body Ordering Codes	Weight ( <sup>kg</sup> /lbs) ca. per 100	Male Tip Ordering Codes	Weight ( <sup>kg</sup> /lbs) ca. per 100
	ØE	ØF	B	L1	L2	L4 min	L5	SW1				
<b>Male Thread according to ANSI B 1.20.3</b>												
	NPTF 1/4" -18	28,6		1" - 18 UNS	59,7			22	QRC-HI-06-F-NF04M-S1-W3	29,10		
		1.13			2.35		.87	64.15				
<b>Female Thread according to DIN 3852 - ISO 1179-1 - ANSI B 1.20.3</b>												
	NPTF 1/4" -18	15,9	1" - 18 UNS	32,5		18,8	19	QRC-HI-06-M-NF04-BP-W3		13		28.66
		.63		1.28	.74	.75	28.66					

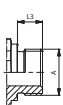
### Series HI-10 ▪ BG 2 ▪ Nominal Size 10

Port A	Dimensions (mm/in)								Female Body Ordering Codes	Weight ( <sup>kg</sup> /lbs) ca. per 100	Male Tip Ordering Codes	Weight ( <sup>kg</sup> /lbs) ca. per 100
	ØE	ØF	B	L1	L2	L4 min	L5	SW1				
<b>Male Thread according to ANSI B 1.20.3</b>												
	NPTF 3/8" -18	35	1" 3/16-16UN	73,5			25	QRC-HI-10-F-NF06M-S1-W3	22,38			
		1.38		2.89	.98	49.34						
<b>Female Thread according to ANSI B 1.20.3</b>												
	NPTF 3/8" -18	19	1" 3/16-16UN	35		25	32	QRC-HI-10-M-NF06-BP-W3		13,83		30.49
		.75		1.38	.98	1.26	30.49					

In addition to the version with poppet valve is a version with ball valve available.  
Please use for these version the code HIB instead of HI.

HI

Note: The connection of the two halves of a coupling is achieved depending on the type. It is important to observe the positive engagement of plug-type couplings and the secure tightening of screw-type couplings to the limit stop of the thread. Forced or improper separation will result in malfunction of the coupling.



Series HI• Dust Protection

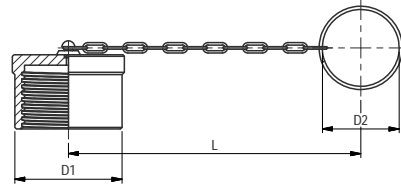
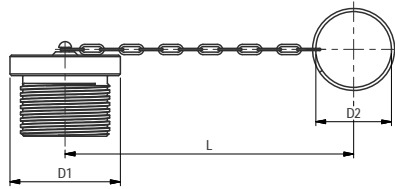

Dimensions (mm/in)			Material	Dust Plug for Female Body
D1	D2	L		Ordering Codes
28,6	14	161	Carbon Steel with chain	QRC-HI-06-DM-14/CN-W3
1.13	.55	6.34		
35	14	161	Carbon Steel with chain	QRC-HI-10-DM-14/CN-W3
1.38	.55	6.34		

Dimensions (mm/in)			Material	Dust Cap for Male Tip
D1	D2	L		Ordering Codes
28	14	161	Carbon Steel with chain	QRC-HI-06-DF-14/CN-W3
1.10	.55	6.34		
35	14	161	Carbon Steel with chain	QRC-HI-10-DF-14/CN-W3
1.38	.55	6.34		

\* Available on request.





Series HT - Carbon Steel

Series HT - Overview	170
Series HT-19 - BG 4 - Nominal Size 19	171
Series HT-25 - BG 6 - Nominal Size 25	171
Series HT - Dust Protection	171



HT



Series HT • Carbon Steel

Material	Carbon Steel
Surface Finishing	Zinc-Nickel
Standard Seal Material(s)	NBR (Buna-N®) <sup>2</sup>
Working Temperature	-25° C ... +100° C / -13° F ... +212° F
Valve Design	Poppet Valve
Connection	Screw
Disconnection	Screw
Connect Under Pressure	not allowed
Application	Industrial Hydraulic
ISO Interchange	-



Male Tip Female Body

<sup>2</sup>Alternative seal materials are available on request.

Technical Data

Series	BG	DN Zoll	DN metric ISO 4397	Q <sub>max</sub>		Working Pressure		Bursting Pressure Connected		Female Body		Male Tip		Spillage	
				l/min	US GPM	bar	PSI	bar	PSI	bar	PSI	bar	PSI	ml	fl oz
HT-19	4	3/4"	19 (20)	240	63.40	350	5076	1300	18855	1000	14504	1000	14504	10	.3381
HT-25	6	1"	25	320	84.54	300	4351	1000	14504	1000	14504	1000	14504	15	.5072

The indicated pressure ratings only apply to the coupling itself and depend on the connection type.

Flow Characteristics

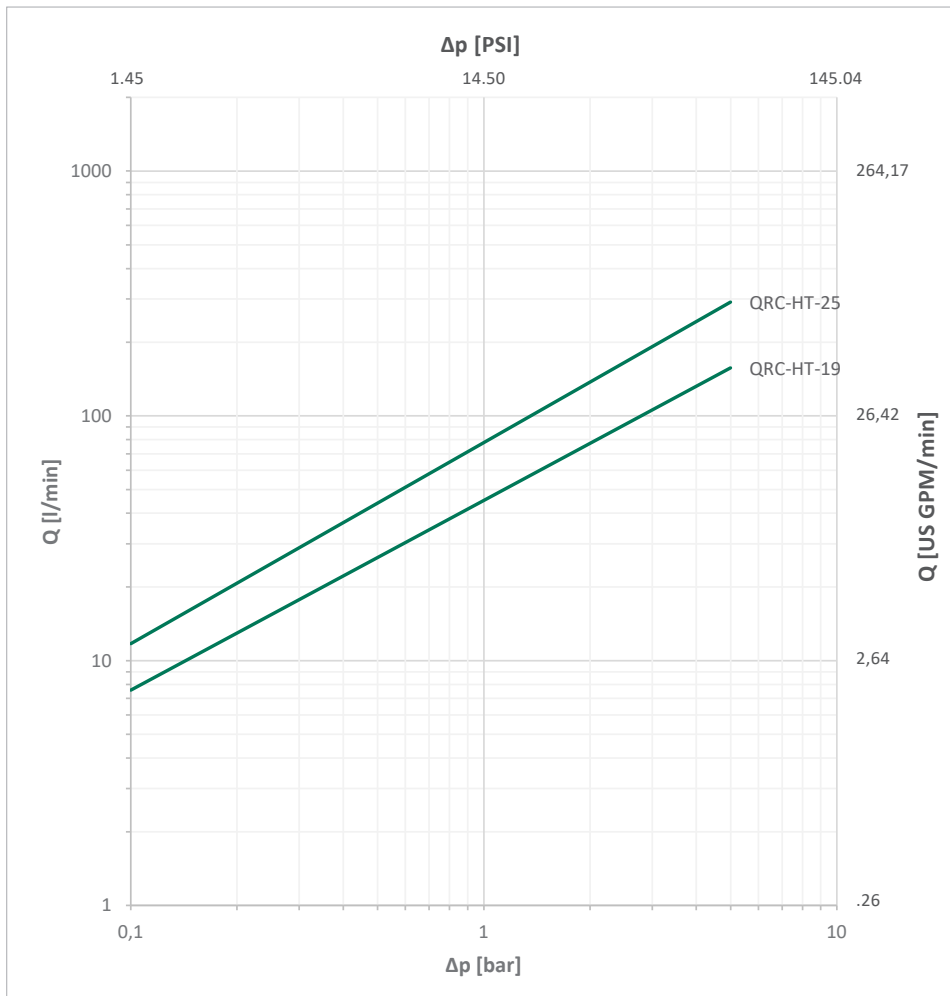

Please note: Unless otherwise stated, all flow characteristics have been determined with hydraulic oil with a kinematic viscosity of 28,8 - 35,2 mm<sup>2</sup>/s (28,8 - 35,2 cSt) and are only valid for components with non-reducing connections.

HT



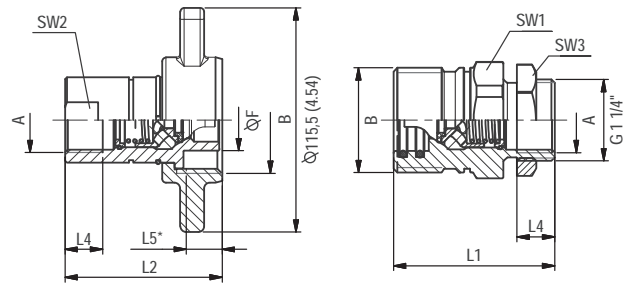

SW: Width across flats. All dimensions in mm (inch). Drawing similar Series HT-25.  
\* Insertion Male Tip.

### Series HT-19 • BG 4 • Nominal Size 19

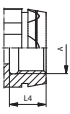
Port A	Dimensions (mm/in)											Female Body	Weight (kg/lbs) ca. per 100	Male Tip	Weight (kg/lbs) ca. per 100
	ØB	ØF	L1	L2	L4 min	L5	SW1	SW2	SW3	Ordering Codes	Ordering Codes				
Female Thread according to DIN 3852 - ISO 1179-1															
	G 3/4"	1 3/4" - 12 UN	25,3	78	78	19	23,5	33	46	50	QRC-HT-19-F-G12-B-W3	72,30 159.39	QRC-HT-19-M-G12-B-W3	81,00 178.57	
			.99	3.07	3.07	.75	.93	1.30	1.81	1.97					

### Series HT-25 • BG 6 • Nominal Size 25

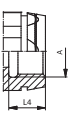
Port A	Dimensions (mm/in)											Female Body	Weight (kg/lbs) ca. per 100	Male Tip	Weight (kg/lbs) ca. per 100
	ØB	ØF	L1	L2	L4 min	L5	SW1	SW2	SW3	Ordering Codes	Ordering Codes				
Female Thread according to DIN 3852 - ISO 1179-1															
	G 1"	UNS 2 1/8"	31,75	83	83	18	21	40	55	50	QRC-HT-25-F-G16-B-W3	92,40 203.71	QRC-HT-25-M-G16-B-W3	83,70 184.52	
			1.25	3.27	3.27	.71	.83	1.57	2.17	1.97					

### Series HT • Dust Protection

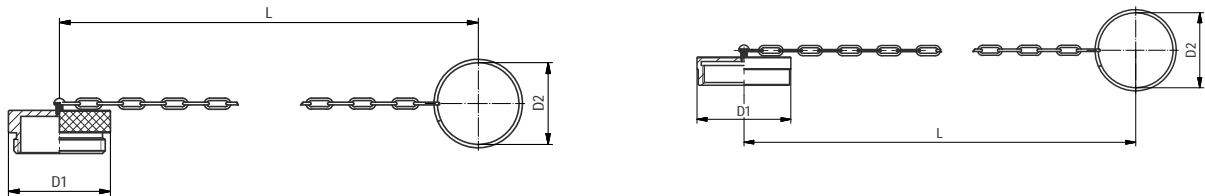

Dimensions (mm/in)			Material	Dust Plug for Female Body
D1	D2	L		Ordering Codes
48,2	45	205	Carbon Steel with Steel cable	QRC-HT-19-DF-49/CN-W3
1.90	1.95	8.07		
59,5	54	205	Carbon Steel with Steel cable	QRC-HT-25-DF-49/CN-W3
2.34	2.13	8.07		

Dimensions (mm/in)			Material	Dust Cap for Male Tip
D1	D2	L		Ordering Codes
49,5	45	205	Carbon Steel with Steel cable	QRC-HT-19-DM-41/CN-W3
1.95	1.95	8.07		
59,5	54	205	Carbon Steel with Steel cable	QRC-HT-25-DM-49/CN-W3
2.34	2.13	8.07		

Note: The connection of the two halves of a coupling is achieved depending on the type. It is important to observe the positive engagement of plug-type couplings and the secure tightening of screw-type couplings to the limit stop of the thread. Forced or improper separation will result in malfunction of the coupling.



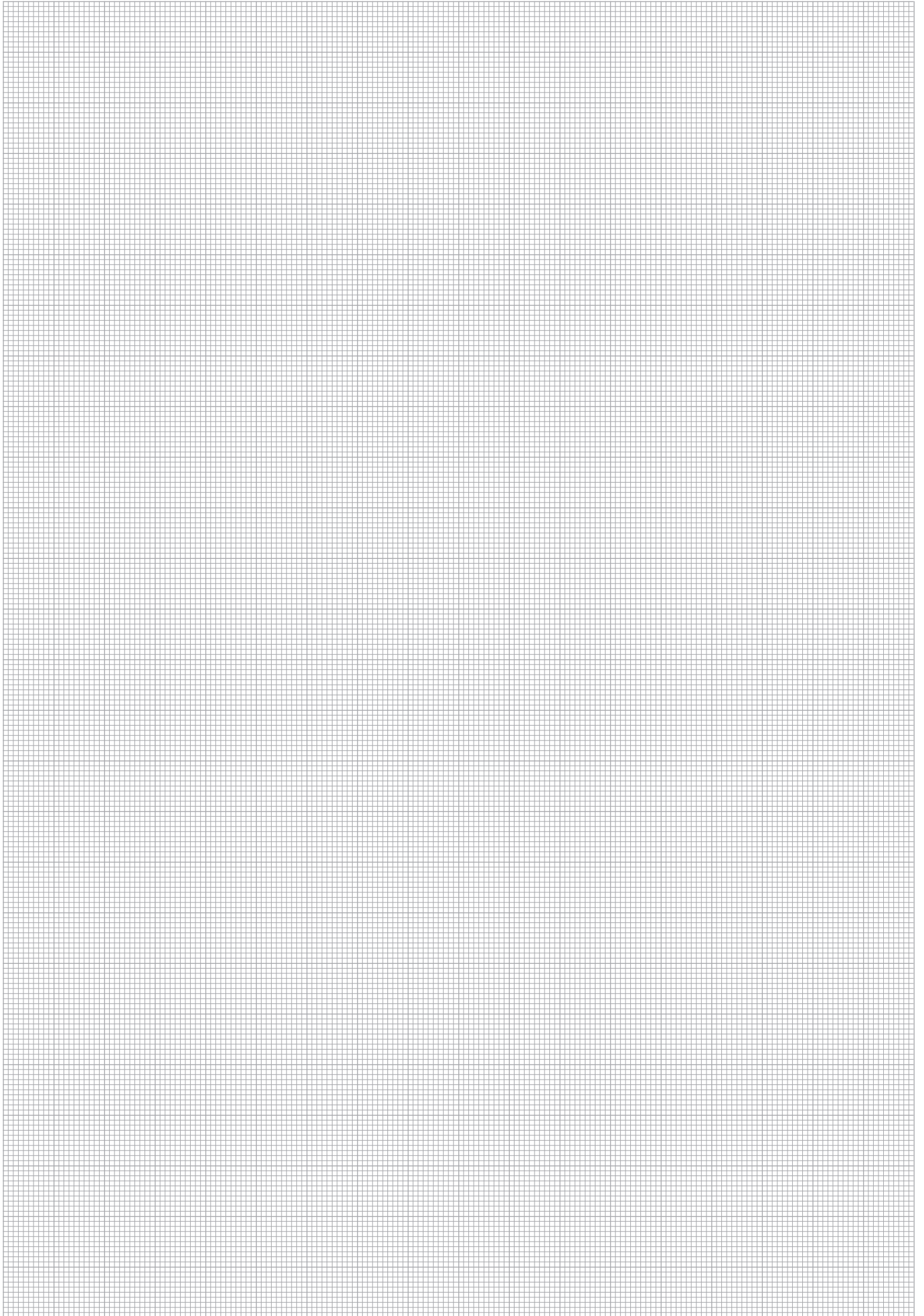

HT



**Series HM • Carbon Steel and Brass**

Series HM • Overview	174
Series HM-19 • BG 4 • Nominal Size 19	175
Series HM-25 • BG 6 • Nominal Size 25	175
Series HM-31 • BG 8 • Nominal Size 31,5	175
Series HM-38 • BG 10 • Nominal Size 38	175
Series HM • Dust Protection	176

**HM**

**Series HM - Carbon Steel and Brass**

Material	Brass and Carbon Steel
Surface Finishing	Carbon Steel: Zinc-Plating and Thick-Film-Passivation (Chrome III)
Standard Seal Material(s)	NBR (Buna-N®) <sup>2</sup>
Working Temperature	-25° C ... +100° C / -13° F ... +212° F
Valve Design	Flat Valve
Connection	Screw
Disconnection	Screw
Connect Under Pressure	not allowed
Application	Industrial Hydraulic
ISO Interchange	-



Male Tip

Female Body

<sup>2</sup>Alternative seal materials are available on request.

**Technical Data**

Series	BG	DN Zoll	DN metric ISO 4397	Q <sub>max</sub>		Working Pressure		Bursting Pressure Connected		Female Body		Male Tip		Spillage	
				l/min	US GPM	bar	PSI	bar	PSI	bar	PSI	bar	PSI	ml	fl oz
HM-19	4	3/4"	19 (20)	220	58.12	210	3046	1160	16824	580	8412	460	6672	0,15	.0051
HM-25	6	1"	25	260	68.68	210	3046	880	12763	720	10443	370	5366	0,4	.0135
HM-31	8	1 1/4"	31	400	105.67	190	2756	520	7542	570	8267	430	6237	0,65	.0220
HM-38	10	1 1/2"	38	600	158.50	170	2466	500	7252	350	5076	430	6237	0,85	.0287

The indicated pressure ratings only apply to the coupling itself and depend on the connection type.

**Flow Characteristics**

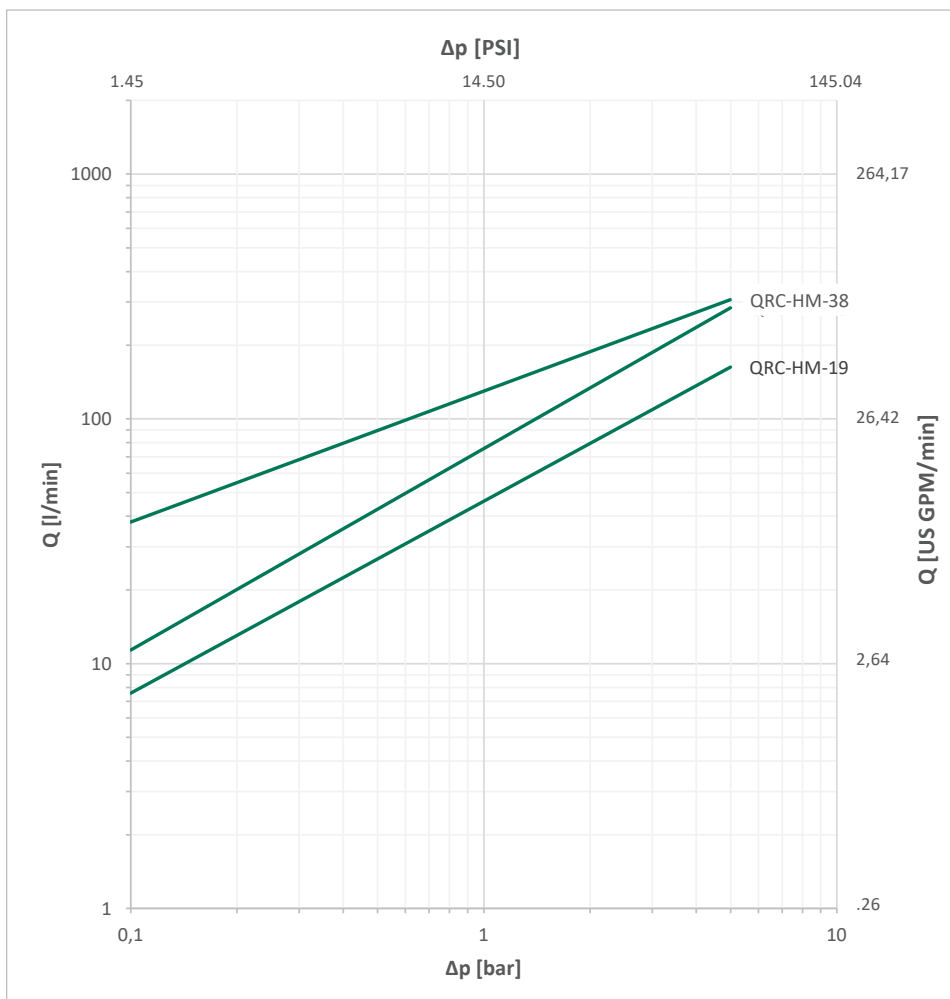

Please note: Unless otherwise stated, all flow characteristics have been determined with hydraulic oil with a kinematic viscosity of 28,8 - 35,2 mm<sup>2</sup>/s (28,8 - 35,2 cSt) and are only valid for components with non-reducing connections.

HM



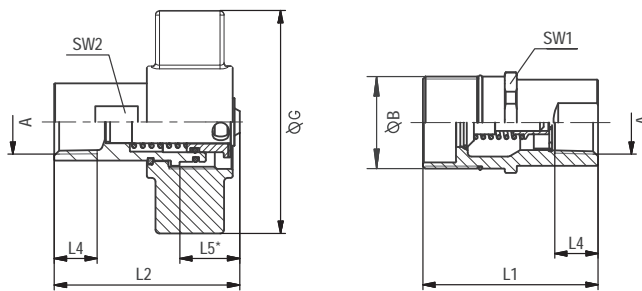

SW: Width across flats. All dimensions in mm (inch). Drawing similar Series HM-25.  
\* Insertion Male Tip.

### Series HM-19 • BG 4 • Nominal Size 19

Port A	Dimensions ( <sup>mm/in</sup> )								Female Body Ordering Codes	Weight ( <sup>kg/lbs</sup> ) ca. per 100	Male Tip Ordering Codes	Weight ( <sup>kg/lbs</sup> ) ca. per 100
	ØB	ØG	L1	L2	L4 min	L5	SW1	SW2				
Female Thread according to ANSI B 1.20.3												
	NPTF 1/2" -14	1"1/2 - 12UNF	102 4.01	79 3.11	80,5 3.17		41,3 1"5/8	28,6 1"1/8	QRC-HM-19-F-NF08-BT-W162	63,50 139.99	QRC-HM-19-M-NF08-B-W162	43 94.80
	NPTF 3/4" -14	1"1/2 - 12UNF	102 4.01	79 3.11	80,5 3.17		41,3 1"5/8	28,6 1"1/8	QRC-HM-19-F-NF12-BT-W162	60,20 132.72	QRC-HM-19-M-NF12-B-W162	39,50 87.08

### Series HM-25 • BG 6 • Nominal Size 25

Port A	Dimensions ( <sup>mm/in</sup> )								Female Body Ordering Codes	Weight ( <sup>kg/lbs</sup> ) ca. per 100	Male Tip Ordering Codes	Weight ( <sup>kg/lbs</sup> ) ca. per 100
	ØB	ØG	L1	L2	L4 min	L5	SW1	SW2				
Female Thread according to ANSI B 1.20.3												
	NPTF 1" -11 1/2	1"7/8 - 12UN	114,5 4.50	90 3.54	95,3 3.75		48 1"7/8	36,3 1"7/16	QRC-HM-25-F-NF16-BT-W162	104 229.28	QRC-HM-25-M-NF16-B-W162	63,30 139.55

### Series HM-31 • BG 8 • Nominal Size 31,5

Port A	Dimensions ( <sup>mm/in</sup> )								Female Body Ordering Codes	Weight ( <sup>kg/lbs</sup> ) ca. per 100	Male Tip Ordering Codes	Weight ( <sup>kg/lbs</sup> ) ca. per 100
	ØB	ØG	L1	L2	L4 min	L5	SW1	SW2				
Female Thread according to ANSI B 1.20.3												
	NPTF 1 1/4" -11 1/2	2"1/8 - 12UN	135 4.31	94,2 3.71	100 3.94		55,1 2"3/18	44,5 1"3/4	QRC-HM-31-F-NF20-BT-W162	125,50 276.68	QRC-HM-31-M-NF20-B-W162	76,50 168.65

### Series HM-38 • BG 10 • Nominal Size 38

Port A	Dimensions ( <sup>mm/in</sup> )								Female Body Ordering Codes	Weight ( <sup>kg/lbs</sup> ) ca. per 100	Male Tip Ordering Codes	Weight ( <sup>kg/lbs</sup> ) ca. per 100
	ØB	ØG	L1	L2	L4 min	L5	SW1	SW2				
Female Thread according to ANSI B 1.20.3												
	NPTF 1 1/2" -11 1/2	2"1/2 - 12UN	135 5.31	104,5 4.11	103 4.06		63,5 2"1/2	50,8 2"	QRC-HM-38-F-NF24-BT-W162	155 341.72	QRC-HM-38-M-NF24-B-W162	116 255.74

**HM**

Note: The connection of the two halves of a coupling is achieved depending on the type. It is important to observe the positive engagement of plug-type couplings and the secure tightening of screw-type couplings to the limit stop of the thread. Forced or improper separation will result in malfunction of the coupling.



Series HM • Dust Protection

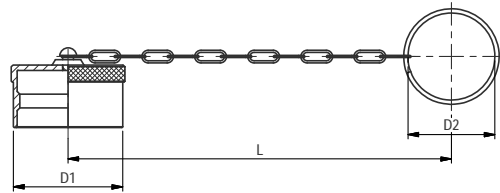
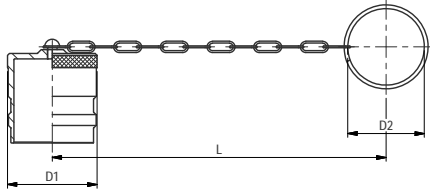

Dimensions (mm/in)			Material	Dust Plug for Female Body
D1	D2	L		Ordering Codes
40	30	210	Brass with chain	QRC-HM-19-DF-30/CN-W69
1.57	1.18	8.27		
48,0	41	270	Brass with chain	QRC-HM-25-DF-41/CN-W69
1.89	1.61	10.63		
56	48	280	Brass with chain	QRC-HM-31-DF-48/CN-W69
2.20	1.89	11.02		
63	48	280	Brass with chain	QRC-HM-38-DF-48/CN-W69
2.48	1.89	11.02		

Dimensions (mm/in)			Material	Dust Cap for Male Tip
D1	D2	L		Ordering Codes
41	30	210	Brass with chain	QRC-HM-19-DM-30/CN-W69
1.61	1.18	8.27		
53	41	270	Brass with chain	QRC-HM-25-DM-41/CN-W69
2.09	1.61	10.63		
62	48	280	Brass with chain	QRC-HM-31-DM-48/CN-W69
2.44	1.89	11.02		
69	48	280	Brass with chain	QRC-HM-38-DM-48/CN-W69
2.72	1.89	11.02		

HM





**Series HV • Carbon Steel**

Series HV • Overview	178
Series HV-19 • BG 4 • Nominal Size 19	179
Series HV-25 • BG 6 • Nominal Size 25	179
Series HV-31 • BG 8 • Nominal Size 31,5	179
Series HV-38 • BG 10 • Nominal Size 38	179
Series HV-51 • BG 12 • Nominal Size 51	180
Series HV • Dust Protection	180

**HV**

### Series HV ▪ Carbon Steel

Material	Carbon Steel
Surface Finishing	Zinc-Plating and Thick-Film-Passivation (Chrome III)
Standard Seal Material(s)	NBR (Buna-N®) <sup>2</sup>
Working Temperature	-25° C ... +100° C / -13° F ... +212° F
Valve Design	Poppet Valve
Connection	Screw
Disconnection	Screw
Connect Under Pressure	Male Tip and Female Body up to max. 100 bar / 1450 PSI allowed
Application	Industrial Hydraulic
ISO Interchange	-



<sup>2</sup>Alternative seal materials are available on request.

### Technical Data

Series	BG	DN Zoll Inch	DN metric ISO 4397	Q <sub>max</sub>		Working Pressure		Bursting Pressure Connected		Female Body		Male Tip		Spillage	
				l/min	US GPM	bar	PSI	bar	PSI	bar	PSI	bar	PSI	ml	fl oz
HV-19	4	3/4"	19 (20)	190	50.19	350	5076	1500	21756	750	10878	1400	20305	8	.2705
HV-25	6	1"	25	280	73.97	350	5076	1600	23206	900	13053	1500	21756	16	.5410
HV-31	8	1 1/4"	31	480	126.80	350	5076	1300	18855	850	12328	1600	23206	31	10.482
HV-38	10	1 1/2"	38	700	184.92	350	5076	1200	17405	600	8702	900	13053	64	21.641
HV-51	12	2"	51	1000	264.17	350	5076	1100	15954	500	7252	600	8702	141	47.678

The indicated pressure ratings only apply to the coupling itself and depend on the connection type.

### Flow Characteristics

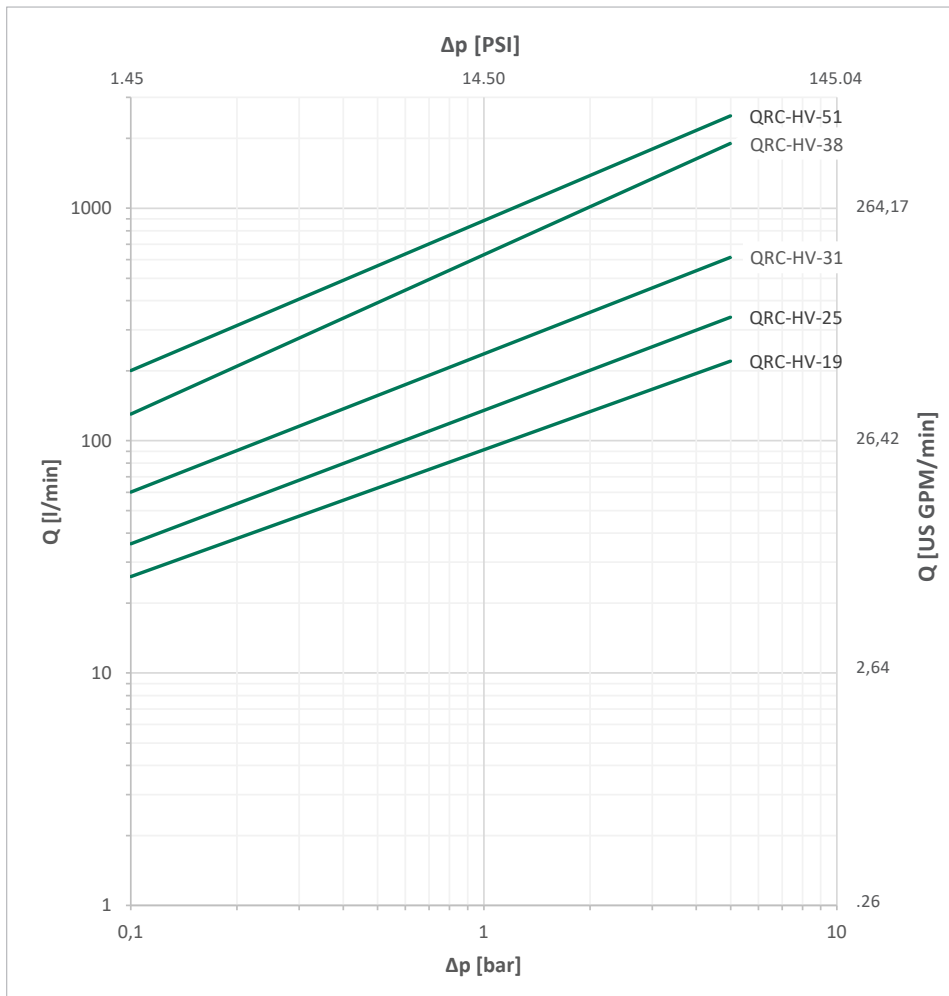

Please note: Unless otherwise stated, all flow characteristics have been determined with hydraulic oil with a kinematic viscosity of 28,8 - 35,2 mm<sup>2</sup>/s (28,8 - 35,2 cSt) and are only valid for components with non-reducing connections.



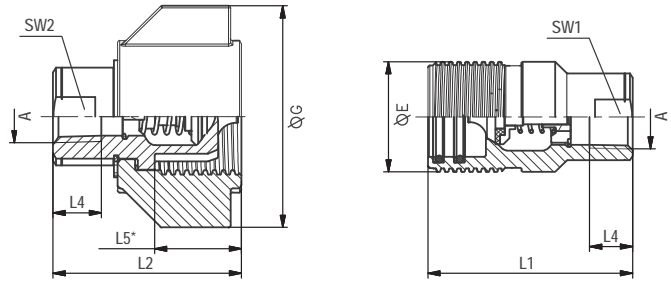

SW: Width across flats. All dimensions in mm (inch). Drawing similar Series HV-25.  
\* Insertion Male Tip.

### Series HV-19 • BG 4 • Nominal Size 19

Port A	Dimensions (mm/in)								Female Body Ordering Codes	Weight (kg/lbs) ca. per 100	Male Tip Ordering Codes	Weight (kg/lbs) ca. per 100	
	ØE	ØG	L1	L2	L4 min	L5	SW1	SW2					
Female Thread according to ANSI B 1.20.3													
	NPTF 3/4" -14	44,5	72	83	62		22	31,8	31,8	QRC-HV-19-F-NF12-BT-W66	84	QRC-HV-19-M-NF12-B-W66	48
		1.75	2.83	3.27	2.44		0.87	1"1/4	1"1/4		185.19		105.82

### Series HV-25 • BG 6 • Nominal Size 25

Port A	Dimensions (mm/in)								Female Body Ordering Codes	Weight (kg/lbs) ca. per 100	Male Tip Ordering Codes	Weight (kg/lbs) ca. per 100	
	ØE	ØG	L1	L2	L4 min	L5	SW1	SW2					
Female Thread according to ANSI B 1.20.3													
	NPTF 1" -11 1/2	57	102	106	87,6		39,95	41,3	41,3	QRC-HV-25-F-NF16-BT-W66	114,50	QRC-HV-25-M-NF16-B-W66	110
		2.25	4.01	4.17	3.45		1.57	1"5/8	1"5/8		252.43		242.51

### Series HV-31 • BG 8 • Nominal Size 31,5

Port A	Dimensions (mm/in)								Female Body Ordering Codes	Weight (kg/lbs) ca. per 100	Male Tip Ordering Codes	Weight (kg/lbs) ca. per 100	
	ØE	ØG	L1	L2	L4 min	L5	SW1	SW2					
Female Thread according to ANSI B 1.20.3													
	NPTF 1 1/4" -11 1/2	66,5		136	113		51			QRC-HV-31-F-NF20-BT-W66	253	QRC-HV-31-M-NF20-B-W66	187
		2.62		5.35	4.45		12.01				557.77		412.26

### Series HV-38 • BG 10 • Nominal Size 38

Port A	Dimensions (mm/in)								Female Body Ordering Codes	Weight (kg/lbs) ca. per 100	Male Tip Ordering Codes	Weight (kg/lbs) ca. per 100	
	ØE	ØG	L1	L2	L4 min	L5	SW1	SW2					
Female Thread according to ANSI B 1.20.3													
	NPTF 1 1/2" -11 1/2	82,5	140	152	133,3		64,3			QRC-HV-38-F-NF24-BT-W66	401	QRC-HV-38-M-NF24-B-W66	310
		3.25	5.51	5.98	5.25		2.53				884.05		683.43

**HV**

Note: The connection of the two halves of a coupling is achieved depending on the type. It is important to observe the positive engagement of plug-type couplings and the secure tightening of screw-type couplings to the limit stop of the thread. Forced or improper separation will result in malfunction of the coupling.



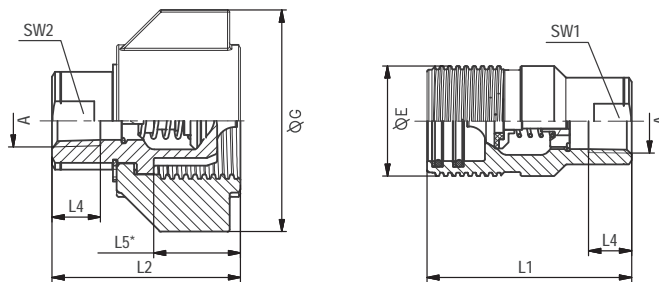

SW: Width across flats. All dimensions in mm (inch). Drawing similar Series HV-25.  
\* Insertion Male Tip.

**Series HV-51 • BG 12 • Nominal Size 51**

Port A	Dimensions (mm/in)							Female Body		Weight ( <sup>kg</sup> /lbs) ca. per 100	Male Tip		Weight ( <sup>kg</sup> /lbs) ca. per 100
	ØE	ØG	L1	L2	L4 min	L5	SW1	SW2	Ordering Codes		Ordering Codes		
Female Thread according to ANSI B 1.20.3													
	NPTF 2" -11 1/2	101	162	179	151,5		75,5		QRC-HV-51-F-NF32-BT-W66	793,50	QRC-HV-51-M-NF32-B-W66	557	
		3,97	6,37	7,05	5,96		2,97			1749,67		1227,98	

**Series HV • Dust Protection**



Dimensions (mm/in)			Material	Dust Plug for Female Body	
D1	D2	L		Ordering Codes	
			Aluminium with chain	QRC-HV-19-DF-CN-W89-SI*	
69,5	48	270	Aluminium with chain	QRC-HV-25-DF-48/CN-W89-SI	
2,74	1,89	10,63	Aluminium with chain	QRC-HV-31-DF-49/CN-W89-SI	
75,5	49	270	Aluminium with chain	QRC-HV-31-DF-49/CN-W89-SI	
2,97	1,93	10,63	Aluminium with chain	QRC-HV-38-DF-48/CN-W89-SI	
95,5	48	280	Aluminium with chain	QRC-HV-38-DF-48/CN-W89-SI	
3,76	1,89	11,02	Aluminium with chain	QRC-HV-51-DF-CN-W89-SI*	

Dimensions (mm/in)			Material	Dust Cap for Male Tip	
D1	D2	L		Ordering Codes	
			Aluminium with chain	QRC-HV-19-DM-CN-W89-SI*	
70	48	270	Aluminium with chain	QRC-HV-25-DM-48/CN-W89-SI	
2,76	1,89	10,63	Aluminium with chain	QRC-HV-31-DM-49/CN-W89-SI	
80,5	49	270	Aluminium with chain	QRC-HV-31-DM-49/CN-W89-SI	
3,17	1,93	10,63	Aluminium with chain	QRC-HV-38-DM-48/CN-W89-SI	
96	48	280	Aluminium with chain	QRC-HV-38-DM-48/CN-W89-SI	
3,78	1,89	11,02	Aluminium with chain	QRC-HV-51-DM-CN-W89-SI*	

\* Available on request.



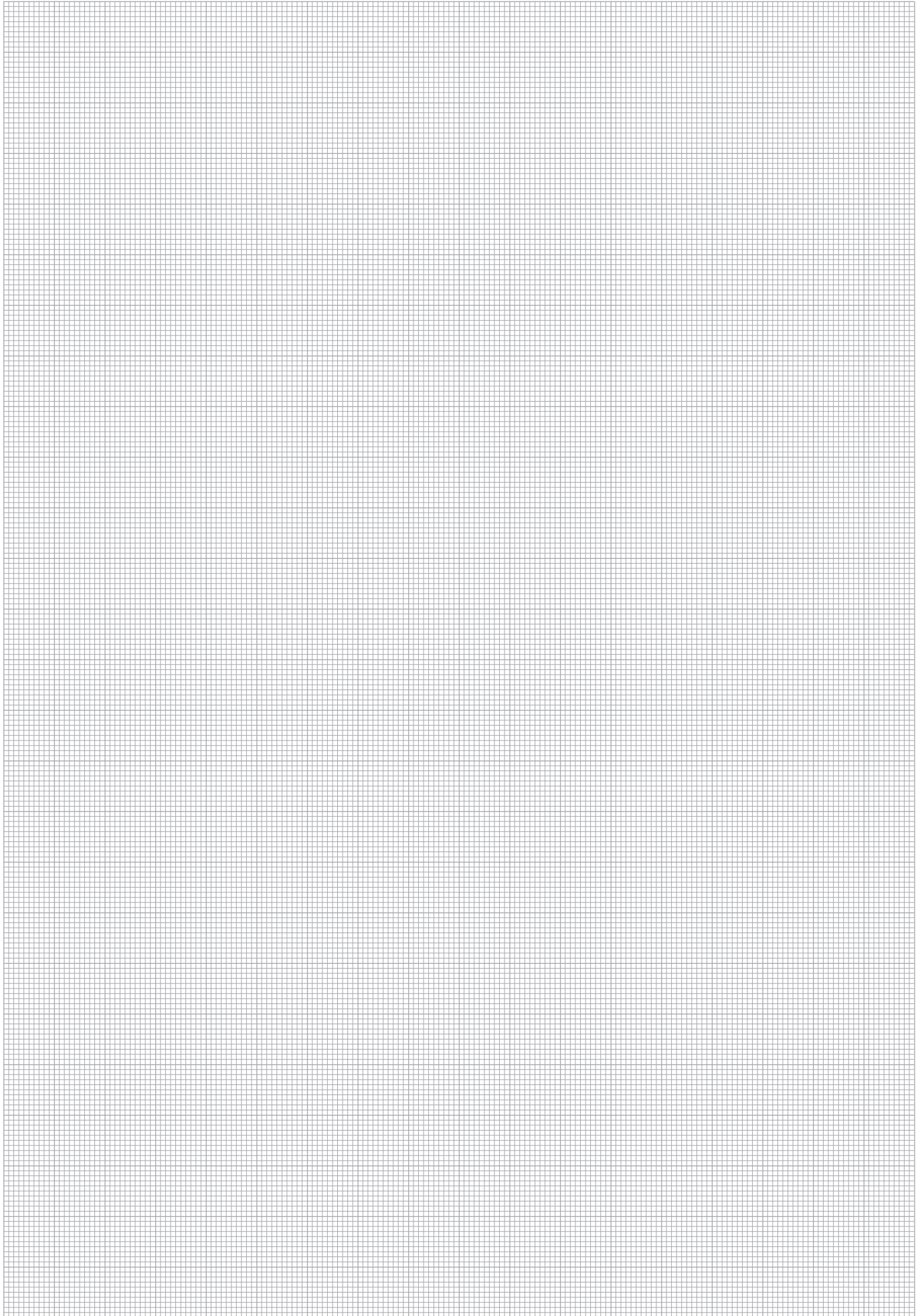

HV







In addition of our common couplings series, we also have various special designs for a huge range of special applications, even outside the hydraulic area, in our portfolio.

We are open minded to find customized solutions for all kind of applications and different influencing factors and work them out for or together with our customers.

## Water Application



## Electro-technics

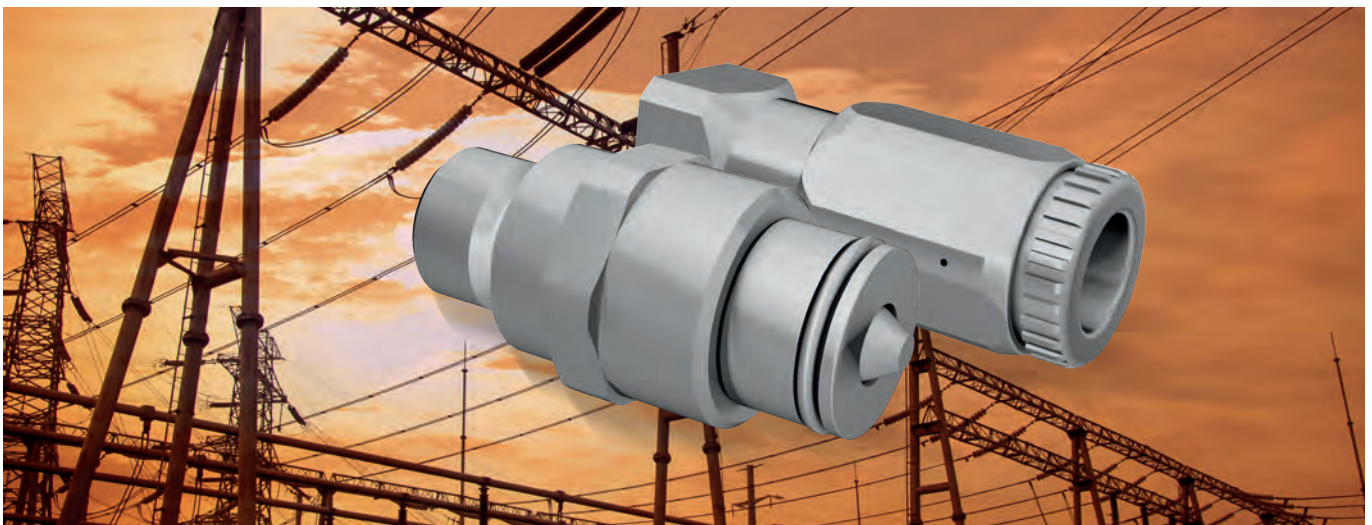

Note: The connection of the two halves of a coupling is achieved depending on the type. It is important to observe the positive engagement of plug-type couplings and the secure tightening of screw-type couplings to the limit stop of the thread. Forced or improper separation will result in malfunction of the coupling.





### Automotive Engineering



### Agricultural Engineering



### Refrigeration



Note: The connection of the two halves of a coupling is achieved depending on the type. It is important to observe the positive engagement of plug-type couplings and the secure tightening of screw-type couplings to the limit stop of the thread. Forced or improper separation will result in malfunction of the coupling.



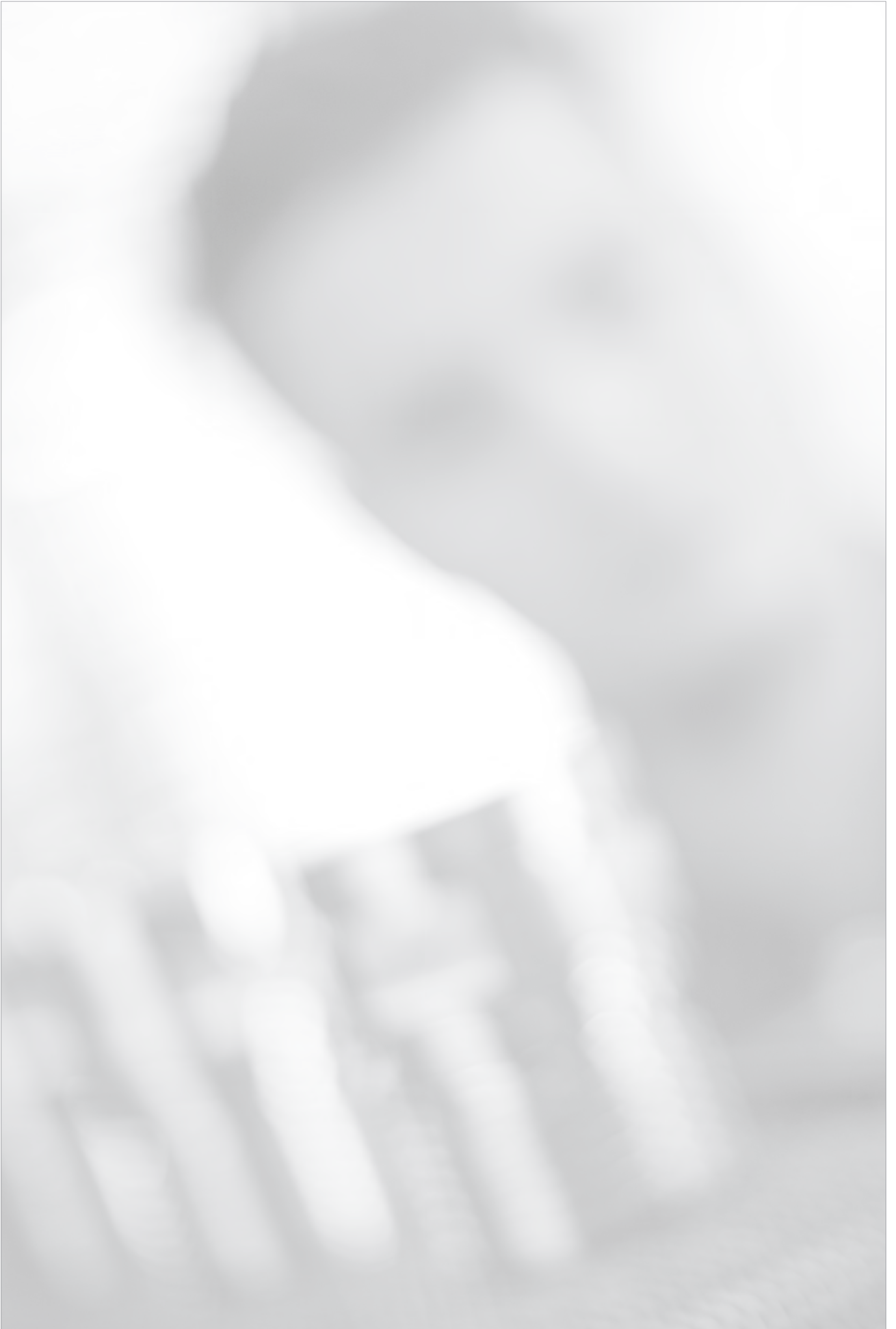

Dust cover clips	188
Dust cover body	188
Marking Clips	189
Safety Clamp with 4-hole flange	189
Anchor bracket for Male Tip	189
Seal Kits	190 - 191

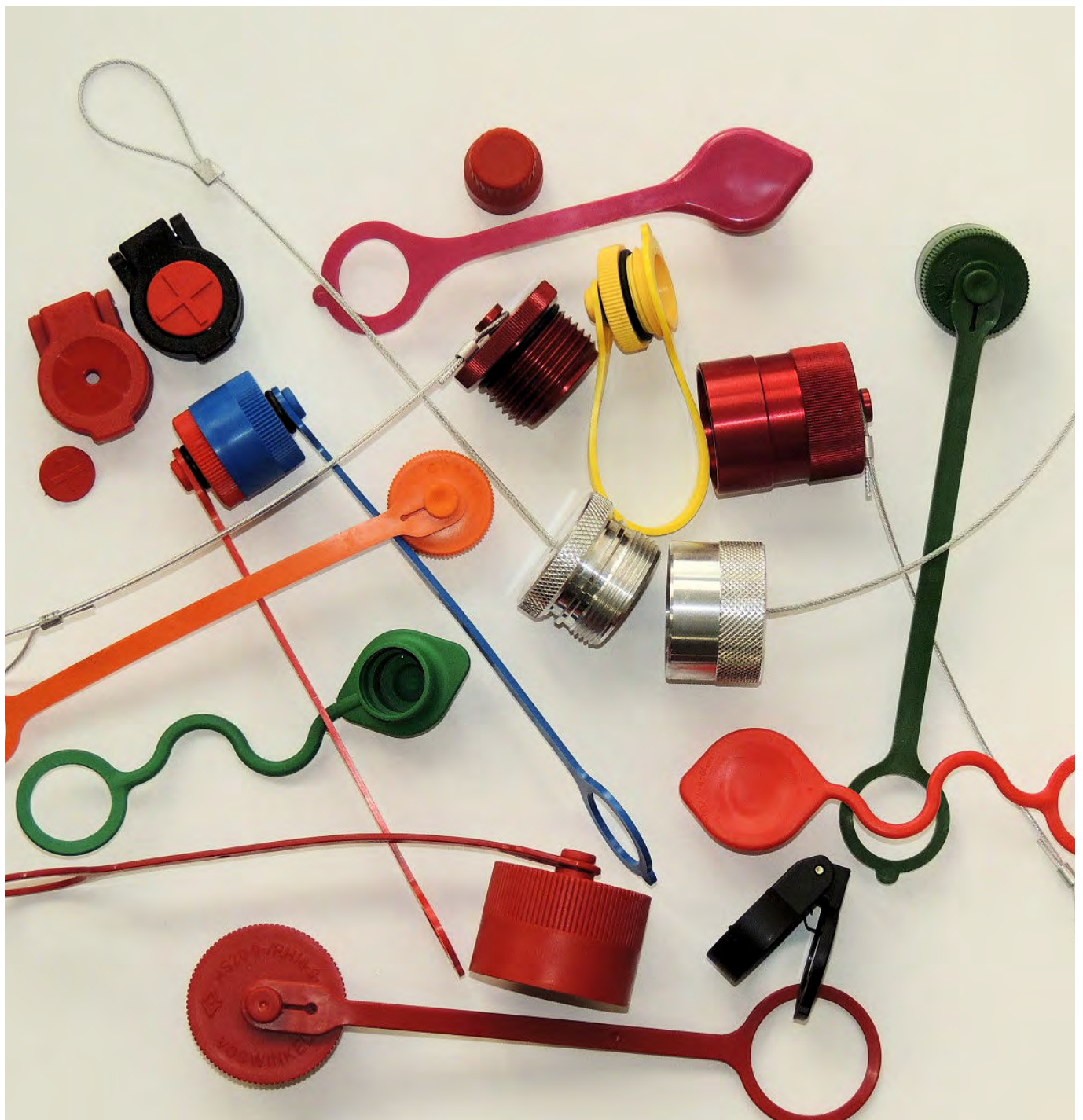

## Dust cover clips

### Description

This dust guard can be fitted to the Female Body after installation for the Series HP and FF. The cap is also available with an optional drill hole for a marking clip.

In addition to the standard colour black, plastic dust caps are also available for the types HP-10 and the series FF in blue, green, yellow and red. Please use the old color codes BL, GN, GE and RT respectively instead of SW. Please use the STAUFF codes BU, GN, YE and RD respectively instead of BK. The types HP-08 and HP-12 are only available in black.

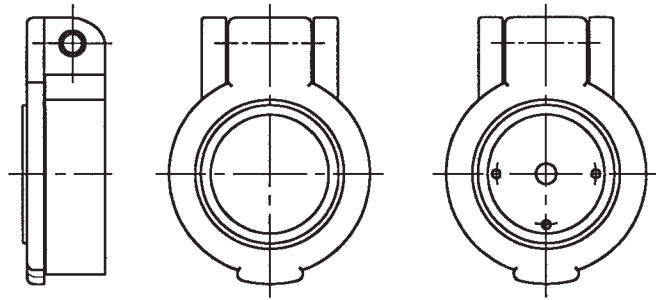

Type	Without bore	With bore
	Ordering Codes	Ordering Codes
HP-10 + FF-10		QRC-SZ-SF-32/L-K-BK
UX-12/HP-12 + FF-12	QRC-SZ-SF-38-K-BK	QRC-SZ-SF-38/L-K-BK
HP-19 + FF-19		QRC-SZ-SF-46/L-K-BK

## Dust cover body

### Description

The dust guard is used to protect the carrier half against pollution. The cap is also available with an optional drill hole for a marking clip.

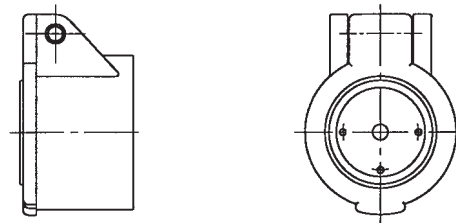

Type	Without bore	With bore
	Ordering Codes	Ordering Codes
RH-10	QRC-RH-10-BF-30-K-BK	QRC-RH-10-BF-30/L-K-BK



## Marking Clips

**Description**

The marking clips are used for identification purposes.



Mark	Colour	Ordering Codes
1	red	QRC-SZ-CL-1-K-RD
2	red	QRC-SZ-CL-2-K-RD
3	green	QRC-SZ-CL-3-K-GN
4	green	QRC-SZ-CL-4-K-GN
5	yellow	QRC-SZ-CL-5-K-YE
6	yellow	QRC-SZ-CL-6-K-YE
7	blue	QRC-SZ-CL-7-K-BU
8	blue	QRC-SZ-CL-8-K-BU
II	white	QRC-SZ-CL-R2-K-WH
III	white	QRC-SZ-CL-R3-K-WH
Rüchl.	black	QRC-SZ-CL-T-K-BK
Neutr.	black	QRC-SZ-CL-K-BK

**Safety Clamp with 4-hole flange**
**Description**

This safety clamp enables the HP-10 Female Body to be rigidly secured on the vehicle. The carrier is held in the clamp by a spring.

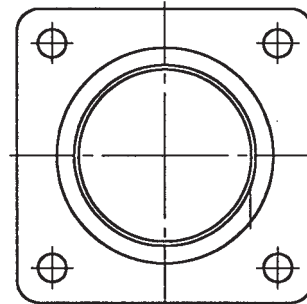
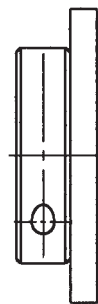
**Ordering Codes**

QRC-SZ-BH-38-W66

**Anchor bracket for Male Tip**
**Description**

The anchor bracket allows the Male Tip to be parked when disconnected. This protects the probe from damage and dirt. The anchor bracket is made of red plastic and fitted with a spring-loaded cap.

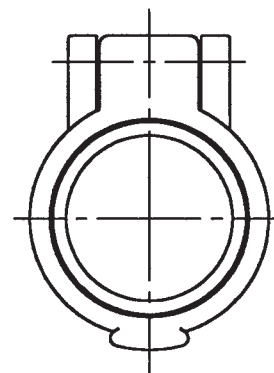
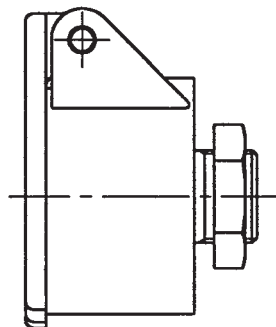
**Ordering Codes**

QRC-HP-12-MH-M18-K-RD



## Seal Kits

Type	Description	Amount	Ordering Codes
for Female Body			
HP-06	O-ring Back up ring	25	QRC-HPA-06-FSK-BT
HP-10	O-ring Back up ring	25	QRC-HP-10-FSK-BT
HP-10A	O-ring Back up ring	20	QRC-HPA-10-FSK-BT
HP-12	O-ring	50	QRC-HP-12-FSK-B
HP-19	O-ring Back up ring	25	QRC-HP-19-FSK-BT
HP-25	O-ring	25	QRC-HP-25-FSK-BT
for Male Tip			
FH-06	Profile packing	25	QRC-FH-06-MSK-PU
FH-10	O-ring Profile packing	25	QRC-FH-10-MSK-BT
FH-12	O-ring Profile packing	25	QRC-FH-12-MSK-BT
FH-16	Profile packing	25	QRC-FH-16-MSK-PU
FH-19	O-ring Profile packing	25	QRC-FH-19-MSK-BT
FH-25	O-ring PTFE ring	10	QRC-FH-25-MSK-BT
for Male Tip			
FF-06	Profile packing	25	QRC-FF-06-MSK-PU
FF-10	Profile packing	25	QRC-FF-10-MSK-PU
FF-12	Profile packing	25	QRC-FF-12-MSK-PU
FF-16	Profile packing	25	QRC-FF-16-MSK-PU
FF-19	Profile packing	25	QRC-FF-19-MSK-PU
FF-25	O-ring PTFE ring	10	QRC-FF-25-MSK-BT
for Female Body			
HS-06	O-ring Back up ring Arrest ring	25	QRC-HS-06-FSK-BT
HS-10	O-ring Back up ring Arrest ring	25	QRC-HS-10-FSK-BT
HS-12	O-ring Back up ring Arrest ring	50	QRC-HS-12-FSK-BT
HS-19	O-ring Back up ring Arrest ring	25	QRC-HS-19-FSK-BT
HS-25	O-ring Back up ring Arrest ring	25	QRC-HS-25-FSK-BT
HS-38	O-ring Back up ring Arrest ring	10	QRC-HS-38-FSK-BT
for Female Body			
PS-25	Back up ring O-ring O-ring	5	QRC-PS-25-FSK-S4

**Note:** Any disconnection of the coupling leads up to the expiration of the guarantee.



## Seal Kits

Type	Description	Amount	Ordering Codes
for Male Tip			
FT-10	O-ring	10	QRC-FT-10-MSK-BT
	Profile packing		
FT-12	O-ring	10	QRC-FT-12-MSK-BT
	Profile packing		
FT-16	O-ring	10	QRC-FT-16-MSK-BT
	Profile packing		
FT-19	O-ring	10	QRC-FT-19-MSK-BT
	Profile packing		
FT-31	O-ring	10	QRC-FT-31-MSK-BT
	Profile packing		
for Female Body			
RH-10	O-ring	25	QRC-RH-10-FSK-BT
	Back up ring		
RH-12	O-ring	25	QRC-RH-12-FSK-BT
	Back up ring		
RH-16	O-ring	10	QRC-RH-16-FSK-BT
	Back up ring		
RK-19	O-ring	10	QRC-RK-19-FSK-BT
	Back up ring		
RH-19	O-ring	10	QRC-RH-19-FSK-BT
	Back up ring		
RH-25	O-ring	10	QRC-RH-25-FSK-BT
	Back up ring		
for Female Body			
HI-06	O-ring	10	QRC-HI-06-FSK-BT
	Back up ring		
HI-10	O-ring	10	QRC-HI-10-FSK-BT
	Back up ring		
for Female Body			
HUS-10	Back up ring	25	QRC-HUS-10-FSK-BT
	O-ring		
HUS-12	Back up ring	25	QRC-HUS-12-FSK-BT
	O-ring		
HUS-19	Back up ring	25	QRC-HUS-19-FSK-BT
	O-ring		
HUS-25	Back up ring	25	QRC-HUS-25-FSK-BT
	O-ring		
for Female Body			
IA-06	O-ring	25	QRC-IA-06-FSK-BT
	Back up ring		
IA-10	O-ring	25	QRC-IA-10-FSK-BT
	Back up ring		
IA-12	O-ring	25	QRC-IA-12-FSK-BT
	Back up ring		
IA-19	O-ring	25	QRC-IA-19-FSK-BT
	Back up ring		
IA-25	O-ring	25	QRC-IA-25-FSK-BT
	Back up ring		
for Female Body			
IB-06	O-ring	25	QRC-IB-06-FSK-BT
	Back up ring		
IB-10	O-ring	25	QRC-IB-10-FSK-BT
	Back up ring		
IB-12	O-ring	25	QRC-IB-12-FSK-BT
	Back up ring		
IB-19	O-ring	25	QRC-IB-19-FSK-BT
	Back up ring		
for Female Body			
ID-10	O-ring	25	QRC-ID-10-FSK-BT
	Back up ring		
ID-19	O-ring	25	QRC-ID-19-FSK-BT
	Back up ring		
ID-25	O-ring	25	QRC-ID-25-FSK-BT
	Back up ring		

Note: Any disconnection of the coupling leads up to the expiration of the guarantee.









## Safety Regulations for Handling of Quick Release Couplings and Accessories

### Important !

Incorrect selection or incorrect and inexpert handling of couplings and accessories may result in property damage or personal injury.

- High velocity fluid discharge
- Explosion or combustion of the conveyed fluid
- Collision with moving or dropping components, caused by failure of a hydraulic circuit
- Dangerous whipping of hydraulic hoses
- Risk of injury through contacting hot, cold or otherwise dangerous fluids

Read and observe the following instructions prior to selecting and using a snap-in coupling or associated accessories.

### 1 General Notes

#### 1.1 General

This section contains instructions on selection and handling (installation, coupling and uncoupling and maintenance). This is to be understood as additional safety notes and must be taken into consideration in the use and application of the products.

#### 1.2 Safety Measures

Couplings may possibly fail without prior warning. Take this into consideration when planning the safety devices of your system or plant.

#### 1.3 Information for the User

Forward these safety notes to the persons responsible for the selection and handling of couplings. Use only couplings for which you have received and understood product-specific information.

### 1.4 Responsibility of the User

Due to the versatile range of applications of couplings, not every application case and every technical detail can be dealt with in this document.

The user is responsible for:

- final selection of the product
- fulfilment of requirements by the operator
- safety of operating personnel and plant
- safety measures necessary in the use of couplings

Should you have any further questions, please contact our sales department.

### 2 Correct Selection of Couplings

#### 2.1 Pressure Range

The coupling to be used must be selected so that the maximum permissible operating pressure is equal to or higher than the system pressure. Pressure peaks in the system in excess of the operating pressure reduce the service life of the couplings and therefore should be taken into consideration when making the selection.

#### 2.2 Resistance to Media

The Sealing Materials in the couplings are suitable for a large variety of pressure media. Information on the compatibility of a particular type of fluid are available upon request from product manager.

#### 2.3 Operating Temperature

The indication of operating temperatures in the technical specifications represents maximum values. These values may not be exceeded in standing or flowing circuits. For actuation the natural warming of the coupling must also be taken into consideration.

### 2.4 Size

The selection of the size and type of connection depends on the required transmission of forces. For this purpose, refer to the corresponding diagrams. Flow volume, pressure loss and flow speed should be taken into consideration when selecting the correct size of a coupling. Should these values be exceeded, malfunctions within the coupling may occur.

### 2.5 Mechanical Connection

The connection of the two halves of a coupling is achieved depending on the type. It is important to observe the positive engagement of plug-type couplings and the secure tightening of screw-type couplings to the limit stop of the thread. Forced or improper separation will result in malfunction of the coupling.

### 2.6 Thermal Stress

Excessive warming of the coupling above the recommended operating temperature, for instance due to welding or soldering, can cause the formation of dangerous gases. In addition, the protective surface finish (galvanization) will be damaged and the function of the coupling may be impaired.

### 2.7 Guidelines

Applicable specifications, standards and regulations as well as technical rules must be taken into consideration in the selection of couplings.



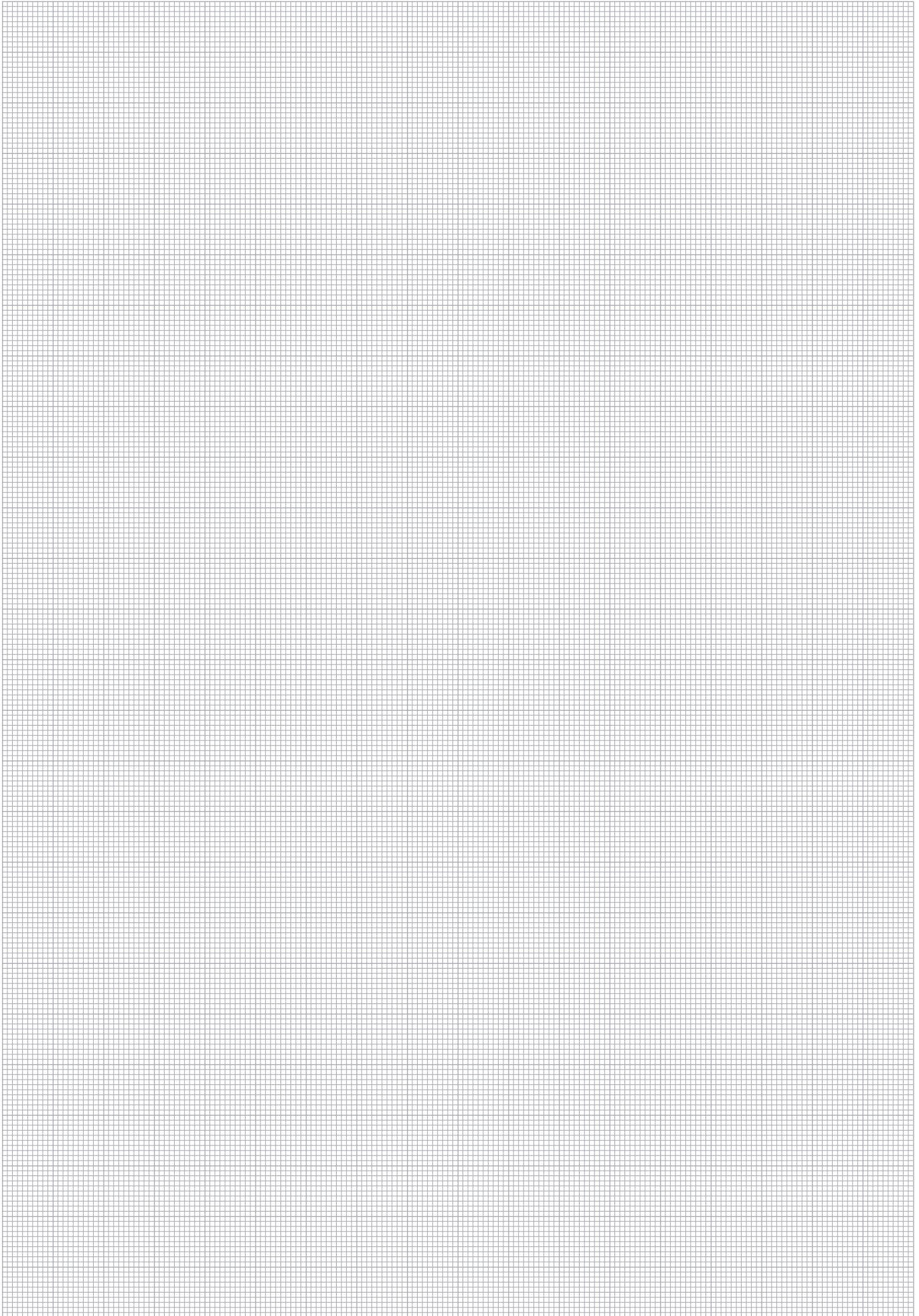



**Product-Specific Abbreviations**

198 - 201

**Global Contact Directory**

202 - 203



## Product-Specific Abbreviations

Abbreviation	Product Category	Product Description	Page
FF-06	Push-to-Connect Couplings	Series FF-06 ■ BG 1 ■ Nominal Size 6,3	23
FF-10	Push-to-Connect Couplings	Series FF-10 ■ BG 2 ■ Nominal Size 10	24
FF-12	Push-to-Connect Couplings	Series FF-12 ■ BG 3 ■ Nominal Size 12,5	25
FF-16	Push-to-Connect Couplings	Series FF-16 ■ BG 4A ■ Nominal Size 16	26
FF-19	Push-to-Connect Couplings	Series FF-19 ■ BG 4 ■ Nominal Size 19	27
FF-25	Push-to-Connect Couplings	Series FF-25 ■ BG 5 ■ Nominal Size 25	28
FF-38	Push-to-Connect Couplings	Series FF-38 ■ BG 6 ■ Nominal Size 31,5	29
FH/FU 51	Push-to-Connect Couplings	Series FH/FU 51 ■ BG 7 ■ Nominal Size 50	29
FU-10	Push-to-Connect Couplings	Series FU-10 ■ BG 2 ■ Nominal Size 10	30
FU-12	Push-to-Connect Couplings	Series FU-12 ■ BG 3 ■ Nominal Size 12,5	30
FU-19	Push-to-Connect Couplings	Series FU-19 ■ BG 4 ■ Nominal Size 19	30
FF/FH/FU ■ Dust Protection	Push-to-Connect Couplings	Series FF/FH/FU ■ Dust Protection	31
FH-10 ■ Stainless Steel	Push-to-Connect Couplings	Series FH-10 ■ BG 2 ■ Nominal Size 10	35
FH-12 ■ Stainless Steel	Push-to-Connect Couplings	Series FH-12 ■ BG 3 ■ Nominal Size 12,5	35
FH-19 ■ Stainless Steel	Push-to-Connect Couplings	Series FH-19 ■ BG 4 ■ Nominal Size 19	36
FO-06 ■ Stainless Steel	Push-to-Connect Couplings	Series FO-06 ■ BG 1 ■ Nominal Size 6,3	39
FO-10 ■ Stainless Steel	Push-to-Connect Couplings	Series FO-10 ■ BG 2 ■ Nominal Size 10	39
FO-12 ■ Stainless Steel	Push-to-Connect Couplings	Series FO-12 ■ BG 3 ■ Nominal Size 12,5	39
FO-19 ■ Stainless Steel	Push-to-Connect Couplings	Series FO-19 ■ BG 4 ■ Nominal Size 19	39
FO-25 ■ Stainless Steel	Push-to-Connect Couplings	Series FO-25 ■ BG 5 ■ Nominal Size 25	40
HP-06	Push-to-Connect Couplings	Series HP-06 ■ BG 1 ■ Nominal Size 6,3	43
HP-10	Push-to-Connect Couplings	Series HP-10 ■ BG 2 ■ Nominal Size 10	44
HP-10A	Push-to-Connect Couplings	Series HP-10A ■ BG 2 ■ Nominal Size 10	45
HP-12	Push-to-Connect Couplings	Series HP-12 ■ BG 3 ■ Nominal Size 12,5	46-47
ZP-12	Push-to-Connect Couplings	Series ZP-12 ■ BG 3 ■ Nominal Size 12,5	48
AP-12	Push-to-Connect Couplings	Series AP-12 ■ BG 3 ■ Nominal Size 12,5	49
HP-19	Push-to-Connect Couplings	Series HP-19 ■ BG 4 ■ Nominal Size 19	50
HP-25	Push-to-Connect Couplings	Series HP-25 ■ BG 6 ■ Nominal Size 25	51
HU-12	Push-to-Connect Couplings	Series HU-12 ■ BG 3 ■ Nominal Size 12,5	49
HP/HU ■ Dust Protection	Push-to-Connect Couplings	Series HP und Series HU ■ Dust Protection	52
UX-12 ■ short version	Push-to-Connect Couplings	Series UX-S-12 ■ BG 3 ■ Nominal Size 12,5 ■ short version	55
UX-12 ■ long version	Push-to-Connect Couplings	Series UX-L-12 ■ BG 3 ■ Nominal Size 12,5 ■ long version	56
IA-06	Push-to-Connect Couplings	Series IA-06 ■ BG 1 ■ Nominal Size 6,3	59
IA-10	Push-to-Connect Couplings	Series IA-10 ■ BG 2 ■ Nominal Size 10	59
IA-12	Push-to-Connect Couplings	Series IA-12 ■ BG 3 ■ Nominal Size 12,5	60
IA-19	Push-to-Connect Couplings	Series IA-19 ■ BG 4 ■ Nominal Size 19	60
IA-25	Push-to-Connect Couplings	Series IA-25 ■ BG 6 ■ Nominal Size 25	61
IA-31	Push-to-Connect Couplings	Series IA-31 ■ BG 7 ■ Nominal Size 31,5	61
IA-38	Push-to-Connect Couplings	Series IA-38 ■ BG 8 ■ Nominal Size 38	61
IA-51	Push-to-Connect Couplings	Series IA-51 ■ BG 9 ■ Nominal Size 51	61
IA ■ Dust Protection	Push-to-Connect Couplings	Series IA ■ Dust Protection	62
IA-06 ■ Stainless Steel	Push-to-Connect Couplings	Series IA-06 ■ BG 1 ■ Nominal Size 6,3	65
IA-10 ■ Stainless Steel	Push-to-Connect Couplings	Series IA-10 ■ BG 2 ■ Nominal Size 10	65
IA-12 ■ Stainless Steel	Push-to-Connect Couplings	Series IA-12 ■ BG 3 ■ Nominal Size 12,5	65
IA-19 ■ Stainless Steel	Push-to-Connect Couplings	Series IA-19 ■ BG 4 ■ Nominal Size 19	65
IA-25 ■ Stainless Steel	Push-to-Connect Couplings	Series IA-25 ■ BG 6 ■ Nominal Size 25	66
IA-31 ■ Stainless Steel	Push-to-Connect Couplings	Series IA-31 ■ BG 7 ■ Nominal Size 31,5	66
IA-38 ■ Stainless Steel	Push-to-Connect Couplings	Series IA-38 ■ BG 8 ■ Nominal Size 38	66
IA-51 ■ Stainless Steel	Push-to-Connect Couplings	Series IA-51 ■ BG 9 ■ Nominal Size 51	66
IA ■ Stainless Steel ■ Dust Protection	Push-to-Connect Couplings	Series IA ■ Dust Protection	67
IB-03	Push-to-Connect Couplings	Series IB-03 ■ BG 0 ■ Nominal Size 3,2	71
IB-06	Push-to-Connect Couplings	Series IB-06 ■ BG 1 ■ Nominal Size 6,3	71
IB-10	Push-to-Connect Couplings	Series IB-10 ■ BG 2 ■ Nominal Size 10	71
IB-12	Push-to-Connect Couplings	Series IB-12 ■ BG 3 ■ Nominal Size 12,5	72
IB-19	Push-to-Connect Couplings	Series IB-19 ■ BG 4 ■ Nominal Size 19	72
IB-25	Push-to-Connect Couplings	Series IB-25 ■ BG 6 ■ Nominal Size 25	72
IB-38	Push-to-Connect Couplings	Series IB-38 ■ BG 8 ■ Nominal Size 38	73
IB-51	Push-to-Connect Couplings	Series IB-51 ■ BG 9 ■ Nominal Size 51	73
IB ■ Dust Protection	Push-to-Connect Couplings	Series IB ■ Dust Protection	74
IB-06 ■ Brass	Push-to-Connect Couplings	Series IB-06 ■ BG 1 ■ Nominal Size 6,3	77
IB-10 ■ Brass	Push-to-Connect Couplings	Series IB-10 ■ BG 2 ■ Nominal Size 10	77
IB-12 ■ Brass	Push-to-Connect Couplings	Series IB-12 ■ BG 3 ■ Nominal Size 12,5	77
IB-19 ■ Brass	Push-to-Connect Couplings	Series IB-19 ■ BG 4 ■ Nominal Size 19	77
IB-25 ■ Brass	Push-to-Connect Couplings	Series IB-25 ■ BG 6 ■ Nominal Size 25	78
IB-38 ■ Brass	Push-to-Connect Couplings	Series IB-38 ■ BG 8 ■ Nominal Size 38	78
IB-51 ■ Brass	Push-to-Connect Couplings	Series IB-51 ■ BG 9 ■ Nominal Size 51	78
IB ■ Brass ■ Dust Protection	Push-to-Connect Couplings	Series IB ■ Dust Protection	79



## Product-Specific Abbreviations

Abbreviation	Product Category	Product Description	Page
IB-06 ■ Stainless Steel	Push-to-Connect Couplings	Series IB-06 ■ BG 1 ■ Nominal Size 6,3	83
IB-10 ■ Stainless Steel	Push-to-Connect Couplings	Series IB-10 ■ BG 2 ■ Nominal Size 10	83
IB-12 ■ Stainless Steel	Push-to-Connect Couplings	Series IB-12 ■ BG 3 ■ Nominal Size 12,5	83
IB-19 ■ Stainless Steel	Push-to-Connect Couplings	Series IB-19 ■ BG 4 ■ Nominal Size 19	83
IB-25 ■ Stainless Steel	Push-to-Connect Couplings	Series IB-25 ■ BG 6 ■ Nominal Size 25	84
IB-38 ■ Stainless Steel	Push-to-Connect Couplings	Series IB-38 ■ BG 8 ■ Nominal Size 38	84
IB-51 ■ Stainless Steel	Push-to-Connect Couplings	Series IB-51 ■ BG 9 ■ Nominal Size 51	84
IB ■ Stainless Steel ■ Dust Protection	Push-to-Connect Couplings	Series IB ■ Dust Protection	85
ID-06	Push-to-Connect Couplings	Series ID-06 ■ BG 1 ■ Nominal Size 6,3	89
ID-10	Push-to-Connect Couplings	Series ID-10 ■ BG 2 ■ Nominal Size 10	89
ID-19	Push-to-Connect Couplings	Series ID-19 ■ BG 4 ■ Nominal Size 19	89
ID-25	Push-to-Connect Couplings	Series ID-25 ■ BG 6 ■ Nominal Size 25	89
ID ■ Dust Protection	Push-to-Connect Couplings	Series ID ■ Dust Protection	90
BP-12	Push-to-Connect Couplings	Series BP-12 ■ BG 3 ■ Nominal Size 12,5	93
BP ■ Dust Protection	Push-to-Connect Couplings	Series BP ■ Dust Protection	93
HC-06	Push-to-Connect Couplings	Series HC-06 ■ BG 1 ■ Nominal Size 6,3	97
HC ■ Dust Protection	Push-to-Connect Couplings	Series HC ■ Dust Protection	97
HD-06	Push-to-Connect Couplings	Series HD-06 ■ BG 1 ■ Nominal Size 6,3	101
HD ■ Dust Protection	Push-to-Connect Couplings	Series HD ■ Dust Protection	101
HUS-10	Push-to-Connect Couplings	Series HUS-10 ■ BG 2 ■ Nominal Size 10	105
HUS-12	Push-to-Connect Couplings	Series HUS-12 ■ BG 3 ■ Nominal Size 12	105
HUS-19	Push-to-Connect Couplings	Series HUS-19 ■ BG 4 ■ Nominal Size 19	105
HUS-25	Push-to-Connect Couplings	Series HUS-25 ■ BG 6 ■ Nominal Size 25	105
HUS ■ Dust Protection	Push-to-Connect Couplings	Series HUS ■ Dust Protection	105
MK-Q-10/4	Multi Couplings	Series MK-Q-10/4 ■ BG 2 ■ Nominal Size 10	109
MK-R-10/4	Multi Couplings	Series MK-R-10/4 ■ BG 2 ■ Nominal Size 10	110
HS-06	Screw-to-Connect Couplings	Series HS-06 ■ BG 1 ■ Nominal Size 6,3	115
HS-10	Screw-to-Connect Couplings	Series HS-10 ■ BG 2 ■ Nominal Size 10	116
HS-12	Screw-to-Connect Couplings	Series HS-12 ■ BG 3 ■ Nominal Size 12,5	117-118
HS-19	Screw-to-Connect Couplings	Series HS-19 ■ BG 4 ■ Nominal Size 19	119
HS-25	Screw-to-Connect Couplings	Series HS-25 ■ BG 6 ■ Nominal Size 25	120-121
HS-38	Screw-to-Connect Couplings	Series HS-38 ■ BG 8 ■ Nominal Size 38	122
HS ■ Dust Protection	Screw-to-Connect Couplings	Series HS ■ Dust Protection	123
HS-06 ■ Stainless Steel	Screw-to-Connect Couplings	Series HS-06 ■ BG 1 ■ Nominal Size 6,3	127
HS-10 ■ Stainless Steel	Screw-to-Connect Couplings	Series HS-10 ■ BG 2 ■ Nominal Size 10	127
HS-12 ■ Stainless Steel	Screw-to-Connect Couplings	Series HS-12 ■ BG 3 ■ Nominal Size 12,5	127
HS-19 ■ Stainless Steel	Screw-to-Connect Couplings	Series HS-19 ■ BG 4 ■ Nominal Size 19	127
HS-25 ■ Stainless Steel	Screw-to-Connect Couplings	Series HS-25 ■ BG 6 ■ Nominal Size 25	128
HS-38 ■ Stainless Steel	Screw-to-Connect Couplings	Series HS-38 ■ BG 8 ■ Nominal Size 38	128
HS ■ Stainless Steel ■ Dust Protection	Screw-to-Connect Couplings	Series HS ■ Dust Protection	129
PS-25	Screw-to-Connect Couplings	Series PS-25 ■ BG 08 ■ Nominal Size 25	133
PS ■ Dust Protection	Screw-to-Connect Couplings	Series PS ■ Dust Protection	133
RH-10	Screw-to-Connect Couplings	Series RH-10 ■ BG 2 ■ Nominal Size 10	137
RH-12	Screw-to-Connect Couplings	Series RH-12 ■ BG 3 ■ Nominal Size 12,5	137
RH-16	Screw-to-Connect Couplings	Series RH-16 ■ BG 4 ■ Nominal Size 16	138
RH-19	Screw-to-Connect Couplings	Series RH-19 ■ BG 6 ■ Nominal Size 19	138
RH-25	Screw-to-Connect Couplings	Series RH-25 ■ BG 8 ■ Nominal Size 25	139
RH ■ Dust Protection	Screw-to-Connect Couplings	Series RH ■ Dust Protection	139
FT-10	Screw-to-Connect Couplings	Series FT-10 ■ BG 2 ■ Nominal Size 10	143
FT-12	Screw-to-Connect Couplings	Series FT-12 ■ BG 3 ■ Nominal Size 12,5	143
FT-16	Screw-to-Connect Couplings	Series FT-16 ■ BG 4A ■ Nominal Size 16	144
FT-19	Screw-to-Connect Couplings	Series FT-19 ■ BG 4 ■ Nominal Size 19	144
FT-25	Screw-to-Connect Couplings	Series FT-25 ■ BG 5 ■ Nominal Size 25	145
FT-31	Screw-to-Connect Couplings	Series FT-31 ■ BG 6 ■ Nominal Size 31,5	145
FT ■ Dust Protection	Screw-to-Connect Couplings	Series FT ■ Dust Protection	146
HR-10	Screw-to-Connect Couplings	Series HR-10 ■ BG 2 ■ Nominal Size 10	149
HR-12	Screw-to-Connect Couplings	Series HR-12 ■ BG 3 ■ Nominal Size 12,5	149
HR-19	Screw-to-Connect Couplings	Series HR-19 ■ BG 4 ■ Nominal Size 19	149
HR-25	Screw-to-Connect Couplings	Series HR-25 ■ BG 6 ■ Nominal Size 25	149
HR-31	Screw-to-Connect Couplings	Series HR-31 ■ BG 8 ■ Nominal Size 31,5	150
HR-38	Screw-to-Connect Couplings	Series HR-38 ■ BG 10 ■ Nominal Size 38	150
HR ■ Dust Protection	Screw-to-Connect Couplings	Series HR ■ Dust Protection	151



## Product-Specific Abbreviations

Abbreviation	Product Category	Product Description	Page
HH-10	Screw-to-Connect Couplings	Series HH-10 ▪ BG 2 ▪ Nominal Size 10	155
HH-12	Screw-to-Connect Couplings	Series HH-12 ▪ BG 3 ▪ Nominal Size 12,5	155
HH-19	Screw-to-Connect Couplings	Series HH-19 ▪ BG 4 ▪ Nominal Size 19	155
HH-25	Screw-to-Connect Couplings	Series HH-25 ▪ BG 6 ▪ Nominal Size 25	155
HH-31	Screw-to-Connect Couplings	Series HH-31 ▪ BG 8 ▪ Nominal Size 31,5	156
HH-38	Screw-to-Connect Couplings	Series HH-38 ▪ BG 10 ▪ Nominal Size 38	156
HH-51	Screw-to-Connect Couplings	Series HH-51 ▪ BG 12 ▪ Nominal Size 51	156
HH ▪ Dust Protection	Screw-to-Connect Couplings	Series HH ▪ Dust Protection	157
HH-10 ▪ Stainless Steel	Screw-to-Connect Couplings	Series HH-10 ▪ BG 2 ▪ Nominal Size 10	161
HH-12 ▪ Stainless Steel	Screw-to-Connect Couplings	Series HH-12 ▪ BG 3 ▪ Nominal Size 12,5	161
HH-19 ▪ Stainless Steel	Screw-to-Connect Couplings	Series HH-19 ▪ BG 4 ▪ Nominal Size 19	161
HH-25 ▪ Stainless Steel	Screw-to-Connect Couplings	Series HH-25 ▪ BG 6 ▪ Nominal Size 25	161
HH-31 ▪ Stainless Steel	Screw-to-Connect Couplings	Series HH-31 ▪ BG 8 ▪ Nominal Size 31,5	162
HH-38 ▪ Stainless Steel	Screw-to-Connect Couplings	Series HH-38 ▪ BG 10 ▪ Nominal Size 38	162
HH-51 ▪ Stainless Steel	Screw-to-Connect Couplings	Series HH-51 ▪ BG 12 ▪ Nominal Size 51	162
HH ▪ Stainless Steel ▪ Dust Protection	Screw-to-Connect Couplings	Series HH ▪ Dust Protection	163
HI-06	Screw-to-Connect Couplings	Series HI-06 ▪ BG 1 ▪ Nominal Size 6,3	167
HI-10	Screw-to-Connect Couplings	Series HI-10 ▪ BG 2 ▪ Nominal Size 10	167
HT-19	Screw-to-Connect Couplings	Series HT-19 ▪ BG 4 ▪ Nominal Size 19	171
HT-25	Screw-to-Connect Couplings	Series HT-25 ▪ BG 6 ▪ Nominal Size 25	171
HT ▪ Dust Protection	Screw-to-Connect Couplings	Series HT ▪ Dust Protection	171
HM-19	Screw-to-Connect Couplings	Series HM-19 ▪ BG 4 ▪ Nominal Size 19	175
HM-25	Screw-to-Connect Couplings	Series HM-25 ▪ BG 6 ▪ Nominal Size 25	175
HM-31	Screw-to-Connect Couplings	Series HM-31 ▪ BG 8 ▪ Nominal Size 31,5	175
HM-38	Screw-to-Connect Couplings	Series HM-38 ▪ BG 10 ▪ Nominal Size 38	175
HM ▪ Dust Protection	Screw-to-Connect Couplings	Series HM ▪ Dust Protection	176
HV-19	Screw-to-Connect Couplings	Series HV-19 ▪ BG 4 ▪ Nominal Size 19	179
HV-25	Screw-to-Connect Couplings	Series HV-25 ▪ BG 6 ▪ Nominal Size 25	179
HV-31	Screw-to-Connect Couplings	Series HV-31 ▪ BG 8 ▪ Nominal Size 31,5	179
HV-38	Screw-to-Connect Couplings	Series HV-38 ▪ BG 10 ▪ Nominal Size 38	179
HV-51	Screw-to-Connect Couplings	Series HV-51 ▪ BG 12 ▪ Nominal Size 51	180
HV ▪ Dust Protection	Screw-to-Connect Couplings	Series HV ▪ Dust Protection	180





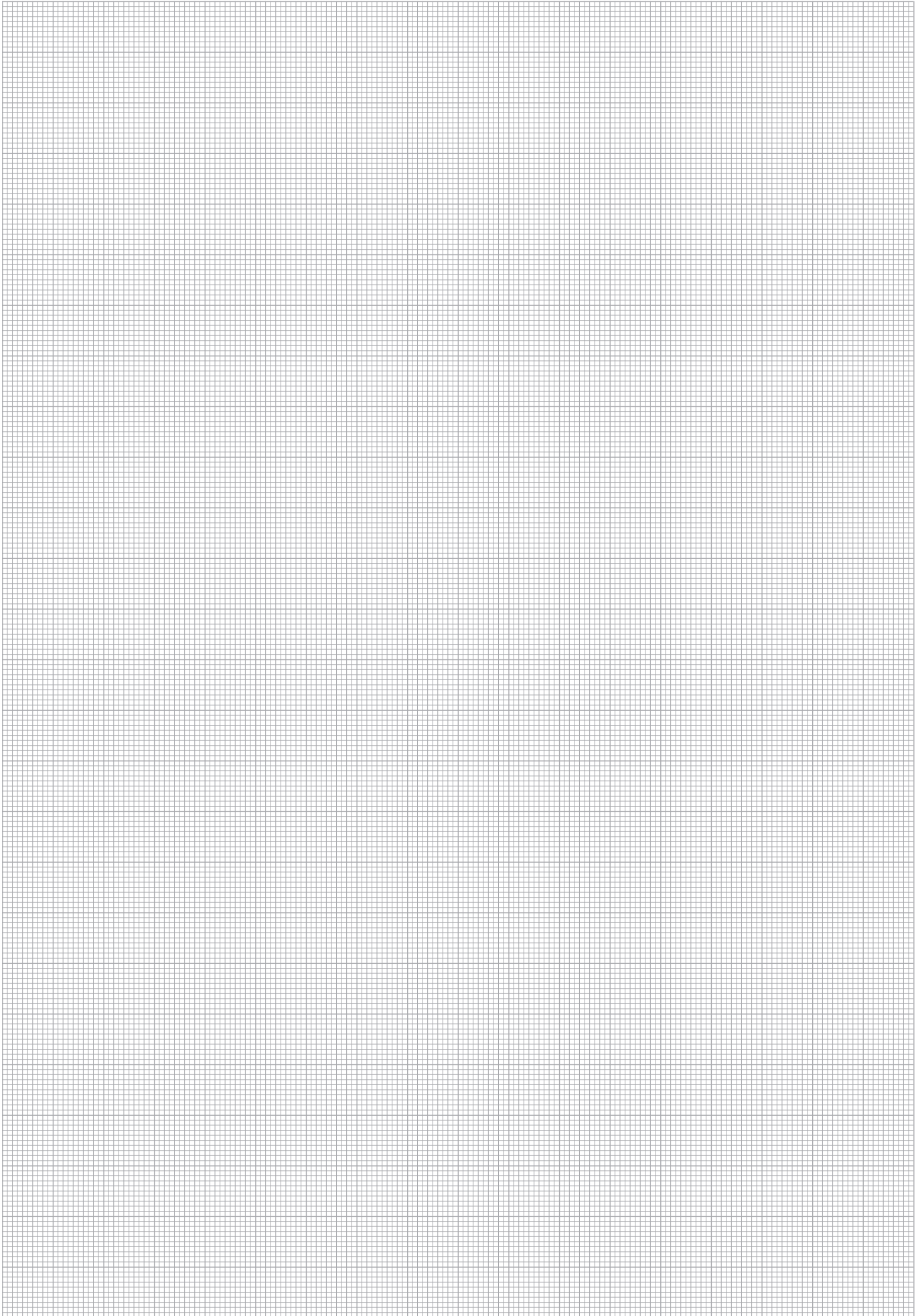

## Global Contact Directory

STAUFF products and services are globally available through wholly-owned subsidiaries and a tight network of authorised distributors and representatives in all major industrial regions of the world.

Contact information on this page may be subject to changes and additions over time. Frequently updated and complete contact information can always be found at [www.stauff.com](http://www.stauff.com).

### Germany



**Walter Stauffenberg GmbH & Co. KG**  
Im Ehrenfeld 4  
58791 Werdohl  
Tel.: +49 2392 91 60  
E-Mail: [sales@stauff.com](mailto:sales@stauff.com)  
[www.stauff.com](http://www.stauff.com)



Neuenrade-Küntrop Logistics Centre  
Wasserburgstraße 35  
58809 Neuenrade



Plettenberg-Ohle Production Site  
Lennestraße 2  
58840 Plettenberg



Meinerzhagen Production Site  
Neugrünenthal  
58540 Meinerzhagen



Meinerzhagen Production Site  
Am Rottland 7  
58540 Meinerzhagen



STAUFF Digital  
Phoenixplatz 3  
44263 Dortmund

### Europe

#### France

**STAUFF S.A.S.**  
230, Avenue du Grain d'Or  
Z.I. de Vineuil - Blois Sud  
41354 Vineuil-cedex  
Tel.: +33 2 54 50 55 50  
Fax: +33 2 54 42 29 19  
E-Mail: [direction@stauffsa.com](mailto:direction@stauffsa.com)  
[www.stauff.fr](http://www.stauff.fr)

#### Ireland

**STAUFF UK Ltd.**  
Block B, 9 Ferguson Drive  
Knockmore Hill Industrial Estate  
Lisburn, County Antrim, BT28 2EX  
Tel.: +44 2892 60 69 00  
Fax: +44 2892 60 26 88  
E-Mail: [sales@stauffireland.com](mailto:sales@stauffireland.com)  
[www.stauff.co.uk](http://www.stauff.co.uk)

#### Italy

**STAUFF Italia s.r.l.**  
Via Borima 21 (Frazione Borima)  
23867 Suello (LC)  
Tel.: +39 031 65 84 94  
Fax: +39 031 65 50 05  
E-Mail: [sales@stauff.it](mailto:sales@stauff.it)  
[www.stauff.it](http://www.stauff.it)

#### Poland

**STAUFF Polska Sp. z o.o.**  
Miszewko 43 A  
80-297 Banino  
Tel.: +48 58 660 11 60  
Fax: +48 58 629 79 52  
E-Mail: [sales@stauff.pl](mailto:sales@stauff.pl)  
[www.stauff.pl](http://www.stauff.pl)

#### Russian Federation

**STAUFF LLC**  
Building 1  
19, Leninskaya Sloboda  
Moscow, 115280  
Tel.: +7 495 276 16 50  
Fax: +7 495 276 16 51  
E-Mail: [sales@stauff.ru](mailto:sales@stauff.ru)  
[www.stauff.ru](http://www.stauff.ru)

#### United Kingdom

**STAUFF UK Ltd.**  
500, Carlisle Street East  
Off Downgate Drive  
Sheffield, S4 8BS  
Tel.: +44 114 251 85 18  
Fax: +44 114 251 85 19  
E-Mail: [sales@stauff.co.uk](mailto:sales@stauff.co.uk)  
[www.stauff.co.uk](http://www.stauff.co.uk)

**STAUFF UK Ltd.**  
Badentoy Avenue  
Badentoy Industrial Estate  
Portlethen, Aberdeen, AB12 4YB  
Tel.: +44 1224 78 61 66  
Fax: +44 1224 78 61 77  
E-Mail: [sales@stauffscotland.co.uk](mailto:sales@stauffscotland.co.uk)  
[www.stauff.co.uk](http://www.stauff.co.uk)

**STAUFF UK Ltd.**  
Unit 9, Southampton Trade Park  
Third Avenue, Millbrook  
Southampton, SO15 0AD  
Tel.: +44 2380 69 87 00  
Fax: +44 2380 69 87 01  
E-Mail: [sales@stauffsouthampton.co.uk](mailto:sales@stauffsouthampton.co.uk)  
[www.stauff.co.uk](http://www.stauff.co.uk)

Further branch offices in  
Engels, Volzhskiy, Magnitogorsk,  
Nizhny Novgorod and St. Petersburg.



## Global Contact Directory

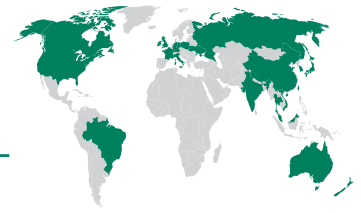

## North America

## Canada

**STAUFF Canada Ltd.**  
866 Milner Avenue  
Scarborough  
Ontario M1B 5N7  
Tel.: +1 416 282 46 08  
Fax: +1 416 282 30 39  
E-Mail: sales@stauffcanada.com  
[www.stauffcanada.com](http://www.stauffcanada.com)

## United States

**STAUFF Corporation**  
7 Wm. Demarest Place  
Waldwick, 07463-1542  
New Jersey  
Tel.: +1 201 444 78 00  
Fax: +1 201 444 78 52  
E-Mail: sales@stauffusa.com  
[www.stauffusa.com](http://www.stauffusa.com)

Further branch office in  
Canton, Michigan.

## South America

## Brazil

**STAUFF Brasil Ltda.**  
Avenida Gupê 10767  
Galpão 2 - Bloco A  
Barueri, São Paulo, CEP 06422-120  
Tel.: +55 11 47 72 72 00  
Fax: +55 11 47 72 72 10  
E-Mail: stauff@stauffbrasil.com  
[www.stauffbrasil.com](http://www.stauffbrasil.com)

## Asia

## China

**STAUFF CHINA**  
Building 1, No. 128, Die Qiao Road  
Jushuo Industrial Zone, Kang Qiao  
Shanghai, 201319  
Tel.: +86 21 68 18 70 00  
Fax: +86 21 68 18 71 36  
E-Mail: info@stauff.com.cn  
[www.stauff.com.cn](http://www.stauff.com.cn)

Further branch offices in Beijing,  
Changsha, Chengdu, Changchun,  
Chongqing, Jinan, Harbin, Guangzhou,  
Shenyang, Wuhan, Xian and Xuzhou.

## India

**STAUFF India Pvt. Ltd.**  
Gat no. 26/1 & 27, Sanghar Warehousing  
Pune - Nagar Road  
Lonikand - 412216  
Tel.: +91 20 6731 4900  
Fax: +91 20 6731 4905  
E-Mail: sales@stauffindia.com  
[www.stauffindia.com](http://www.stauffindia.com)

## Korea

**STAUFF Korea Ltd.**  
105, Hwajeonsandan 5-ro  
Gangseo-gu  
Busan, 46739  
Tel.: +82 51 266 6666  
Fax: +82 51 266 8866  
E-Mail: info@stauff.co.kr  
[www.stauff.co.kr](http://www.stauff.co.kr)

## Malaysia

**STAUFF South East Asia Sdn Bhd**  
No. 8, Jalan SS13/6A  
Subang Jaya Industrial Estate  
47500 Subang Jaya  
Tel.: +60 3 5637 78 88  
Fax: +60 3 5636 78 90  
E-Mail: sales@stauff.com.my  
[www.stauff.com.my](http://www.stauff.com.my)

## Thailand

**STAUFF (Thailand) Co., Ltd.**  
10 Soi On-Nut 74/4  
Pravet District  
Bangkok 10250  
Tel.: +66 2 721 73 23 / 24  
Fax: +66 2 721 73 35  
E-Mail: sales@stauff.co.th  
[www.stauff.co.th](http://www.stauff.co.th)

## Vietnam

**STAUFF Vietnam Ltd.**  
2nd Floor, CT-IN Building  
#435 Hoang Van Thu Street  
Tan Binh District, Ho Chi Minh City  
Tel.: +84 8 3948 10 41 / 42  
Fax: +84 8 3948 10 44  
E-Mail: sales@stauff.com.vn  
[www.stauff.com.vn](http://www.stauff.com.vn)

## Oceania

## Australia

**STAUFF Corporation Pty Ltd**  
24-26 Doyle Avenue  
Unanderra NSW 2526  
Tel.: +61 2 4271 9000  
Fax: +61 2 4271 8432  
E-Mail: sales@stauff.com.au  
[www.stauff.com.au](http://www.stauff.com.au)

Further branch offices in  
Adelaide, Brisbane, Melbourne  
and Sydney.

## New Zealand

**STAUFF Corporation (NZ) Ltd.**  
Unit D, 103 Harris Road  
East Tamaki, Auckland 2013  
Tel.: +64 9 912 1530  
Fax: +64 9 912 1531  
E-Mail: sales@stauff.co.nz  
[www.stauff.co.nz](http://www.stauff.co.nz)



Introduction

Overview

Push-to-Connect Couplings • FF/FU Series

Push-to-Connect Couplings • FH Series

Push-to-Connect Couplings • FO Series

Push-to-Connect Couplings • HP/HU Series

Push-to-Connect Couplings • UX Series

Push-to-Connect Couplings • IA Series

Push-to-Connect Couplings • IB Series

Push-to-Connect Couplings • ID Series

Push-to-Connect Couplings • BP Series

Push-to-Connect Couplings • HC Series

Push-to-Connect Couplings • HD Series

Push-to-Connect Couplings • HUS Series

Multi Couplings • MK Series

Screw-to-Connect Couplings • HS Series

Screw-to-Connect Couplings • PS Series

Screw-to-Connect Couplings • RH Series

Screw-to-Connect Couplings • FT Series

Screw-to-Connect Couplings • HR Series

Screw-to-Connect Couplings • HH Series

Screw-to-Connect Couplings • HI Series

Screw-to-Connect Couplings • HT Series

Screw-to-Connect Couplings • HM Series

Screw-to-Connect Couplings • HV Series

Special Applications

Spare Parts / Accessories

Technical Appendix

Appendix



## Catalogue 5

### STAUFF Quick Release Couplings

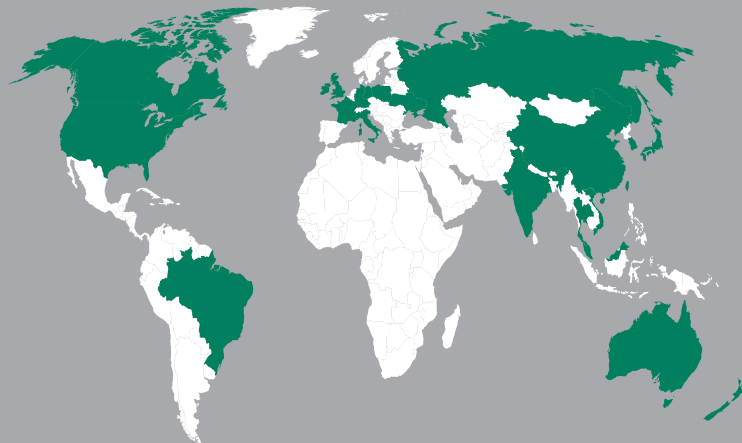

#### Germany

Walter Stauffenberg GmbH & Co. KG  
Im Ehrenfeld 4  
58791 Werdohl  
Tel.: +49 2392 91 60  
E-Mail: sales@stauff.com

STAUFF products and services are globally available through wholly-owned subsidiaries and a tight network of authorised distributors and representatives in all major industrial regions of the world.

You can find detailed contact information on the last two pages of this product catalogue or at

[www.stauff.com](http://www.stauff.com)